

THE PURSUIT OF WISDOM

MY AUTOBIOGRAPHY

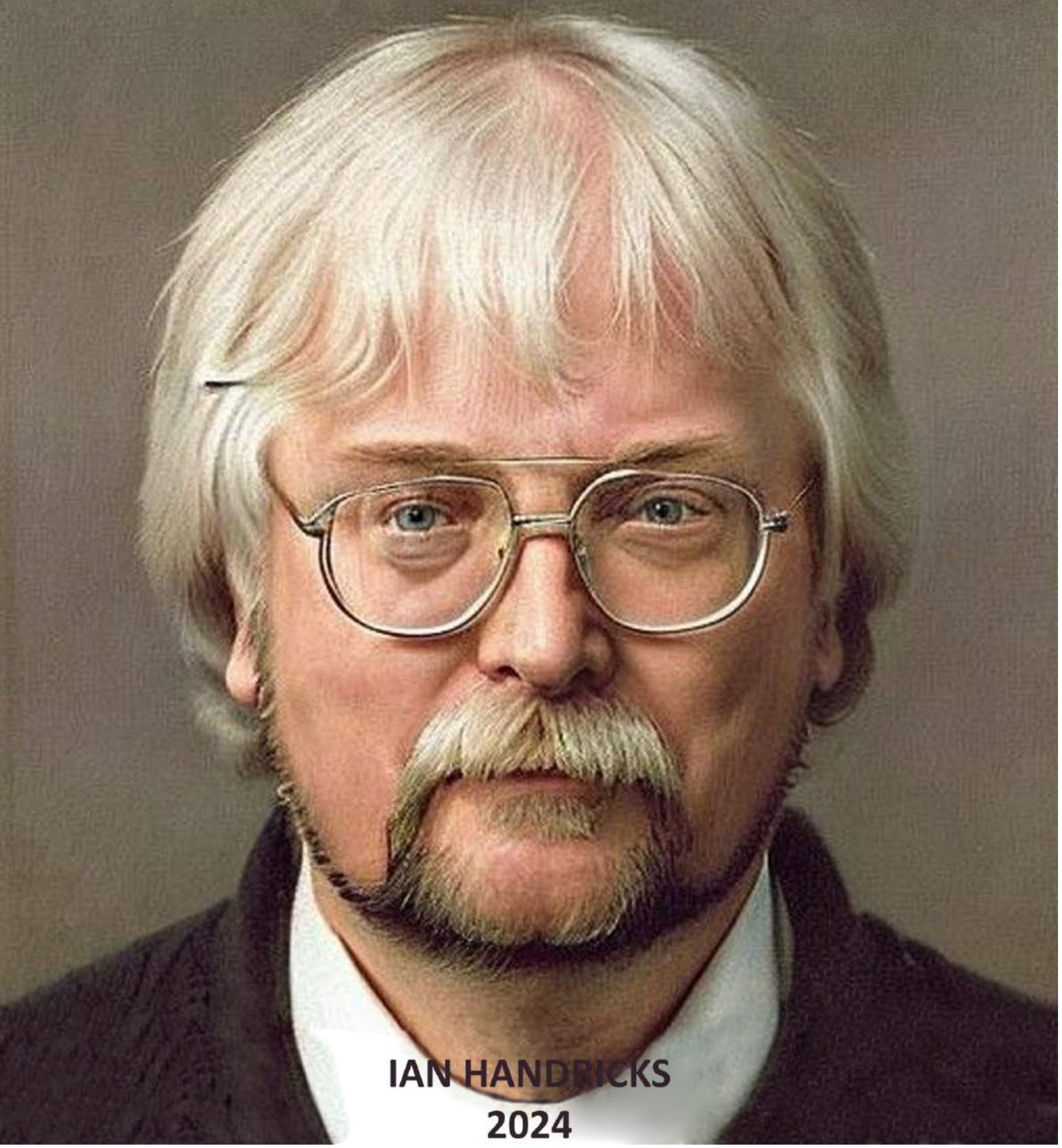

IAN HANDRICKS

2024

PREFACE

I am who I am

I am the product of the rich tapestry of my ancestry
intertwined in the fabric of my environment
and wisdom, gifted by the many people
accompanying my life's journey.

An actor in the theatre of discovery
inspired by the stage managers of knowledge
and sharing the curtain calls of success
with others that have made the performance possible

During my life's pursuit of wisdom
I've tasted the joys of success,
the parched sorrow of failure
and an insatiable desire to help others thrive.

My legacy of discovery isn't a solo voyage
and I appreciate the strength and love
from the people who've shared their love of adventure
and kept me focused.

This is my story.

THE PURSUIT OF WISDOM

My autobiography
Ian Handricks

I was born on Wednesday, 6th July 1955 at home, 9 Farringdon St, Glen Innes, Auckland. My parents were aiming for the 4th July because 4-Square Grocers gifted a full years' worth of groceries to any child born on the 4th July, their anniversary. I arrived 2 days late and my sister, also planned to arrive 4th July, arrived 2 days earlier – no groceries! My middle name is “Lister” named after a small temporary hospital (a converted brothel) in Gisborne where my father, Edwin (Eddie) Lister Handricks, was born in 1926. I was delivered by Dr. Bertram Colman Greenhill L.R.C.P. Edin. L.R.C.S. Edin. L.R.F.P.S. Glasg. and assisted in childbirth by midwife Sister Irismary Bradford-Smith. I was christened on 1st January 1956 at St. David’s Church of England, Seddon Street, Naenae, Lower Hutt, Wellington. My Godparents were Frederick Harris, William Sandison and Maureen Shackleton.



Ian Lister Handricks 23rd July 1955

I never knew my grandfather, my father’s father, Norman Frederick James Handricks, known by all as Norrie, as he died in Auckland of a brain tumour on the 4th September 1936 (my father was 10 when he died). Norrie was a theatrical entrepreneur and promoter and was by all accounts well-respected and well-known in the community. He was born in 1879 Port Fairy, Victoria, Australia to Dutch Jewish and Irish Catholic immigrants, Jozef Levi Handricks and Sarah Elizabeth McKenna.

Our surname was originally “Turfkruijer” dating back to my 5th Great Grandfather, Joel Joseph Turfkruijer (born 1690 in the Ural Mountains of Russia). Joel’s sons, Mordechai Joseph, Levy Joel and Moses Joel Turfkruijer left the mountains and headed for Paris, France where they set up business selling the severed heads from the guillotine. For this activity they were given the nickname “Hangjas” meaning “hang head” or “hang coat”. When the Mob took control the three brothers feared for their life and they escaped northwards to Holland. Two of the brothers were murdered by the Mob and only Levy managed to escape. He settled in Haarlem near Amsterdam in The Netherlands. He stopped using the name Turfkruijer and instead adopted the nickname, Hangjas, as his surname.

Levy’s grandson, Levie Joseph Jozale Hangjas, was born in Amsterdam on 23rd May 1784. He is my great great grandfather. He married Henderijntje Hindele Prins Joseph Welkoomst and together they had eight children including my great grandfather Jozef Levi (Hangjas) Handricks born 30 December 1829 in Haarlem.



Ian - 10 days' old

Jozef emigrated to Victoria in 1860. His naturalization certificate dated 17th Oct. 1863 spelt his first name with an "f" (Josef) and his surname without the "c" (Handriks). It was this confusion with "Hangjas" pronunciation and spelling which lead to "Handricks" becoming the surname. He was described on the certificate as "storekeeper of Ararat, county of Ripon."

ENROLLED by me, in Record of NATURALIZATIONS, Book 14, Page 85 this ~~is~~ the Copy of the said Certificate. One thousand eight hundred and sixty three.

VICTORIA.

No. 85

LETTERS of NATURALIZATION under the Provisions of an Act of the PARLIAMENT of VICTORIA, No. 166.

By His Excellency ^{Charles Darling} ~~SIR HENRY BARKLY~~, Knight Commander of the Most Honorable Order of the Bath, Captain-General and GOVERNOR-IN-CHIEF of the Colony of VICTORIA, and Vice Admiral of the same.

TO ALL TO WHOM THESE PRESENTS SHALL COME :—

GREETING :—

Whereas in accordance with the provisions of an Act of the Parliament of VICTORIA, passed in the twenty-sixth year of the Reign of Her Majesty QUEEN VICTORIA, numbered 166, intituled, "An Act to amend the Law relating to Aliens," Josef Handriks of Ararat County of Ripon in the Colony of VICTORIA, ^{Storekeeper} has presented to me in Council a Memorial, signed and verified upon oath, in the form and manner prescribed by the said recited Act, praying that Letters of Naturalization may be granted to him, such Petition being accompanied by a certificate, as required by the said Act: **And whereas** I, the Governor of the said Colony of VICTORIA, by and with the consent and advice of the Executive Council of the same, have thought fit to grant such Letters of Naturalization to the said Josef Handriks and the said Josef Handriks having taken the oath prescribed by the said Act: **Now therefore** I, the said Governor, do hereby grant unto the said Josef Handriks all the rights and capacities within the said Colony of VICTORIA of a natural born British subject.

Given under my Hand and the Seal of the said Colony of Victoria, at Melbourne, in Victoria aforesaid, this second day of November, One thousand eight hundred and sixty three.

(Signed) L. H. Darling
Governor of Victoria.

By His Excellency's Command,
(Signed) M. Moore

OATH OF MEMORIALIST.

I, Josef Handriks, of _____, in the Colony of Victoria, _____, make oath that the statements set forth by me in the above memorial are true.
So help me God!

(Signed) J. G. Taylor. P.M.

Sworn before me, at Ararat, this seventeenth day of October, 1863.

(Signed) J. G. Taylor. P.M.

CERTIFICATE OF WARDEN, POLICE MAGISTRATE, OR JUSTICE OF THE PEACE.

I hereby certify that I know Josef Handriks, of _____, in the Colony of Victoria, _____, the memorialist mentioned in the memorial hereunto annexed, and have known him for 18 months last passed, and that he is, to the best of my belief and knowledge, a person of good repute.

(Signed) J. G. Taylor. P.M.

Dated this seventeenth day of October, 1863.

OATH.

I do sincerely promise and swear that I will be faithful and bear true allegiance to Her Majesty Queen Victoria as lawful Sovereign of the United Kingdom of Great Britain and Ireland and of this Colony of Victoria.
So help me God!

(Signed) Josef Handriks

CERTIFICATE.

The above named Josef Handriks did take and subscribe the foregoing oath, at Ararat, in the Colony of Victoria, on the seventeenth day of October, A.D. 1863, before me.

(Signed) J. G. Taylor. P.M.

Jozef's naturalization certificate dated 17th Oct. 1863



*My Great Great Grandmother, Elizabeth Cope -
mother of Sarah Elizabeth McKenna*

J. HANDRICKS,
SACKVILLE-STREET,
PORT FAIRY,
IS A
CASH BUYER
OF
**Wool, Sheepskins, Hides,
Tallow, Kangaroo, Opossum,
Rabbit, Wallaby, and Cat
Skins, &c.**
HORSEHAIR IN ANY QUANTITY
(Highest Price Given.)
**DELIVERY TAKEN AT ANY TIME. CASH ON
DELIVERY.**

Jozef Levi Handricks' business advert



My Great Uncle and Great Aunts (Norrie's brother and sisters) - William, Amelia, Sarah and Isabella Handricks

The Ararat Advertiser of 10th June, 1862 lists the marriage of Joseph and Sarah. It states that Joseph was a fruiterer and formerly of Haarlem, Holland and that Sarah McKenna was from Armagh, Ireland. The marriage took place on 7th June 1862. Jozef stated that he was Jewish on his marriage certificate



My Great Grandmother, Sarah Elizabeth McKenna

At the time of her marriage, Sarah's parents were dead. However, she had the permission of her guardian for the marriage. Sarah Elizabeth McKenna arrived in Geelong, Australia aboard the ship "Carleton" from Liverpool, England on 9th July 1857, aged 19. The passenger manifest shows that Sarah Elizabeth was assigned to a "sister, Mrs. Scott in Melbourne".

Jozef Handricks established a business as a greengrocer and was known to have run a boarding house. He was also the local bill-poster and bell ringer, meeting ships at the wharves in his cab.

Jozef and Sarah had nine children. Norrie, my grandfather was the second youngest. Most of the children became entertainers, musicians and theatricals.

The Port Fairy Gazette of 1893 announced the death of Jozef. The Death Notice said that he died on 6th February at his residence, Sackville Street, Port Fairy, aged 55 years. On 7th February there was a lengthy paragraph about his death entitled "A SUDDEN SEIZURE" and on 10th February another lengthy paragraph about him which mentioned that his remains were taken to "the metropolis for interment in the cemetery of the Jews, of which people, Mr Handricks was a member". My grandfather was only 13 when his father died.

My paternal grandfather, Norman (Norrie) Frederick James Handricks was born into a theatrical family – his brother, Harry, was a renowned mandolinist, bell-ringer and female impersonator, his sister, Isabella was a world-famous bell-ringer and vaudeville entertainer.

Norrie’s life-long career was that of a theatrical agent. He was the manager of numerous popular vaudeville acts including bell ringers; The Corricks, Paynes and Belle-Crome families. Norrie travelled extensively throughout Europe, Asia, India and South Africa promoting and managing theatrical tours and seeking out new acts to stage. Later in life moved to New Zealand and became manager of a number of picture theatres. He was an accomplished middle distance athlete and donated the Handricks Rose Bowl for swimming.



From Gisborne press...

Through the generosity of Mr. N. Handricks, whose keen interest in the sport is well known. the Gisborne Surf and Swimming Club possesses an additional trophy for competition this year. It is an exceedingly handsome heavily plated rose bowl, some eight or ten inches in height, of artistic design, and stands on an ebony plinth. This trophy is to be known as the Handricks Challenge Rose Bowl, and will be competed for each season, the winner on each occasion holding the trophy for a year and each receiving a miniature replica of the rose bowl to retain as a memento. The committee wishes to record its appreciation of Mr. Handricks’ valuable gift. The event to which the trophy is to be allocated will be decided at the first meeting of the committee.

On his birthday, 6th Dec 1911 Norrie married Ruby Frances Staggard, daughter of Arthur Staggard and Rose-Anne Haldsworth. Theirs was a happy marriage that lasted 24 years and 9 months when Norrie died from a brain tumour. They had 6 children, five sons (one, William, died at birth) and one daughter – two of whom (Norman and Edwin, my father) continued the family tradition by working in theatre.

Uncle Norman, my father’s brother, had a very long career in the picture theatre business working as manager for many cinemas between Whakatane and Masterton. He was a consummate showman and entrepreneur who won many awards for his creativity and management flair. He was a good man and one of my role models in life. He taught me the value of curtesy, creativity and conscientiousness. I used to love going down to see him and getting involved in his theatre antics. He had a big office with a large desk scattered with posters, accounts, glass slides of advertising that used to be shown during the intermission and all manner of movie memorabilia.



He used to run competitions for the viewing public so that they might earn complimentary tickets. One such competition was to guess the number of windows in the skyscraper for the movie “Towering Inferno” – he placed on the window of the theatre a poster of the movie that showed one side of the skyscraper and so many people fingered the poster’s windows that the poster was worn away (they counted the number of windows and multiplied by four and submitted their result – nobody won because the skyscraper was a five-sided building! Norman died on 27th January 2004 in his 90th year – I learned of his passing when I was in the middle of the Golden Gate Bridge in San Francisco.

Uncle Norman Handricks

Auntie Gwen (Gwendoline Rose Corrick Handricks), my father’s only sister and first-born child of my grandparents, lead a solitary life. She never married and by all accounts never dated. She lived alone most of her life in a small one-room flat in Glen Innes. I can only ever remember her having one job, working in the cafeteria in the roof garden of Farmers Trading Company in Hobson St, Auckland. Gwen never learned to drive and used to catch a bus to and from the city each day. She was a kindly aunt who doted on her nieces and nephews.



Gwendoline Rose Corrick Handricks

Dad's older brother, Uncle Doug (Douglas Hubert Nelson Handricks) was somewhat of a rogue and a man of questionable character. He was regularly in trouble with the law for assault, money laundering, counterfeiting, being AWOL from the army and a host of other offences. He was a bad influence on my father! Together they were frequently involved in not-so-good activities. Doug had a relationship in 1940 with Mauva Beryl Clements and twins were born on 29th December that year, only one of which survived, Yvonne Irene Handricks. The family spent decades trying to track down Yvonne without success until 5 years ago when I managed to find her in California. We have all now established ongoing communication with her.



Douglas Hubert Nelson Handricks



My father's only other sibling was Uncle Bob, Robert Harry Handricks, born in 1920 as one of a set of twins (the other, named William, died at birth). Bob was a cabinetmaker and lived most of his life married to Kathleen in Te Atatu North.

It is interesting to note that neither of my parents ever met or knew any of their grandparents.

Robert Harry Handricks



My grandfather, Norrie Handricks, always did his own marketing and promotions – he is shown here (in panama hat) in two phases of a promotional montage for Lismore Tailors“



Norrie, my grandfather, was always an impeccable dresser, well-mannered and polite. He was a born showman with an acute sense of humour and a relentless self-promoter. Norrie had a good business head and was especially good with figures and he excelled at marketing and advertising – many 1000's of newspaper clipping have been left in his memoirs of his life and theatrical activities. He was a practical joker who enjoyed a good game of snooker. Norrie also maintained an aviary of birds.

From one newspaper article: "Norrie Handricks - One time of Australia, but for some time past one of the "live wires" of Gisborne. At present steers the local fleet of the N.Z. Picture Supplies, Everybody's Theatre, and is one of the best known men in the district. Small of stature, but faces life with a big grin which always carries him through. Looks after the interests of Everybody's well, and is largely responsible for the popularity of the theatre. Is a real "sport" in the truest sense of the word, and has never been known to refuse assistance".



Norrie Handricks

The future Sir Robert Kerridge worked for Norrie in the theatre. Sir Robert started as a "gopher" for Norrie and learned the theatre trade from the master himself. However, it was Kerridge who, at a time when Norrie was at his weakest and was very ill with a growing brain tumour, bought up Norrie's IOU notes around town and then demanded payment from Norrie. He settled by taking over the theatre chain thus ending Norrie's association with the theatrical business. After he left the theatre and before he died Norrie had a number of small enterprises including selling a range of cleaning products door-to-door, selling Art Union tickets and "Tung" oil.

Norrie collapsed at 44 Norfolk St, Ponsonby, Auckland and was taken to Auckland Hospital and then to Greenlane Infirmary where he died of a brain tumour after lingering on for 6 months with a cerebral neoplasm. Norrie never smoked, drank alcohol (although he did drink Sarsaparilla) or used profane language. He wrote in a copperplate style.

Norrie's Obituary published in NZ newspapers read as follows:

News of the death in Auckland of Mr Norman Frederick James (Norrie) Handricks, former resident of Gisborne for many years, will be received with regret by a very large circle of friends in this district. Mr. Handricks had been seriously ill in Auckland Hospital for some considerable time and little hope had been held of his recovery.



My grandparent's home in Gisborne – Norrie is on far right in front of his beloved aviary, my grandmother, Ruby, is second from left – my father, Eddie, is in the arms of the lady 4th from left. The photo was taken in 1929 (Note, the home is still standing in 2022)



Norrie, driving the front car, is leading his theatrical troupe on a New Zealand tour 1921

Mr. Handricks was born in Australia and had been associated with the theatrical profession practically all his life. In his younger days he travelled from one end of the Commonwealth to the other with the Belle Crome Bell Ringers and, later, joined up with the firm of John Fuller and Son. In the employ of that company Mr. Handricks was manager of Everybody's Theatre in Gisborne, now known as the Majestic.

When the theatre was purchased by Mr. R. J. Kerridge, Mr. Handricks was transferred under the Fuller regime to Feilding. After a year or so there it was decided owing to economic conditions, to close the theatre. Mr. Handricks was then installed by Mr. Kerridge as manager of the Opotiki Theatre. where he remained for some considerable time. Ill health, however, necessitated his retirement and, later he proceeded to Auckland, His condition, however, did not improve, and for a lengthy time he had been an inmate at Auckland Hospital, the end coming on Saturday morning. In addition to his widow, Mr. Handricks leaves four sons and one daughter, to whom sincere sympathy will be extended in time of their great loss.



Norrie promoting his theatre "Everybody's" in Gisborne 1932



Norrie's hearse – September 1936

My father's mother and my paternal grandmother was Ruby Frances Staggard. She was born 27 Feb 1885 in Glenferrie, Victoria, Australia to Arthur Staggard of Westbury, Tasmania, Australia and Rose-Anne Haldsworth of Melbourne, Australia.



Ruby Frances Staggard



My Grandmother, Ruby Staggard



Four generations in 1913 - Clockwise from back - My Grandmother Ruby Staggard, my great grandmother Rose-Anne Haldsworth, my Aunt Gwendoline Handricks and my Great great grandmother Isabella Gelley



Mr. HARRY HANDRICKS,
Female Impersonator.

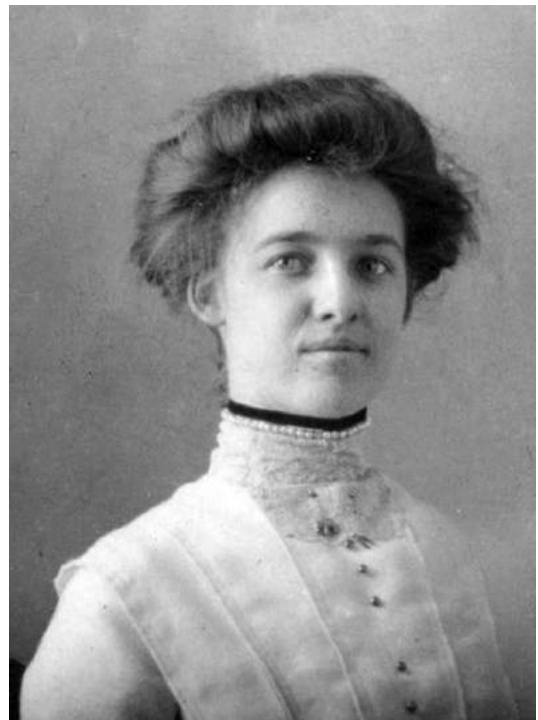

Harry Handricks' sister, my great aunt, and famous entertainer, Isabella (Bella) Handricks



Sylvia, Ruby & Jim Lee at 29 Seabrook Ave, New Lynn, Auckland

Rose-Anne's father was William Edward Haldsworth born 28th April 1837 in Launceston, Tasmania to William Edward Houldsworth and Rose Eliza Wadham.

Rose Eliza Wadham was born in Southwark, Surrey, England on 18 Sept 1806. She was a convict and transported to Australia. In 1830 she was charged with larceny in Surrey and arrived in Tasmania on board "America" in 1831. She submitted a mercy plea. She contacted her parents after being given the death sentence commuted to transportation for life

Eliza Brown was her working name as it seems that she was a "lady of the night". It was this name she gave when arrested. Her convict record says she was born in Kilkenny as does her death cert from info given by James C. Sears (Informant). She had married William Payne before she was transported and had the tattoo of his name on her arm.

William Houldsworth (my great great great grandfather) was first married at Buckley St Manchester to a washerwoman. He was a convict. On the 7th May 1821 William Houldsworth was convicted at Lancaster Quarter Sessions of stealing four pieces of Kersey. He was sentenced to be transported to Australia for 7 years. William was transported on the convict ship "Claudine" which left England on the 20th August 1821 and arrived in Hobart, Tasmania on the 15th December 1821. William's behaviour, according to the Hulk Report, was "Orderly". At this time, he was 19 years of age, 5ft. 3.5 inches tall and had light brown eyes and hair. On October 14th, William was washed and scrubbed by the boatswains for being dirty when he was called for muster time.

His son, my great great grandfather, William Edward Haldsworth married Isabella Gelley at St. Andrews Church, Brighton on 31st January 1859. He stated he was a widower and his former wife had died on 21st November 1858, The marriage certificate gave his occupation as Stock keeper. Isabella had arrived at Hobson's Bay on ship "Garland" in 1852.



Isabella Gelley

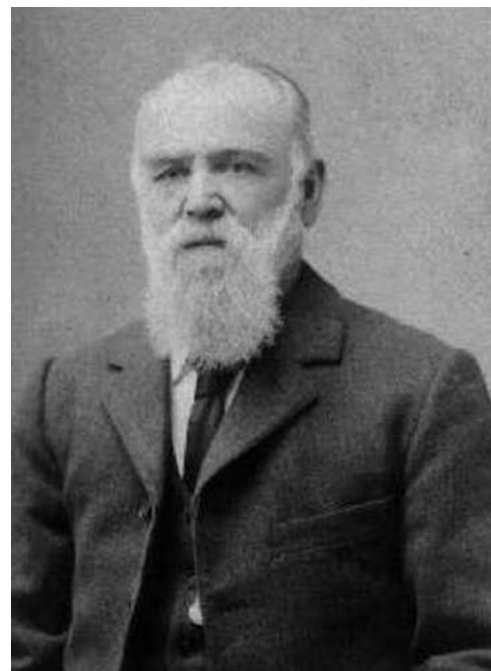

William Edward Haldsworth

Ruby was one of three children and the only one to marry. Her brothers were Leslie Thomas Staggard born 22 Sep 1889 and Percival Arthur Staggard born 22 Nov 1886.



Ruby and her two brothers

Ruby had a positive childhood and enjoyed a family life of relative prosperity. Photographs of her early life show her as a well-dressed lady with a happy disposition – a trait she maintained for the rest of her long life.

She married twice, firstly to Norrie Handricks on the 06 Dec 1911 at Christian Chapel, Church of Christ, Hawthorn, Victoria, Australia and latterly in 1953 to James Gam Lee, a long-term family friend and chef from Wanganui, NZ.

Ruby and Norrie toured together with his vaudeville acts and it was during one of these tours (with the Corrick Entertainers) that their first child and only daughter, Gwendoline Rose Corrick Handricks was born 03 Oct 1912. In 1919 Ruby, Norrie and baby Gwendoline moved to New Zealand. Four sons soon followed (plus another, a twin of Robert, that died at birth) creating a busy household for Ruby.

Norrie's job, managing cinemas, kept the family constantly on the hop around the country. While in Gisborne, the family home became famous for its large aviary which attracted hundreds of visitors. The family was continually on the move, staying for short spurts in Wellington, Palmerston North, Nelson and Wanganui. Ruby was a great correspondent, always keeping in touch with old friends in Australia, and around New Zealand.



Ruby & Jim standing in front of the 1936 Chevrolet Coupe that would one day become our family car



Ruby & Jim beside Doug's Taxi outside 29 Seabrook Ave., New Lynn, Auckland



Sylvia, Doug's step-daughter, standing in the driveway of 29 Seabrook Ave. 1954

Ruby was a cheerful and positive influence for the whole family who maintained relatively good health for most of her life. She was a devout Christian attending the local Church of Christ three times on Sunday. Every other day she would be at the pictures eating her favourite chocolate peppermint creams. She was an excellent story-teller, loved the grandchildren and great grandchildren and she maintained her composure to the end of her life, not ever becoming senile.

She received her telegram from the Queen for her 100th birthday. She lived her later years at 29 Seabrook Ave, New Lynn, Auckland where she and Jim ran chickens and enjoyed the family visits.

Ruby passed away peacefully in her sleep on 19 Jul 1989 at St John's Hospital, Pah Rd, Epsom, Auckland in her 105th year. Ruby's very long life can be attributed to her having a sharp mind, well-developed sense of humour, happy marriages, good upbringing abstinence from drinking, smoking, swearing or gambling.



29 Seabrook Ave, New Lynn

My memories of her include the long drive across Auckland (Glen Innes to New Lynn - no motorways then) every month or so to visit her where she would regale us with stories, sweets and we had fun times in her woodshed and chased after her chickens. I never knew her without a smile on her face and her house was somewhat of a ramshackle but had a great open fireplace in the lounge with old-fashioned bellows, sumptuous couch and chairs and memorabilia from many years of her life. She took a lot of interest in her grandchildren and followed our careers with great interest.



It was in her wooden garage at the end of a driveway, made from old bricks cast at Albert Crum's New Lynn Brickworks, that my father discovered her 1936 Chevrolet Coupe car (it had hardly ever been driven). That car would become our family car – it was a two-door vehicle with one bench seat and a very large parcel tray above the boot. Invariably, my parents sat on the bench seat and us kids lay down on the parcel tray or sat in the boot! In fairness, it was probably the only good car my

father ever owned! He had a run of questionable vehicles – Ford Prefects, Hillman Minxes, Holden and other cars – none of which seemed to run well and were constantly getting repaired. In all those years he only ever owned one new car – A ford Prefect which he sold not soon after buying it to make the deposit on his first house.



Edwin Lister Handricks

My father, Edwin, was born in Gisborne and got his middle name, "Lister" from the name of the hospital (a former brothel) in Gisborne where he was born. Ruby, his mother (aged 41 at that time), was suffering from peritonitis at the time of his birth and in thanks for the staff at the hospital managing to save both mother and child, Ruby name him "Lister".

Edwin attended Seddon Memorial Technical College and later completed an apprenticeship as an electrician. He served during World War II in the Air Force as a ground technician and had a lifelong interest in the theatre, especially as electrical back-stage crew with His Majesty's Theatre in Auckland and a number of other theatres throughout NZ.

He started his electrical career with ECC (Electrical Construction Co.) and later went onto join the Auckland Electric Power Board becoming Chief Inspector for a number of years.

My mother was engaged to Ron Minahan, a stage hand and electrician, however my father, a friend of Ron's, was also very keen on her. So he made a move – sold his new car and purchased the home at 9 Farringdon St. without my mother's knowledge. He then approached her and told her what he had done and asked her to be his wife. She later told me she was upset, confused and felt compelled to end her engagement with Ron and instead marry my father. A decision, she said later in her life, she always greatly regretted.

After my parents married they moved to their first home at 9 Farringdon St, Glen Innes where the three children were raised. They then moved to 9 Dale Cres, Pakuranga and onto Prince Regent Drive, Howick. They then moved to a beautiful home in Papamoa but finally settling back in a converted garage in Pakuranga because they could not settle in Papamoa. Eddie was an active member of the Institute of Electricians (and for a time President of the Institute) and had a pivotal role in the writing of the electrical wiring regulations. In his retirement (and for a number of years previously as a second job) he was a Taxi driver.

Eddie was a heavy smoker all his life and this affected his health. In later years he suffered from poor circulation and was admitted to hospital to undergo a triple A bypass operation, arteriogram and other procedures. Unfortunately, he had his right leg amputated and in his last weeks the other leg was considered for amputation - however on the 1st May 2011 he passed away before this operation happened.

Eddie was a difficult man to live with. He had a temper and could be gruff and moody. He found it difficult to engage with his children and grandchildren. Three years before he passed away, he and my mother split and went their separate ways. Eddie moved from boarding house to B&B and finally settled in a Presbyterian Home for the elderly. The two of them never really had much dialogue after the split. It was a difficult and often unhappy marriage.



The former Lister Hospital, Riverside Road, Gisborne in 2020



The view of Gisborne from the hill behind Lister Hospital

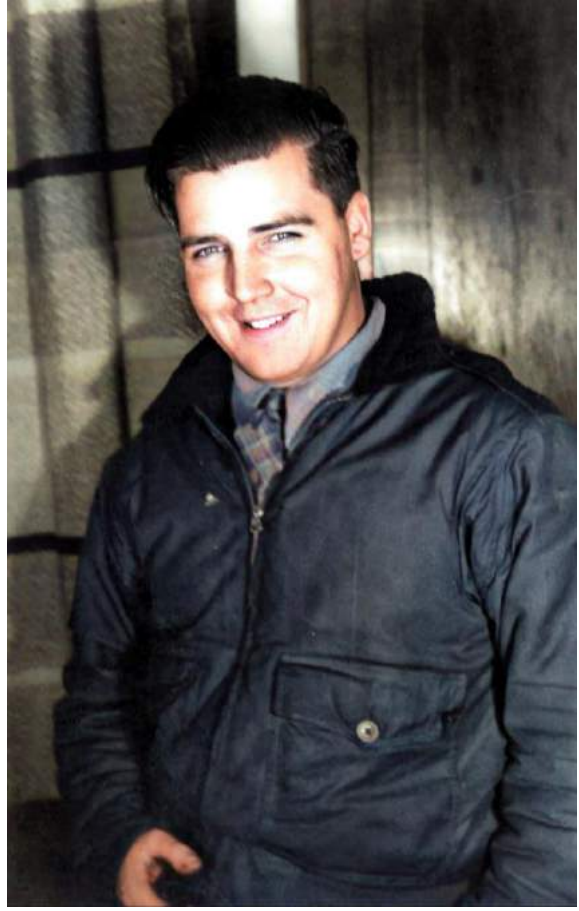

Edwin Lister Handricks



Edwin in Seddon Memorial Technical College uniform 1937

In his earlier years, Eddie had an excellent head for mathematics and would hold an argument firmly. In later years he was forgetful, cranky, argumentative and sarcastic. He slept in late most weekends and was known to doze off frequently during stage performances at the theatre. Never successful with vehicles, virtually every car he owned broke down, cost a fortune to keep on the road or were grossly underpowered for the tasks required of them - he pulled a 10' 6" caravan, the five members of the family and the luggage around New Zealand with a side-valve 1952 10 HP Hillman Minx car!



Eddie fixing the Minx!

I have very few fond memories of my father – he spent too much of his life being angry and on edge. He had little patience and took almost no interest in our activities. We always knew there was significant tensions in our parent’s marriage. In writing this autobiography, I am trying to capture any positive aspects of my father’s influence on our lives.

He undoubtedly had a sharp mind for mathematics – we had a light grey Formica dining room table and after what was usually a quarrelsome dinner, the table would be cleared and out would come his HB pencil and he would drill into me mathematical formulae and problems to be solved by writing maths all across the table. This activity often went on until the early hours of the morning. This activity probably established my abilities in mathematics.



Eddie with Grandson, Daniel



My mother, Norma Margaret Louisa Harris, was born 12th January 1930 at the Alexandra Nursing Home, 28 Hanson Street, Newtown, Wellington to Frederick John Harris and Margaret Miriam (May) Valentine. Both her parents were born in the East End of London, England. Her father was Anglican and her mother was Jewish (although not practising), the daughter of Jewish tailors from the east end of London.

My mother, Norma Margaret Louisa Harris

I only met my maternal grandfather once in 1976. His story and that of the family was sad and full of intrigue. Frederick John Harris was born 15th June 1896 at 3 Lutrauc Rd., Stepney, London, England, the son of a London fishmonger and an Italian opera singer. He was educated at London County Council School. He became a merchant seaman (he later became a Petty Officer with the British Royal Navy (1915-1919)) and a short-order chef, a career he continued on arrival in New Zealand. He married my grandmother, Margaret Valentine on 19 February 1921 at The Registry Office in West Ham, London, England.



My Grandfather, Frederick John Harris

At the time of his marriage he was living at 105 Redmans Rd., Mile End, London and was a fishmonger. In 1926, he and Margaret came to NZ, departing London August 1926, with the assisted passage scheme run by the Salvation Army and settled in Wellington as a chef.

Founder: WILLIAM BOOTH
General: BRAMWELL BOOTH

The Salvation Army
Emigration-Colonization, Shipping and Railway Offices:

International Headquarters
Queen Victoria Street, E.C. 4

Telegrams, Cables, and Wireless
LAUNCHING, LONDON.
Telephone: CENTRAL 1286
(Private Exchange)

MIGRATION HOUSE,
3 Upper Thames Street,
LONDON, E.C. 4.

H.O.5499.

11th August, 1926.

**The ...
Salvation Army**

has Representatives all over the world, and acts as Agent for all the Leading Steamship Companies: gives free and disinterested advice respecting all Countries, and the best and safest way to reach them.

The Army's object is to serve the people, irrespective of creed or nationality. Her unique and unequalled organization has thrown upon her a peculiar responsibility in the matter of the re-distribution of population, and in facilitating movement of the people from

Dear Friend,

Herewith please find letter from the New Zealand Government together with a supply of labels and baggage instructions in connection with your sailing on the s.s. "RUAPEHU"-August 26th from Southampton, also declaration forms which kindly have filled in and return to us immediately with the sum of £24. required for your passage.

Yours faithfully,

In 1943 he invited home for a meal and a night's stay his fellow worker, Jack Wing. Unfortunately, Jack and my grandmother, Margaret, began an affair and Frederick was asked to leave the family home by his wife, my grandmother. Until 1971 this was the last contact he had with his daughter and my mother, Norma. Norma was told by her mother, quite incorrectly, that her father was no good and she should not make any contact with him. Norma was only 12 years old at this time.

After the dissolution of his marriage to Margaret Miriam Valentine, he resided at 33 Epuni St, Wellington and was a civil servant and courier for the NZ Government's Internal Affairs Dept. He commenced with NZ Government Internal Affairs 21st Jan 1941 and then to External Affairs 27th July 1946. He retired 17 Jan 1967 after 26 years' service. His review stated that he was "a highly reliable, energetic and conscientious officer"

Frederick had not seen, nor had contact with his only daughter, Norma from 1943 until a meeting was arranged by me on 7th March 1971 - 29 years without contact of any sort! The meeting was emotional and did much to restore the relationship. Frederick entered the Masonic Court, Clauson St., Palmerston North on Wed 6th June 1973 and died there 17 June 1976.

Margaret Miriam Valentine, my maternal grandmother, married Alfred John (Jack) Wing in 1944 six months after Frederick was shown the door. We grew up being told that Jack was our grandfather.

Margaret suffered a stroke and was left with a severe speech impediment and she had an irascible nature. We visited her at her home, 81 Waddington Drive, Naenae, Lower Hutt at least once a year – it was rarely a happy visit.



My grandmother and Mother in Wellington 1939



Mum - Norma Margaret Louisa Harris





My mother's birthplace - the Alexandra Nursing Home, 28 Hanson Street, Newtown, Wellington



My mother's first home in Holloway Rd, Mitcheltown, Te Aro, Wellington



Mum

My mother grew up in Mitcheltown, Te Aro, Wellington and lived in a home next to the old schoolhouse at the very end of the now famous street Holloway Rd.

She was a sickly child had skinny legs but, even then, had an artistic flair. Because of her poor health, she left school early to become a dancer in the hope that the physical exercise of dance would contribute to better health. She trained in ballet and dance with the Dorothy Daniels Dance Studio in Wellington and progressed with distinction through the grades until she qualified in grade 8 performance, the pinnacle of dancing achievement. Norma appeared in numerous stage productions for a number of years. She travelled extensively throughout New Zealand.

She won awards for her performance and very soon after she left school (at an early age) and began “treading the boards”. She toured extensively and performed in countless productions in a stage career that spanned almost 20 years. Norma had a particular and somewhat cheeky character that could conjure fantasy and she put this into her performance and it became a mainstay of her character throughout life.

In her early twenties she met my father, Edwin (Eddie) Lister Handricks. They met on stage during a performance of “The Boyfriend” – got engaged during a performance of “The Girlfriend” and were married, without a hint of irony, during the performance run of “The Merry Widow”. Eddie located and purchased their first home, 9 Farrington St, Glen Innes. I was the first born and daughter Lynette followed a couple of years later and eventually after a number of miscarriages and battles with anaemia, a third child, my brother Glenn, was born.



Norma always took great care of her appearance, and was considered by most to be up with the latest fashions – how we came to live in an olive green house, with lime green lounge suite, alternating pastel pink and blue kitchen cupboard doors and khaki floor tiles – obviously had nothing to do with Mum’s colour sense! The family grew and all three children married and produced in all eight grandchildren. She doted on them all and they were always guaranteed of her exquisitely wrapped gifts at birthdays and Christmas. The first grandchild and only grandson was my son, Daniel Logan Handricks.

Norma’s second great career was dressmaking and in particular, costume, fairy and fantasy outfits. She had a special talent here and her children were guinea pigs for her early endeavours. Every year we were decked out in costumes for Xmas functions and parties as either scullery maids, cooks, Quasimodo, witches – you name it she could create it! Norma started her own business, "Wandering Star", making and supplying the fairy shop with all manner of costumes, wings, wands and paraphernalia.



Throughout her life, Mum kept a reasonable portion of the house set aside for her dressmaking pursuits. There were shelves and shelves of glitter, sequins, buttons, cottons and other knick-knacks alongside hundreds of packets of patterns, bulks of material, bins of off-cuts, templates and fairy-costume accessories. Notwithstanding this, there were benches and tables supporting industrial sewing machines, overlockers and other equipment used in her craft. She was often commissioned to make all the costumes for big stage shows – I do distinctly remember her making the huge petti-coated dresses for the Can Can – there was bright-coloured gauze, netting and cloth all over the house!

The urge to dance never left Norma. She began again later in life performing ballet in recital and retained her poise and fascination with this art to the end. Through dance and an enduring friendship of more than 50 years ago, she met Pauline Chamberlain. Pauline also shared the passion of dance - and even tried - without success - to teach me how to ballroom dance. In her later years Norma continued to sew and craft her fabulous creations – and enjoyed nothing more than a cup of tea and chocolate macaroon. She had an ethereal spirit, enjoyed doing cryptic crosswords, taught her children to have a sense of fun and to approach situations with a light-hearted and humorous demeanour.



My mother loved her pet cats. We were rarely without a cat about the house. There was “Zibby”, “Clawdia”, “Mousetrap”, “PG” (Pussy Galore), “Ceefor” (you know, A for Apple, B for Bear, C for Cat ...) and many others culminating in her last feline companion, “Horse” – a ferocious monster of aggressive fur and claws who terrorised everyone (except for my mother). My dad had tropical fish housed in a repurposed perfume carboy with a large red bamboo reed lampshade cover.

Mum only had one sibling, her brother and my Uncle Fred. Frederick Charles Harris was born 7th July 1922 at Mile End Rd, Stepney, London and emigrated to New Zealand with his parents and my grandparents, Frederick and Margaret. Uncle Fred was an electrical technician working most of his life with a Palmerston North company, Leader and Watts Ltd. He was a Freemason and rose to a high position in the organisation. Uncle Fred was a very keen radio ham (ZK2AHL) and had an extensive transmitter and receiver set up in his garage. You always knew his home because it had a very tall aerial tower in the back yard.

My parent’s marriage was not a happy one. My father was a difficult man who had a temper, was short-fused and was somewhat disengaged with the family. Although they were married for almost 60 years, Norma asked Eddie to leave after 53 years of them being together. It was an acrimonious split and they really never engaged in dialogue much after that time. Norma first purchased a small house/cottage on the Pakuranga Highway then moved into an apartment and fared for herself (with her children’s support) to the end.



Mum through the years

In July 2011 Norma was advised that she was suffering from terminal Leukaemia and that she would only have a limited time left. She passed away at St Andrew's Hospital, Glendowie, Auckland on 11 Dec 2011 in her 82nd year. Her funeral was held at St Paul's Church, St Helier's and she was laid to rest at Purewa Cemetery, in Meadowbank, Auckland. We decided to farewell her in a style to which she would have approved – we sprinkled a large amount of sequins and glitter from her sewing room on her coffin as it was laid to rest.



I was born in the front room of our home. The house then was a 2-bedroom square dwelling with two East facing bedrooms (front of house) and kitchen/dining and lounge at the rear. There was a T shaped hallway with a bathroom to the left and lounge to the right. A separate laundry sat at the top of a set of concrete stairs leading to the back door. The property was quarter of an acre. My father paid £500 for the house in 1953 (it sold recently for \$1,325,000).

The decoration of the house was certainly different. The bathroom had a black lino floor speckled with random colour bits, the kitchen had alternating pastel blue and pastel pink cupboards, the wallpaper in the hallway was a German special imbedded with sand (it grazed elbows if you were not careful). We had the “Chinese Girl”, a 1952 painting by Vladimir Tretchikoff, in the lounge room. Mass-produced prints of the work in subsequent years were among the best-selling of the twentieth century. The painting is of a Chinese young woman and is best known for the unusual skin tone used for her face—a blue-green colour, which gives the painting its popular name The Green Lady.





Our House – 9 Farrington Street

Glen Innes Intermediate School

Aerial view of Glen Innes



Glen Innes 1959 showing construction of Glen Innes Shopping centre



Mr Samuels - Shop owner in Glen Innes



Glen Innes 1960 showing construction of Glen Innes Shopping centre



*9 Farrington St - Mum and me (in the pram)- 1955
I was born in the front room (nearest to the camera in this photo)*

The telephone sat in the hallway – a black Bakelite model (I still remember the phone number 587-174) and back then it was illegal to transmit music over the phone, toll calls were very expensive and a thick phone book sat alongside to provide a list of contact numbers. We had a Tellus vacuum cleaner (which lasted and performed perfectly for well over 50 years) and an Iron Horse lawnmower, which like my father’s cars, spent a good deal of time in the garage being repaired (it did however, keep on working for more than 50 years as well).

My earliest memory is playing in the front garden alongside a slow-growing yellow-leaved shrub – I was probably 4 years old at the time. I do remember clearly my first day at school – Glen Innes Primary – where I was greeted by my first teacher, Mrs Adams.



My first School photo - 1960 Glen Innes Primary (I'm 4th from left back row)



*The only family photo with all 5 of us
(NIGEL – Norma, Ian, Glenn, Eddie Lynette)*

Life at home was a casserole of eccentricities, 1950/60's culture, theatrics and neighbourhood dynamics. Much of our day-to-day living was determined by my father's irascibility, parsimony and stubbornness and my mother's flighty and theatrical personality. I have many memories of some peculiar habits and unusual activities we all were affected by during our early years.

Some of these included Mum's call for us to be at the dining table for meals – she would rapidly flick the hall light on and off (like a theatre strobe light) and we were expected to hustle to the meal table. The dinner was eaten and was often followed by junket (a questionable watery, milk-based dessert, made with sweetened milk and rennet, the digestive enzyme that curdles milk) that was usually "cured" in the hot water cupboard – the same hot water cupboard where our used newspapers were stacked (and would spill out on the floor each time the cupboard was opened!)

It was only at Christmas that we ever had chicken! Chickens were hard to find, small and expensive back then and reserved only for special occasions. Ours was a "Bell Tea" house – my parents consumed mega-gallons of the stuff and dad always poured it into his saucer and drank from that or worse still, he would dunk his toast and marmalade in his tea before he ate it! Mum collected the tea packet coupons – 1000's of them and when sufficient had been saved, traded them in on some trifling doo-dad of little value!

Us kids were assigned the job of doing the dishes, a task we loathed and tried to avoid. My father was a tyrant when it came to dishes – he would inspect every item to ensure it was cleaned to "his standards" and one item failed to pass his scrutiny, we were at best made to re-wash and re-dry every item or worse every item in the cupboards would be offloaded to us to wash and dry. We were still doing dishes at 11:00pm some nights. A wholly unpleasant memory.

Mum had a large copper bowl in the laundry where she would make marmalade and preserves. These were "vacuum-sealed" in Agee jars. I used to be given the wooden spoon to lick clean.



Me licking the spoon from mum's preserves making (note old Bakerlite radio in background)



Learning to crawl with steely determination!



A genuine cot case!

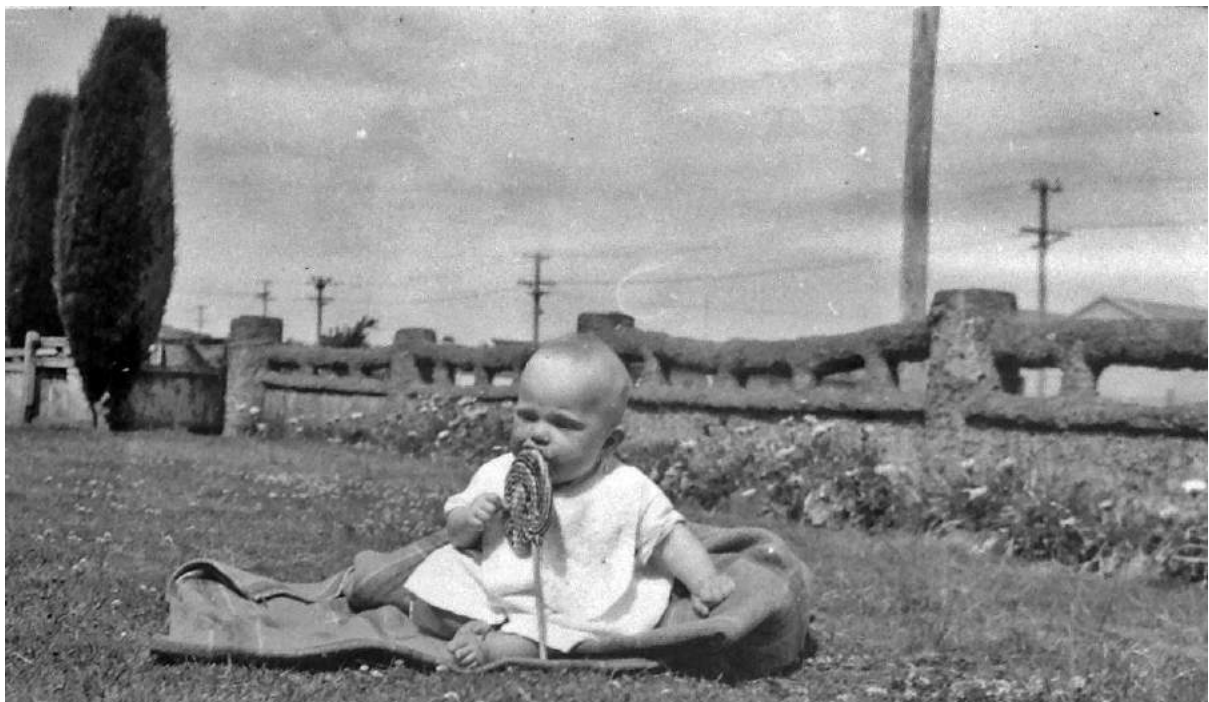

An all-day sucker

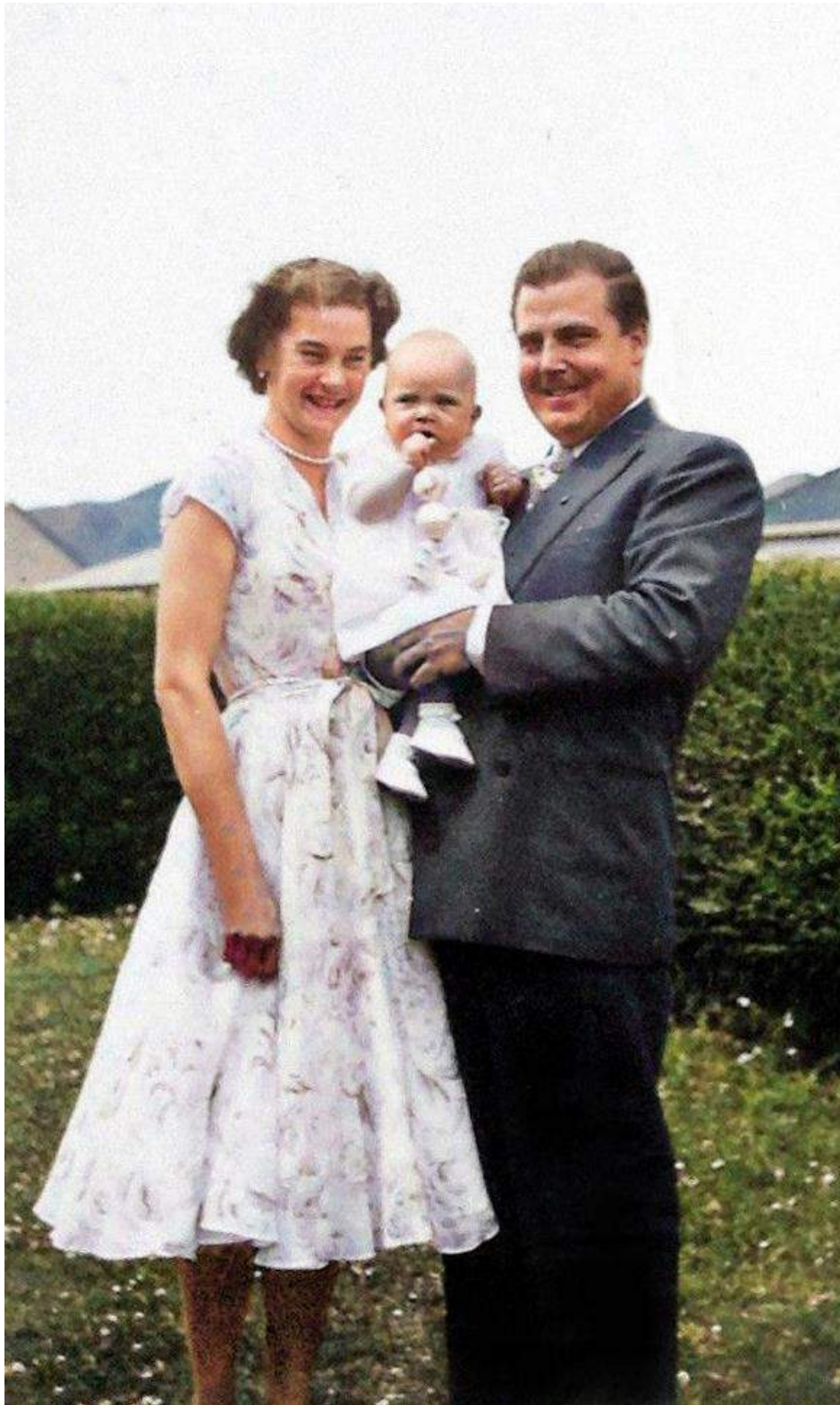

My Christening

1st January 1956 at St. David's Church of England, Seddon Street, Naenae, Lower Hutt, Wellington



Me and dad 1955



Me and mum 1955



*(back row) Uncle Fred, Auntie Aldred, Mum and Dad
(front row) Grandmother, Margaret Wing holding me with Godparents, Mrs Sanderson and Mrs Hubbard*



My 1st birthday cake 1956



Me and "Teddy"



Grandmother, mother and me 1956



My first steps



My first musical instrument

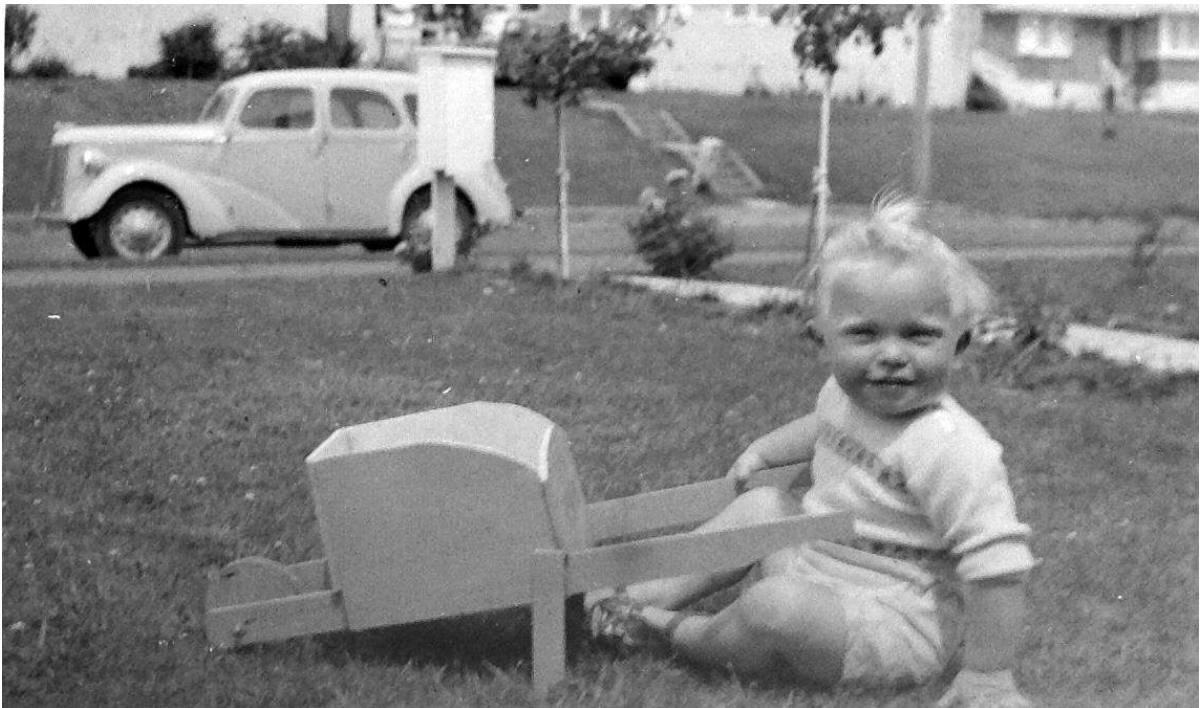

With my wheelbarrow in front garden - note Dad's Ford Prefect in street

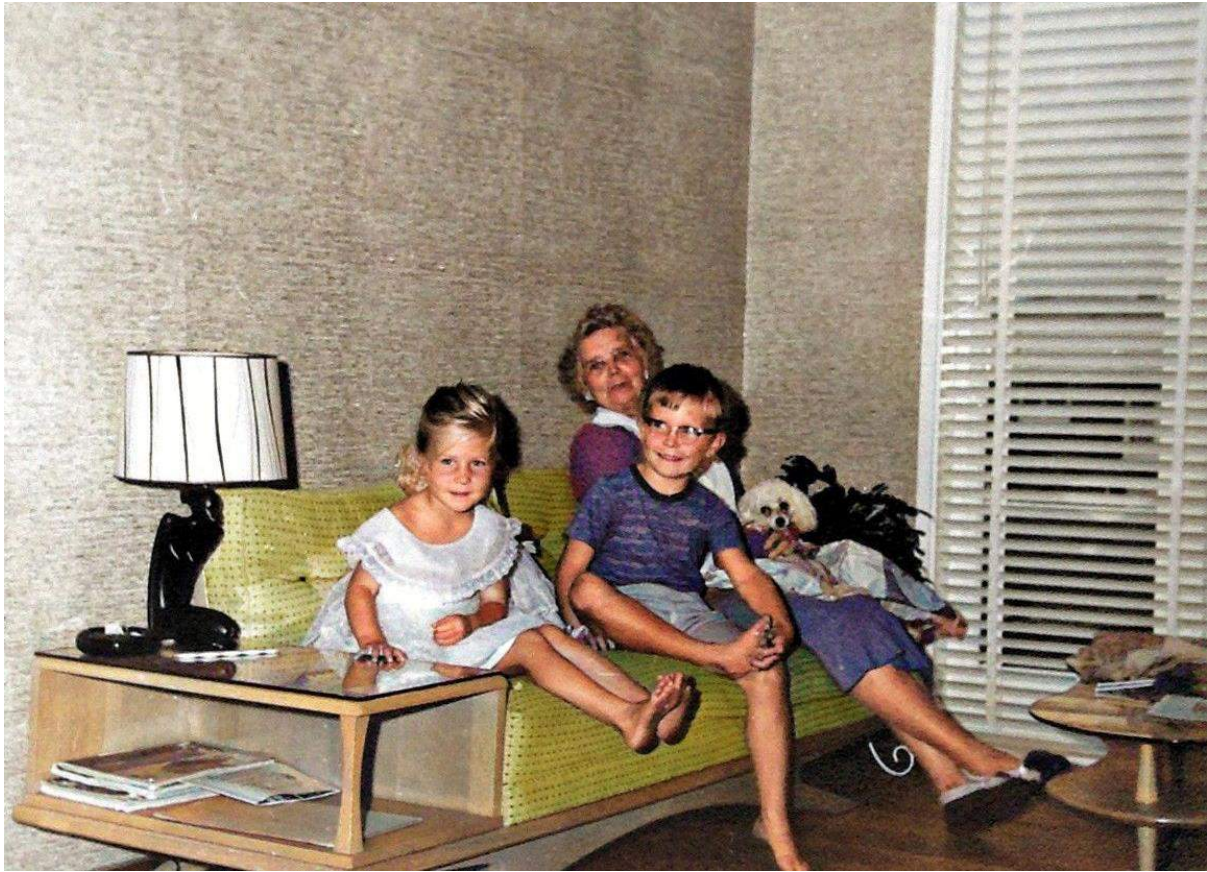

Lynette, Me and Grandma Ruby on the hideous yellow-olive green sitting room couch and the infamous 'sandpaper' German wallpaper on the walls

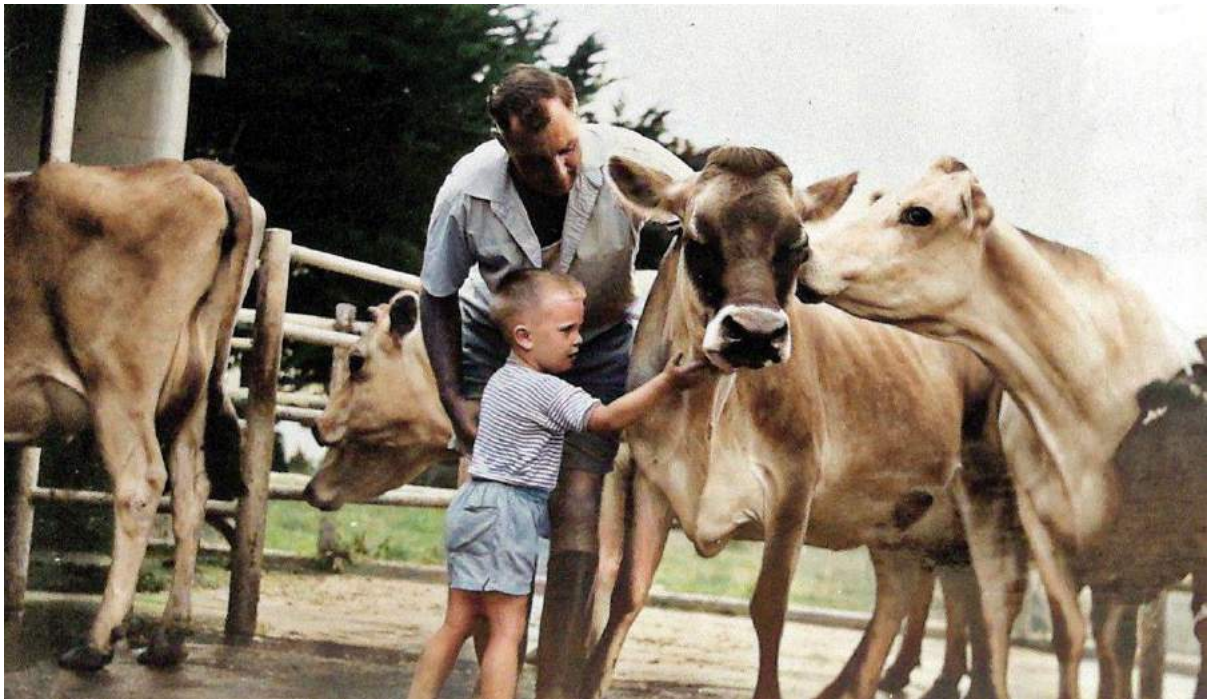

My first ever encounter with cows and my first time on a farm - 1959 Leigh, North Auckland

I have many memories of growing up in Glen Innes. My mother, being somewhat theatrical, gave the name “Nob Hill” to a small cul-de-sac a little way down our street, properly named Greenway Place. This was probably done because she considered those who lived there to be somewhat better-off than we were. At the top of “Nob Hill” lived a schoolmate, Michael Hooker, whose mother used to call him home by standing at the gate and at the top of her lungs yelling “Michael!” across the suburb – it was surely embarrassing for him. Also living in “Nob Hill” was Tui Flower, our doctor’s nurse.

I believe that in the late 1950’s and early 1960’s there was much more of a community spirit – children played outside (usually in the street) and we were not distracted by cell-phones and computer screens (and for that matter not television – it hadn’t quite arrived by then).



We invented games and we associated with other children in the neighbourhood. Playing marbles, knucklebones and hopscotch, building huts, racing home-made trolleys, riding scooters, skipping, exploring creeks and reserves, climbing trees, getting up to mischief, avoiding local bullies, flying kites, playing board games (Monopoly

etc.) and “hanging out” were the things we all did and once home from school (3:00pm) and after re-fuelling with a goodly amount of food and drink we disappeared into the neighbourhood only arriving back home in time for dinner. To my memory, I don’t ever remember any parent worried about where their kids were – today there is a real concern for their safety.

I can remember learning to “tap” the phone in the local phone box to make free phone calls, the pungent smell of the black kerosene-like liquid used to kill weeds in the alleyways (“cuttings”), the equally bad smell of the fennel (the stinky plant being killed by the kerosene), running the hose for hours to create a slippery slide down the back yard (and subsequently raising the wrath of my father for turning the back yard into a mud bath!), exploring the local Winstone scoria quarry, climbing Mt Wellington (our local dormant volcano), building tree-huts, catching hedgehogs, scraping together a few pennies to buy sherbet dabs, chewing gum and sweets from the local dairy and inventing games to while away the hours.



Me catching Hedgehogs! - 1962



Me, age 4 1959



Age 6 1961



My earliest clear memory - Aged $3\frac{1}{2}$ in Jeep pedal car with my sister, Lynette, next to yellow-leaf shrub in front garden 1958

Our family has a background in a number of faiths and denominations – on both my father and mother’s side there is a strong Jewish heritage, more especially on my mother’s side – her grandparents, aunts and uncles were well-known Jewish tailors based in The Mile End Road, Spitalfields, East London (Mile End Rd takes its name from the turnpike in Whitechapel, which stood exactly a mile from the City of London situated at the crossroads where Cambridge Heath Rd meets the Whitechapel Rd. Traders who had come far, bringing their goods to market in the City, would pass through this gate and park their wagons safely upon the wide thoroughfare, spending the night at one of the taverns in Whitechapel, before rising early to arrive in London next morning.) This Jewish heritage and tradition ended with my mother’s mother who decided to ‘adopt’ the Anglican faith (although many Jewish traditions were continued by her – Matzo bread placed on picture frames, separate areas of the kitchen for dairy goods, a menorah always prominent in the lounge room etc.). My surname, as mentioned in the first chapter of this book, has its origins with three Jewish brothers from The Ural Mountains in Russia.

My father’s mother was a devout member of the congregation of the Church of Christ, my father’s father, although of Jewish birth, was a practicing Anglican. In the 1950’s most young families attended the local church on Sundays and many children took part in Sunday School. With a hodgepodge of various faiths in our family, it was decided that we would be part of the nearest church to our home – St Timothy’s Methodist Church, Line Road, Glen Innes (yes, yet a new denomination!). St Timothy’s was a small single building church located on a raised section at the corner of Line Road and Weybridge Crescent, Glen Innes (the St. Timothy’s parsonage was located at 176 West Tamaki Rd).

We had a succession of ministers – the first that I can remember was Rev. John Langley, Rev. McDonald and other fairly old and traditional ministers. Then all changed the day our new young minister, Rev. Brian Turner arrived!



St Timothy's Church Our Home

Brian was breath of fresh air – it was his first parish and a tough one at that. Glen Innes was a hard community of low socio-economic families, many of whom were single parent units, solid working-class and there was a lot of crime. It was not uncommon that kids had guns (and they used them!) and we all grew up being somewhat street-smart and savvy – being fully aware of the violent areas of the suburb. There were gangs and the local hang-out was the Glen Innes pub – a rough, tough and fight-ridden bar where significant amounts of alcohol were consumed. Glen Innes was undoubtedly the “Wild West” of Auckland.

I can remember that one of the first events that Brian organised was the annual church fair – a relic idea from English Village churches – a time when stalls were set up selling home-made produce, nick-knacks and the such along with a variety of games and activities with a modest entry fee – and where the funds collected and earned were used by the church to support its growth and activities in the community. Brian made the bold decision to walk into the heart of the tough areas of Glen Innes and ask the gangs to help organise and run the church fair. Quite surprisingly, they agreed, and turned up on the day (dressed in leathers and patches) bringing with them cookies (with questionable ingredients) and an old bomb of a car for which they charged 50c to hit it with mallet (and \$5 to smash the windscreen!). The fair was a success and raised a goodly amount for the church funds. This was the start of a long and successful relationship between Brian, the church and the tough elements of the community. Through Brian’s efforts the church congregation grew, crime virtually came to an end in the suburb and it was the beginning of a new life for many who previously had no hope or future. During Brian’s time with the church the congregation grew from 16 to 50.



St Timothy's Church in 1956 before the addition of the Langley Block



I was christened on 1st January 1956 at St. David's Church of England, Seddon Street, Naenae, Lower Hutt, Wellington. My Godparents were Frederick Harris, William Sandison and Maureen Shackleton



I was confirmed at St Timothy's Methodist Church, Line Road Glen Innes



I was married at Holy Trinity Anglican Church in Dargaville

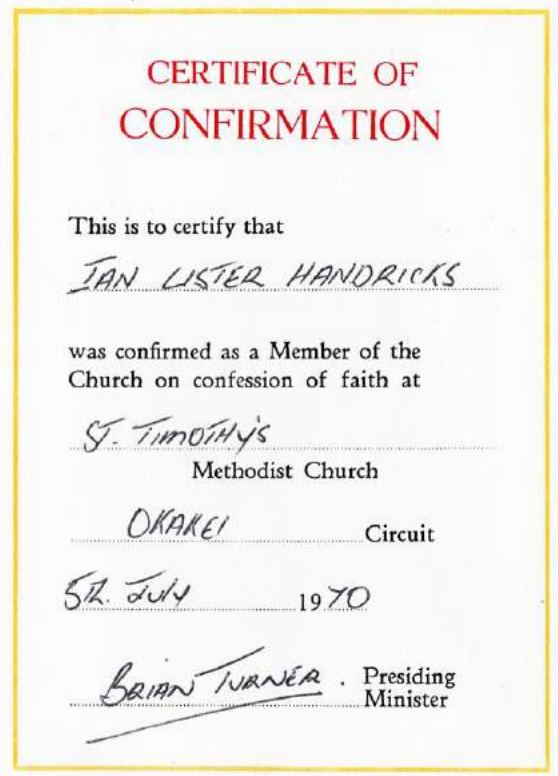
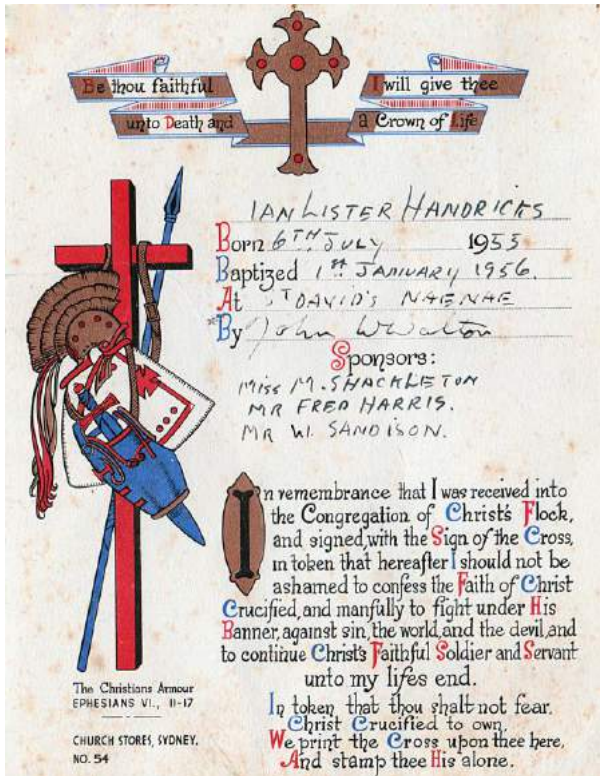

Methodist Church of New Zealand

ORAKEI CIRCUIT, AUCKLAND
ST. TIMOTHY'S CHURCH, GLEN INNES

Minister: Rev. Brian Turner
176 West Tamaki Road,
Glen Innes,
Auckland, 6.
Ph. 583-503

2 June 1972

To Whom It May Concern

Character Appraisal of Ian Lister Handricks

I have known Ian for three and a half years, the duration to date of my Ministry in the Glen Innes Methodist Church.

During that period Ian has encountered normal developmental phases and is at present, in my opinion finding his 'social feet' whilst absorbing and attempting to 'programme' a vast amount of stimulation from intellectual and associated socio-cultural interests.

Included in this stimulation has been the influence of the Church. It was a natural and sincere step, two years ago for Ian to become a Church member, and he has continued to play a role in the life of the Church contributing leadership as a Youth Club executive member (among other responsibilities).

In contrast to what I know of Ian's academic achievements, his involvement in voluntary associations and interests, (such as the Church) seems at present largely determined by the degree to which he can carry people with his ideas and enthusiasm.

Immensely enthusiastic, Ian is a natural initiator rather than consolidator but given support and guidance (when he accepts it) rather than restrictive boundaries, he achieves well as his academic record alone suggests.

Ian's an idealist, an enthusiast, impressionable, cheerful, honest and extremely sincere. He is as I stated, passing through a period of immense intellectual and socio-cultural stimulation. Consequently, it's a little unfair to comment too rigidly on his present state from my somewhat inadequate viewing point.

Given the continuation of the present discipline of academic study, I think Ian's socio-cultural development will settle into a stable pattern.

I greatly admire his sincere enthusiasm.
He will make a significant contribution.
I warmly commend him.

Brian Turner

Some names come to mind – Mr Minifie (a stalwart of the past who believed the Sabbath was sacred and no one should work on that day), Mr Bellhouse (an old and somewhat creepy parishioner who took the Sunday School sessions), Mrs Lillian Henshaw (a curmudgeonary lady - an “Ena Sharples” act-alike - who commanded audience), Rua Turner (Brian’s wife - who



Rev. Brian Turner

played the organ along with Bert Stokes of Mission Bay), Mr & Mrs Easterbrook (kindly and caring couple who lived a couple of doors away from the church in Weybridge Crescent), Mr & Mrs Saunders (members of the church council - also living in a house or so away from the church in Line Road) and Rev. Laurie Greenslade, the area church superintendent.

During Brian’s time and with the community support he spruced up the church inside and out. Glen Innes had many State houses and many who rented state houses took considerable pride in their church which they couldn't do to the same degree to something the state owned. Brian also thought that being located on the rise above Glen Innes, to a degree, made the meeting of those who lived above as well as below the church site more amenable.

Brian did not do this alone – the congregation worked well together, there was good inter-church and inter-welfare agency interaction with monthly meetings to discuss and work at social concerns. The Schools were also an important part of that.

Brian left to accept an appointment in Papua New Guinea and was replaced by a Rev Vickery who had a Church of Christ background. Later, for whatever reason, the Church management decided to sell the property, deconsecrate the grounds and demolish the church to make way for a small housing development. That action ripped the guts out of the community and destroyed the great work that Brian and others had pioneered. I will always and forever be grateful for the wisdom and caring that Brian delivered to the community. He is without doubt one of my most important mentors.



St Timothy's site in 2023



Me on a horse - first and last time!



Me and Lynette with lambs (Leigh 1961)



Me trying to bury my sister head first!



How we crammed into the 1936 Chevrolet

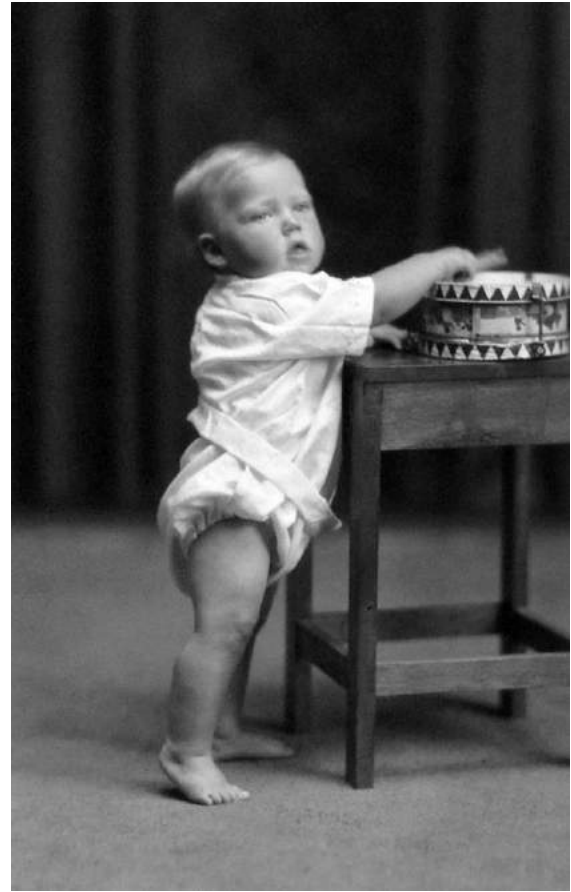

Me and my father in similar poses 30 years apart



Me, Mum, Glenn and Lynette - my first experience in snow (Mt Ruapehu 1968)

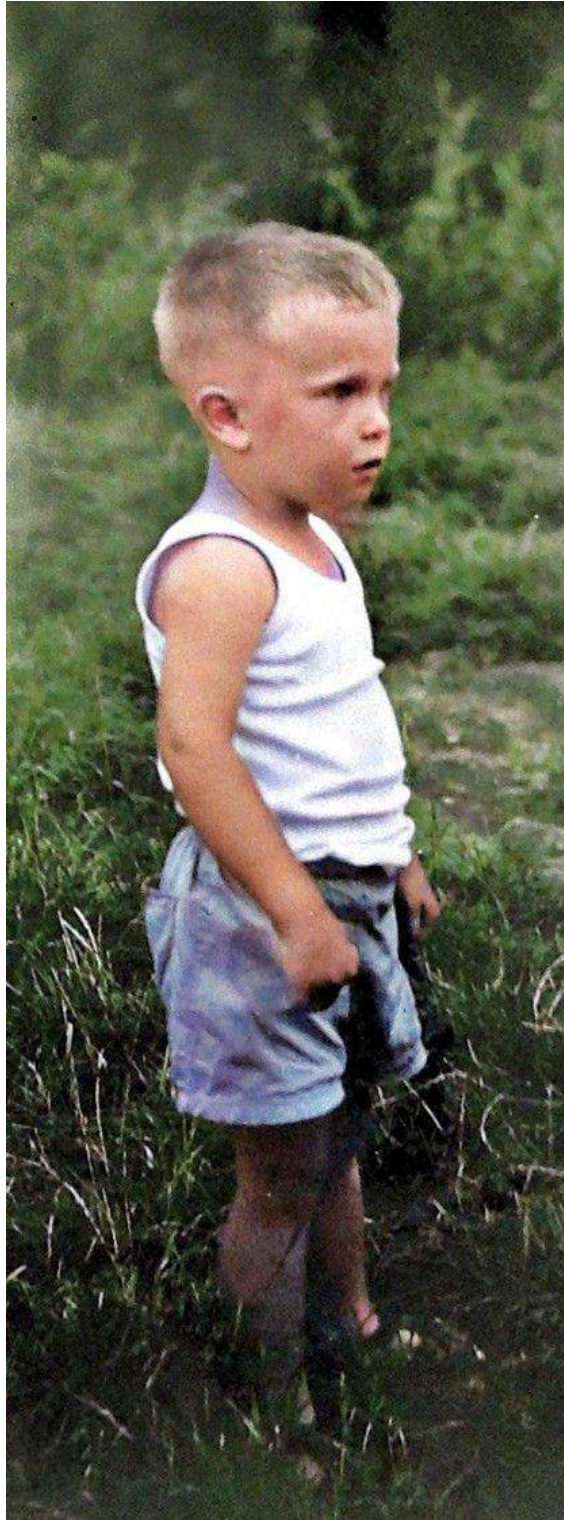

Me - 1958



On tractor with brother, Glenn 1967



Sister, Lynette, Mum, brother, Glenn, and me at Rotorua 1968

At Glen Innes Primary School there were 4 classrooms in the primers block and an arrangement of “Jungle Jims” and playground equipment parallel to them. I do distinctly remember “experimenting” by running at full speed across the playground smashing head-long into the steel bar of one of the playground contraptions – ending up in the nurse’s room with a massive bruise and bulging nose.

I was not kept in the primers for long – I was jumped a class and a half in short time and placed in the “standards” at a very young age (6½) – it seems that I showed some aptitude at an early age. My primary school teachers were Miss Blackmore, Mr Fowler, Mrs English and Mr Bull and the principal was Mr Gillies (who would later become an inspector of schools). Mrs Laver was in the office and ran the Gestetner machine with its distinctive methylated spirits smell!



In Standard 1, just 18 months after starting school. Miss Blackmore was the teacher - I'm far left middle row (note 39 kids in class)

It was in my first year of “standards” that I noticed that I could not read the blackboard. This happened quite noticeably after I’d had a swimming session in the school pool. I was taken to Dr. Lindo Fergusson, an ophthalmologist, who determined that I was myopic (short-sighted) and that I needed to wear glasses. This curtailed any aspirations I had in playing sport – the school was heavily biased towards rugby and kids with glasses could not play!

I was 8 years old when I had my first crush – I was in love with Felicity Mayhew, a beautiful classmate. For a while we were inseparable and we had a lot of fun together.



1965 - My last year at primary school - Teacher was Mr Fowler - note class size 42 pupils! Some names I remember – Dick Otto, Garry Bishop, Wayne Barsby, Glenn Anderson, Bruce Cordes, Morlan Tong, Kay Wolfgram, George Nepia, Georgina Matthews, Alison Moffat, Brian Searle, Peter Smith, Lee Harris, Michael Abernathy, Sharon Clarke, Leonie Dilworth, Russel Pomare & Stephen Fenton



*Glen Innes Primary School 2021
The school motto was "Perseverance Gains Honour" - an adage I have lived by most of my life*



My first classroom (the one with yellow door) - the tree was a sapling back then!

It was around this time that I started to collect postage stamps building a respectable collection (which I still own to this day). I also built a crystal set radio using a real crystal, fine wire to complete the circuit, old World War 2 canvas covered air force headphones and a big black dial salvaged from an old aircraft dashboard allowed me to tune in various stations. – it worked and I remember listening to the radio dramas such as “Dixon of Dock Green” late into the evening.

The school had square dancing each morning on the netball courts, athletic days (I do remember the grass was full of prickles) and choir (heavens knows why I was put in a choir – I cannot sing in any sense of the word!). I remember listening to the Sonny Liston/Cassius Clay heavyweight fight over the Tannoy (speaker system in every class linked to the headmaster’s office) on February 25, 1964 (Mr Gillies, the headmaster, was an avid boxing fan).

We had school milk (usually warm because it was left out in the sun) – it tasted disgusting. However, this lead me to my first business. There was a product called “Make-a-shake” – small sachets of sugary flavoured crystals that when added to milk made it taste pretty good. I obtained a bundle load of these sachets and sold them to other kids in the class. I also volunteered to be a “milk monitor” so that I could collect and deliver the milk from the gate to the class – in this way I could choose the bottle in the middle of the crate unaffected by the sun!

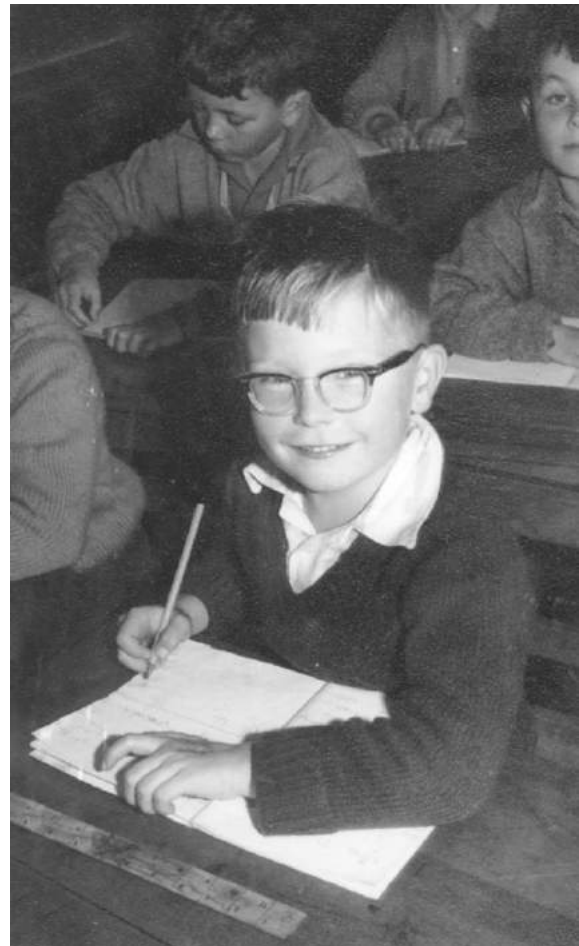

“... we used pencils ...”

We used pencils until we could write at a reasonable level at which time we were awarded the opportunity to use pens. There were no ball-point pens in those days – we had to use fountain pens where we would draw up the ink from a small bottle of ink into the pen and the hope it would work. More often than not we ended up with ink stained clothes, hands and desks! We learned our times tables by repetition (I distinctly remember having an acute difficulty with my 4 times tables) and learned to read and gain comprehension by using a system called SRA – a colour coded progressive reading/comprehension system developed in the USA.

The school had a swimming pool and a dental nurse (in a building known by all as the Murder House) – the dental nurses used low-speed drills and we sat in plywood chairs (akin to a deck-chair), it was not a pleasant experience. There was no school hall (we had assemblies on the netball courts or fields) nor did we wear uniforms.



The disgusting school milk

The Murder House (School Dental Nurse)

Swimming pool

Primers Block

Future Glen Innes Shopping Centre

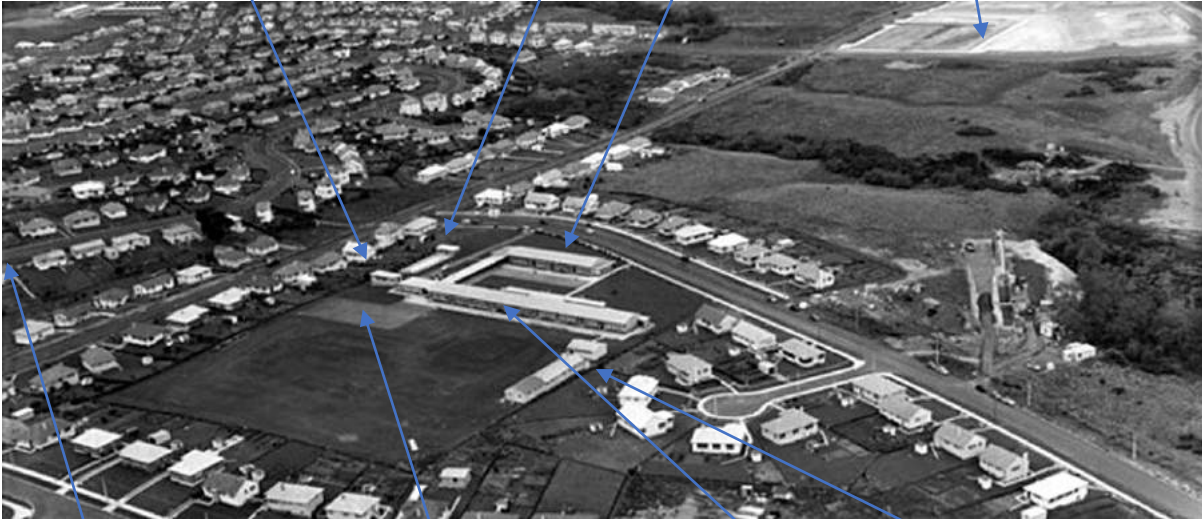

Our Home

Netball Courts (where we had folk dancing)

Standards Block

Prefabs

Glen Innes Primary School - 1960 The year I started there



The crystal set I built



Dad's tropical fish tank with awful red lampshade cover



The black telephone



One of the many costumes Mum made us for various fancy dress events



Me, Auntie Aldred and Uncle Fred (Mum's brother)



Me and Lynette 1959 Palmerston North



Me teaching guitar 1962



More of the outrageous fancy dress costumes my mother created for us – my sister the witch and me the Hawaiian fruit basket (case!)



On the beach with my grandmother, Margaret Wing, her husband, Jack and my Mother and sister, Lynette 1959 – note Jack Wing's knotted handkerchief hat!



Lynette, Mum, Glenn and me at Hell's Gate, Rotorua 1969



Lynette, Grandma Ruby Lee and Me - 1960

Most kids came to school bare-footed and I can clearly remember the black “rompers” (baggy sport shorts) worn by the girls. Although I managed to avoid it, the cane was still used for discipline (usually by Mr Bull). The neighbourhood was rough and tough so discipline was meted out on a regular basis. As a side note, Mr Bull went on to become one of the founding fathers of MOTAT, the Museum of Transport and Technology at Western Springs.

It was around this time (1960) that we got our first TV – I’m pretty sure that we were the first in our street to have a TV. At 7.30pm on Wednesday 1 June 1960, a switch was flicked in the art deco brick building in Shortland Street in central Auckland and New Zealand's first official television transmission began. The only television station in the country was AKTV2 and it only broadcast in black and white between 6:00pm and 9:00pm each day. I also distinctly remember that all of the curtains were shut in the lounge, all the lights turned off and we watched the TV in a pitch-black room. Common thought at the time was that you must sit a certain distance from the TV set or you would permanently damage your eyes! At the time TV was only broadcast in black and white (colour TV did not arrive until 1974) but you could purchase a cellophane sheet with brown, green and blue tinting (bottom to top) which you could overlay on the screen to mimic a colour image.



Lance Revell

In my class were a number of notable kids – Lance Revell (who would become a well-known boxer and promoter/manager), Kay Wolfgramm (daughter of the well-respected and well-known Island musician, Bill Wolfgramm – Bill would become my first music teacher) and Glenn Anderson (son of Bill Anderson, the leader of the Communist Party and active Unionist). Glen Innes was definitely a working-class neighbourhood!

Glen Innes was a suburb well-positioned in Auckland and it began as a new subdivision for first home buyers, however, it was soon chosen as place to build state houses – a vast number of similar designed homes primarily housing railway workers’ families and families of freezing workers based at the Westfield Abattoir in Otahuhu.



Serving tea for my sister (also my first attempt at building furniture!)



First time in the Press – NZ Weekly News 2nd June 1969

Our home and the immediate neighbours were all privately owned homes, however the street (and adjoining streets) soon filled up with state homes.



the Glen Innes shopping centre being built 1960

I remember the Glen Innes shopping centre being built. Occupying fields at the bottom of Line Road the shops soon developed. Mr Samuels who occupied the largest store was a key property owner in the precinct. Alongside him was Marsic Brothers Fish and Chip shop which is still owned and run by one of the original brothers who established the store! Other retailers included Glynn Sheehan's, a haberdashery store that my mother virtually lived in, Boegards menswear, Adams Shoes and XYZ Fruit and vegetable shop run by Mr & Mrs Tong, whose son, Morlan was in my class at school right up until I left High School. He was an excellent chess player. I caught up with him recently – he's now a major mushroom grower.



At age six I started music lessons (guitar) with Bill Wolfgramm in a small room above the record shop in Glen Innes. The first song I learned was "Hang down your head, Tom Dooley". Bill was a kind and encouraging teacher. After Bill, I was taught by Coleen and Barry McIver and then with Neil Colquhoun, a well-known and important music legend of NZ Folk music.

Bill Wolfgramm



My first ukelele



Playing on stage at Tamaki College (far left) as warm-up act for New Zealand entertainers, Lou and Simon 1963

He and his wife, Barbie, became good friends and lessons were held at their home, 45 Chelmsford Ave, Glendowie every Saturday morning. I have a had a lifelong interest in music, especially composing, and to this day I am an avid collector of musical talent. It was around this time (1965) that I did my first public performance playing backing guitar to Lou and Simon (well-known entertainers of the time).

Much later I entered the Hansell's Talent Show at the Easter Show Grounds playing an original composition – I won and ended up performing live on radio (1ZB) with Barry Holland as host from the studio in Durham lane.



Playing guitar with friend, John Leech 1969

At age 7, I started my first real job working backstage at His Majesty's Theatre (both my parents were theatricals) – a job I kept for more than 25 years until the theatre was eventually demolished. During my teens, I also worked at Triang Pedigree (building pedal cars), Ultimate Echo (making electric frying pans), CRC (turning scrap metal into ingots), Klissers Farmhouse Bakery (qualifying as a baker), NZED (working in the Electricity Department's engineering workshops on King's Wharf), running buckle clips (small aluminium clips that hold electrical cables in place) for my father in cob-web infected nooks and crannies (no pay!), Stevens Industries (making de Witts kidney and bladder pills!) and at Edgewater College (teaching music).

My first job in the theatre was moving the spotlights on either side of the stage between acts. After that I was assigned to the Green Room and help organise and deliver to the stage the various props used in the performance. It wasn't too long before I was assigned to the fly floor and became a flyman. The fly floor is the narrow walkway 40 feet up in the air above the stage where all the ropes securing the scenery, curtains, lights etc. are tied off and hauled up and down through the performance. The ropes were made from hemp and about 1 inch in diameter. It was pure muscle power, hard and dangerous work. I completed the last ever apprenticeship offered in theatre craft. I worked hundreds, if not thousands, of performances during my time in theatre and got to meet and work with many famous actors, actresses, singers and entertainers. My only time in front of the audience was in the 1965 Gang Show ... I played the part of a pussy cat! The producer was Ken Maynard and we rehearsed in an old cold and dusty warehouse in Federal Street, Auckland where the Casino now stands. How I came to be on stage when I could not sing, could not dance and certainly not act – is a mystery!

His Majesty's was designed to seat 1700 people in stalls, dress circle and family circle (known as the "Gods"), it had 6 private boxes, a 50ft x 60ft stage, a patented sliding roof and 6 separate entrances. It was designed by the well-known Australian architect and politician, William Pitt.



EDGEWATER COMMUNITY EDUCATION PAKURANGA

PRESENTS ITS

1979

10th Anniversary Course Programme

1969, 5 COURSES OFFERED

1979, 200 COURSES OFFERED

YOUR SUPPORT HAS PROMPTED OUR GROWTH!

- ★ Day and Evening courses
- ★ Venues throughout the district
- ★ Short and Long courses
- ★ Great variety of subjects

New Features WIDER HORIZON PROGRAMME

Include

NEW CRAFT COURSES

MORE COMMUNITY COURSES
SEMINARS AND WOMEN'S DAY

KEEP THIS OUTLINE TO SHARE WITH FRIENDS

Key: EC = Edgewater College
 PCCC = Pakuranga Community & Cultural Centre
 HCC = Howick Community Centre
 OL = Outside Location
 PUFRC = Pakuranga United Rugby Football Clubrooms
 AFTER ENROLLING ATTEND FIRST SESSION
 SHOWN UNLESS OTHERWISE INFORMED



INQUIRIES TO OFFICE, EDGEWATER COLLEGE or PHONE 564-731

108K GUITAR SC 7 p.m.
 322 Wed 21 FEB. 15 wks \$15
 320 Wed 4 JULY 15 wks \$15
 This course is designed for all wishing to learn the guitar, under the
 guidance of Ian Handricks. All who complete the programme should
 have a sound appreciation of the instrument and be able to progress
 further with practice.

EDGEWATER CONTINUING EDUCATION PROGRAMME

BOARD ADVISORY COMMITTEE

PO Box 51078
PAKURANGA

10 April 1978

Mr I Handricks
86 Shakespeare Road,
MILFORD.

Dear Mr Handricks

On behalf of the Edgewater College Board of Governors, I
would like to confirm your being appointed Tutor in Guitar
for the 1978 course year.

The contribution that tutors like yourself make to Edgewater's
Continuing Education Programme largely make for its success.
Thus we want you to be aware that the Board is grateful for
your contribution and hopes that it will go on to be a long term
commitment.

Again, thank you for your being part of the ECEP team, and it is
to be hoped that you have a satisfying and worthwhile year of
tutoring.

Yours sincerely,

Gordon Miles
CHAIRMAN.

THE AUCKLAND OPERATIC SOCIETY INC.

Auckland Arts Centre,
Bowen Avenue,
Auckland 1.

Telephone 375-805 : P.O. Box 2453.



HIS MAJESTY'S THEATRE
3rd - 17th OCTOBER 1981

3rd November, 1981

Dear

Jan

After a tremendously successful season, "ANNIE" is now packed out and on her way to Christchurch, and the Business Manager is ploughing his way through a large pile of accounts, but we have made a very handsome profit on this show and it will give Leslie the greatest pleasure to write a cheque for 50 per cent of the net profit to send to Hamilton Operatic Society as their share of the venture.

As you will now know, this show was the largest technically that we have tackled and it was no mean feat on the part of the backstage crew that this show ran so smoothly.

The Executive Committee are extremely grateful for the part you played in helping to make this show the great success that it was, as without the great team effort put in by everyone backstage, onstage, offstage, front of house, in fact everywhere, we would not have managed to get through. We would hate to total up the number of man hours, the great personal expense and times of frustration over the past few weeks and months.

However we do hope that besides your hard work you enjoyed being part of the team for "ANNIE" and that you will continue to support the Society.

Kind regards,

Yours sincerely,

Sandra

Sandra Sewell (Miss)

SECRETARY

In the late 1960's, I played guitar for a while in the Tzinakis Orchestra. The Tzinakis Orchestra was formed by Gene & Gabrielle Blazer, of French-Hungarian parentage, and who came from a family all of whom were professional musicians.

Gene had played in many orchestras in Europe and since arriving in Auckland, had become a familiar face on the Auckland music scene. He held the position of principal cellist with the Auckland String Players (founded in 1940 by Owen Jensen), which in 1964 became the Auckland Symphonia (predecessor to the Auckland Philharmonia Orchestra), the only professional orchestra in Auckland until 1980. In 1968, Nikos Petousis, then President of the Greek Society, gave Gene a bouzouki so that a small group could play Greek music for them in Danish House (in the suburb of Parnell, at the time). Also inspired by the Osipov Balalaika Orchestra, Gene gathered mandolin, bouzouki and guitar players to form an orchestra. Nikos Petousis gave its name "Tzinakis", which was the name "Gene" with "akis", a term of endearment.

TZINAKIS

ORCHESTRA, SOLOISTS & DANCERS



SAT 16 OCT
His Majesty's

**Exciting music and dances from Greece, Hungary, Israel,
Spain, Russia, New Zealand, etc**

2.15 & 8 pm

I played on stage at His Majesty's Theatre with The Tzinakis



From upper left:
 Gang Show 'Gang', L. Stanton, I. Mansell, C. Power, W. Taylor, R. Fletcher, S. Langdale,
 R. Hingle, J. Maynard, L. Edwards, B. MacLean, B. Emsley, R. Williams, M. Denton,
 P. Burton, T. Hulme, I. Viner, H. Eades, M. Hill, R. Emmitt, D. Digley,
 G. Burton, I. Young, D. Bell, R. Mansell, C. Ziegler, B. MacLean, G. Bell,
 M. Jones, D. Stanton, D. Hutchinson, J. Haytick, S. Ngatai, J. Dukson, R. Leach,
 F. Carlisle, D. MacConnell, A. Brown, K. Hamilton, L. Handricko, T. James, L. Briers,
 J. MacLean, T. Powell, L. Ironside, K. Brown, J. Viner, J. Hardy, M. Barrows.

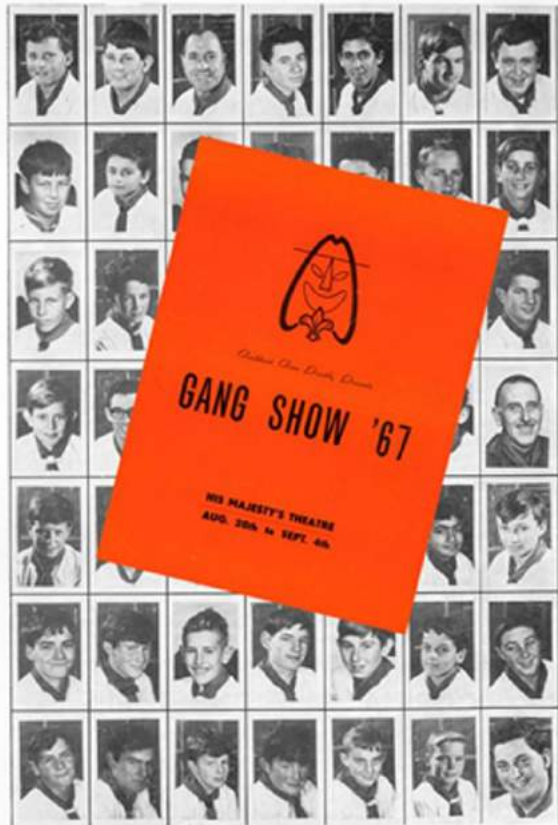

S. Thew, M. Viner, H. Rainon, M. McKinlay, P. Greenwood, S. McNeill, H. Froggatt,
 K. Thomas, C. Wallace, K. Wood, J. Kelland, I. West, S. Hallett, B. Brown,
 J. Williams, I. Ironside, B. Mills, D. Neilson, A. Gee, G. Hartley, D. Brown,
 R. Abbott, J. Hargreaves, P. Neilson, A. Hall, B. Bonfield, N. Wood, B. Viner,
 S. Hayes, W. Johns, R. Pearce, J. Bell, R. Smith, M. Greig, P. Simpson,
 J. Brooker, I. MacLean, F. Pringle, S. Bertram, B. Viner, M. Power, J. Cooper,
 A. Dunlop, P. Clark, G. Lyon, M. Campbell, I. Frayling, G. Page, K. Blizz,
 Absent: R. Sweetman, B. Burton.

*My only time in front of the audience was in the 1967 Gang Show ... I played the part of a pussy cat!
 (I'm in red square)*

I worked on many productions including opera, ballet, plays, musicals and massive international productions. Some notable memories include "Hair" where the stage was bereft of scenery (just an old lorry parked on-stage) but the music was sensational and La bohème where we had a huge revolving stage that one night entangled with the canvas floor cloth leaving the audience viewing a half-rotated scene! I got Chris Swain, my neighbour and future best man, a job backstage and together we worked a number of great performances notable "Evita" which was a hugely technical and massive production – however we both recall it as the most impressive and magnificent show we ever were involved with.

His Majesty's was situated in an arcade that had a Nibble Nook (where you purchased ice creams etc. during interval) to the right of the stage door, a flight of stairs to the dress circle (between the "marble" pillars). The manager's apartment was above that, access to the stalls to the left. There was a massive DC generator under the theatre ... and you had to go into Durham Lane to climb all the way to the "Gods"!

The old His Majesty's Arcade and Theatre Company was taken over at some point by J C Williamson & Son who put the theatre and arcade on the market in 1976. Demolition work began on the night of 23-24 December 1987.



Boy Scouts Association of New Zealand

AUCKLAND AREA GANG SHOW

Producer: Les Maynard,

C/o Scout House,
5 Princess St.
AUCKLAND 1.

Dear Jan

Congratulations you have been selected as one of over 100 members of the "Auckland Gang Show '67" which will be staged in the Playhouse Theatre during the second week of the August school holidays from 28th August to 2nd September 1967.

To be selected for Gang Show is indeed an honour, which I feel you deserve and I hope you will not take lightly because this makes all members of the "Gang" extra special ambassadors for Scouting.

Rehearsals commence (in Scout or Venturer uniform) on Sunday, 21st May at 1.45 p.m. sharp and thereafter every Sunday in 83 Federal Street, (Taubmans Building), City until approximately 4.45 p.m. (bring gym shoes). Extra rehearsals will be held as the show progresses, but you will be notified of these in due course.

Notice is hereby served on you that every member of the Gang including stage crew, wardrobe assistants, etc. will be attending "Gang Show" Camp at Motu Moana from Saturday morning at 10 a.m. 27th May until Sunday afternoon 28th May, concluding at approximately 4 p.m.

I look forward to seeing you again at the first rehearsal - and once more, congratulations. You'll have the time of your life in "Gang Show".

Yours sincerely, in Scouting,

L. Maynard. "Kuaka"
Producer.

Protestors gathered, and the Council inspector was summoned, gaining entry at 1am to tell the workmen inside to cease, as the demolition permit, applied for by Pacer Corporation, had only been lodged the day before. The permit was granted anyway on 31 December 1987, and the demolition proceeded.



The demolition of His Majesty's Theatre - 1987

My mother was heartbroken at the loss of the theatre. I rescued a brick from the demolition site and buried fragments of it with my mother when she passed away.

At Triang Pedigree my first job was outside in the rain dismantling pallets using a claw hammer but I soon learned to weasel my way into a production-line position spot-welding pedal cars. The ladies on the production line at Ultimate Echo loved listening to cricket on the radio – I knew nothing about the game, so they decided to teach me. I have forever since loved listening to cricket on the radio – I think I enjoy that more than watching it! At Ultimate Echo I had the scummy job of testing electric frying pan elements – a hot, smelly and dirty task. Again, I soon cajoled the supervisor into letting me learn how to braze and solder and I ended up assembling the bi-metal contraptions that make electric jugs switch themselves off.

The worst ever job was with CRC – they dumped me in an open, fenced-in stony patch of dirt in the hot sun (with no protection) alongside the motorway at Sylvia Park (long before the shopping centre had been built – in fact it was still the remains of the WW2 American camp).

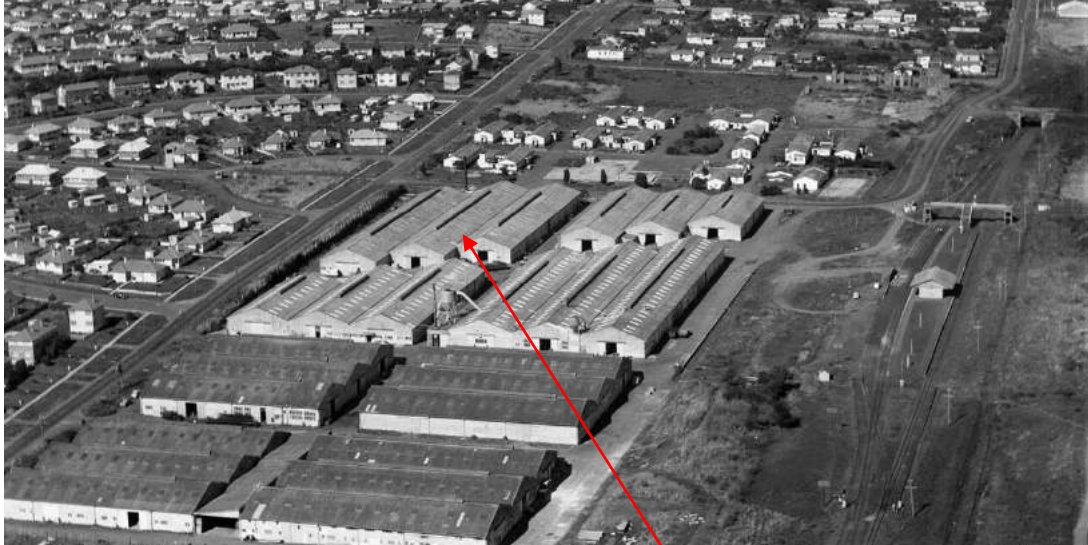

Triang Pedigree - located in the former US WW2 Camp, Camp Bunn, in Pilkington Road, Panmure, Auckland

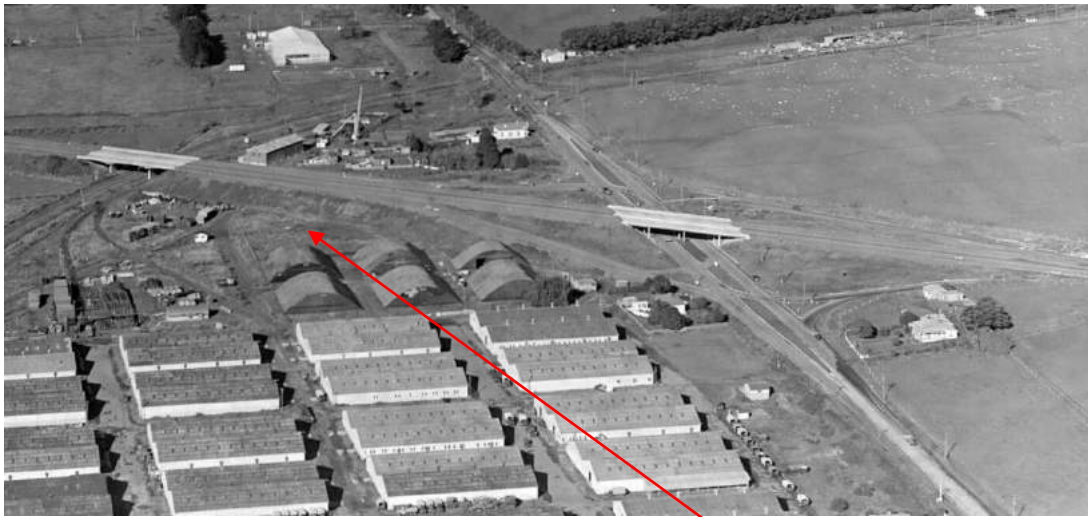

The worst ever job was with CRC – they dumped me in an open, fenced-in stony patch of dirt in the hot sun (with no protection) alongside the motorway at Sylvia Park next to the former US WW2 Supply Camp

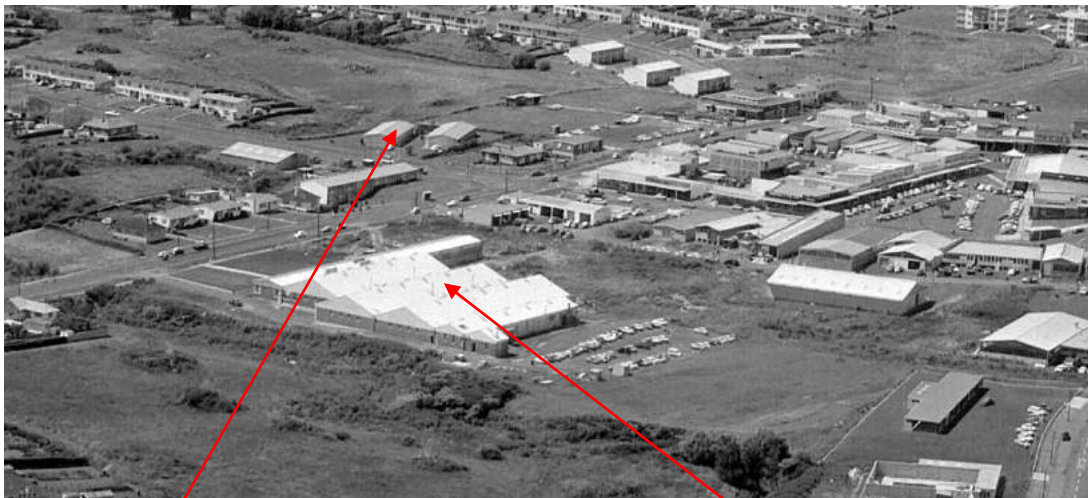

My Aunt Gwen's flat in Taniwha Street

Ultimate Echo in Line Road, Glen Innes

I was given a small blunt hatchet and I was told to cut away the lead covering on the 4-inch diameter electric cable wound around the huge wooden drums that were scattered across the ground. I was left there all day – no water, no food and no way of getting out of there. I lasted 2 days and then quit!



Klisser's Farmhouse Bakery

I became a fully qualified baker during my time at the bake house. I learned how to work the ovens, make plaits, knots and other styles of bread and I spent a great deal of time being the lead baker for Vogel's bread. I was taught by the Dutch bakers who worked there.

The time on King's Wharf working in the NZED workshops gave me the opportunity to learn how to use industrial lathes, how to weld, how to use specialist tooling and importantly how to interpret mechanical diagrams and drawings. In the time there I learned more about practical engineering, fitting and turning than I ever learned at university.

Our neighbours were Alan and Mavis Kyle, a lovely couple who did not have children of their own but instead "adopted" us as their own (there was always a sweet or two when we visited) and Des and Dot Barnhill who had five sons. The houses were new and the gardens not fully developed and the boundary between us and the Kyles would soon have a hedge. I do remember that when I ran across to see Mavis Kyle she insisted that I stop at boundary between the properties and let her lift me across the imaginary hedge! Alan Kyle kept an immaculate property – he was a wonderful gardener and took great pride in his grape vine at the rear of the house – a vine I regularly raided for a tasty snack of grapes!



Mavis Kyle

THE UNIVERSITY OF AUCKLAND

SCHOOL OF ENGINEERING

CERTIFICATE OF PRACTICAL WORK

NAME: IAN HANDRICKS

AT: NZED Dist. W/shops AUCK

PERIOD: 28-11-73 - 29-1-74

NATURE OF WORK (To be classified showing the hours for each classification).	HOURS	
	Ordinary	Over-time
Instruction in use of Lathes Milling attachment thread cutting drilling, and use of grind stones also manufacture of templates. Tuition on electric arc welding etc. <i>Almond</i>	120	
Fabricate of steel insulator Plates & Survey of coal handling equip at Meremere Power St.	110	
Condenser & OCB overhaul at Otahuhu Sub	74	10
314 HOURS DIVIDED INTO :	TOTAL HOURS	304 10

REPORT OF ENGINEER IN CHARGE:

Attendance: Good

Diligence: Very Good

Progress: Good (Very good machinist)

Signature *Almond*

Freeman West

For Office Use

Ref. 168

Completion certificate for the practical engineering experience I gained working at the NZED workshops on King's Wharf, Auckland. The work experience included learning the skills of milling, grinding, thread-cutting, drilling, template manufacture, electric-arc welding, fabrication, condenser and OCB overhaul at the Otahuhu Power Substation and surveying coal-handling equipment at the Meremere Power station.



Alan Kyle with my son, Daniel

Others in the street were Warren and Kathleen Homiston (every birthday and Christmas they would give me a gift of Matchbox cars and additions to the National Geographic Atlas that they gave me when I was just 6 years old), Mrs O’Conner, Beverley and Graeme Rich, the Smythe family, Mrs Barrett and her daughter Wendy, The Belsham family (son’s Danny and Michael). Others in the area included Lee Harris, Michael Hooker, Mrs Tui Flower, The Woods family, Mrs Henshaw, Alison Pink, The Brownhills, Bruce Cordes, Stephen Fenton, Gary Bishop, Peter Phelan, Russell Pomare, Dick Otto and the Blackmores. Christopher Swain who would become my Best Man lived next to the school – I am still in close contact with him 65 years later!



Farrington St Shops 2003

At the top of our street was a small strip of shops including a dairy, greengrocer, chemist, 4-Square grocery, bakery and butcher. The chemist was Mr Broom, a gentle white-haired man, the greengrocers was owned and run by Mrs King and her son. The butchers shop had a deep covering of sawdust on the floor (presumably to soak up any blood that dripped upon the floor) and back then butchers chopped up meat on big wooden blocks that would hardly pass a health inspection today. The grocery store had a black pushbike with a large front-mounted basket for deliveries (similar to the one used by Granville in “Open All Hours”), biscuits were not in packets like they are today – they were in large tins and the grocer counted out how many were required into brown paper bags and greengages, Whittams fish paste and other delicacies were commonplace. The grocery store was a meeting place for many housewives in the neighbourhood – supermarkets did not exist back then. Also back then, empty bottles could be returned to the dairy where you could earn tuppence for each bottle – local scamps used to return bottles, get paid, then hive on to the back of the shop and nick the same bottles to make another claim – perhaps an early example of recycling! We frequented these shops regularly and it was here that I saw my first television and exchanged some old coins for the new decimal currency on July 10 1967.

Many services were provided by trucks driving down our street on a regular basis. We had a blue haberdashery truck (My mother spent many hours rumbling through what they had on offer), a fruit and vegetable van, mobile library, milk delivered to the door (in 1-quart glass bottles) and bread delivered to the bread bin at the top of our back stairs. Not to mention that in those days Doctors made house calls!



Line Road reserve - immediately around corner from my house

Surrounding our home were a number of reserves most of which had a small creek full of frogs, eels, rats and mice (along with broken glass, rusty wire and other nasties) – none of this, however, stopped us from tramping through these creeks, collecting the monkey apples growing prolifically in the hedges and crawling through the slimy-green culverts that ran under the streets next to the reserves. We were walking targets for every kind of infection! Back then parents did not seem to care where their children were so long as we were back by dinner time. A common sound in the area were the regular explosions detonated in the Winstone quarry in Mt Wellington.

I grew up with the usual assortment of trolleys, tricycles, pedal cars, push bikes and scooters (yes, they were popular way back then!). I spent time building huts in the huge macrocarpa trees we had at the bottom of the backyard. After years of trying to prune them back and little interest shown by my father in controlling their growth, I eventually decided to chop down the macrocarpas (they were at least 80 feet high) and incinerated them on the property – black smoke grew out of the bonfire many thousands of feet in the air. Fire engines were rushed to the property to extinguish the fire and I suffered the ire of my father. But at last they were gone and a new life was brought to the back garden. The neglected fruit trees now began to provide fruit!

I was also a Cub and then a Boy Scout in the Glen Innes (Tamaki) troupe. At first we met at a local school with an Akela, a kindly woman who lived in Pt. England but later, after a large number of bottle drives and fund-raising efforts, a large Scout Den was built in Taniwha Street just around the corner from Line Road.



Me in the Macrocarpa 1959



Glen Innes Scout Den, Taniwha Street (now demolished)

I helped in the building of the den and was present for its opening – it had a sawdust floor because the funds were not available to lay a concrete one. I went on camps and earned many badges. Many years later I completed an Outward Bound type operation held at Pakiri Beach run by an ex-cop, Ken Harris. We trekked for miles, scrambled around the ocean-facing rough cliffs (I scraped half the skin off my legs in the process!) and learned survival skills. It was tough but almost certainly good for my character. I eventually went on to help build the chalets on the beachfront with Ken Harris and his business partner.

My next school was just a few doors up the road from our house, Glen Innes Intermediate School. It provided education for Form 1 and 2 and acted as a prep school for college. I was placed in the “A” stream with Mr Ward as my teacher. He was great influence taking a keen interest in our education and adopting innovative learning programs. Science was his forte and much of our class time was spent in experiments and activities of a scientific bent. I do remember that we had two pet rabbits (named John & Yoko) in the classroom hoping that with our care and attention they would eventually mate and have baby rabbits ... however we soon learned that they were actually John & John!

Other teachers included Mr Peacock, Mrs Penman, Mr Mills and the headmaster was Mr Galbraith. The rough neighbourhood made up most of the classes and although it was a co-ed school, the playground was divided in two with boys allowed on one side of the demarcation and the girls on the other.



*As a scout
note yellow-leaf shrub a bit bigger now!*



Our house (9 Farrington Street)

Glen Innes Intermediate School

Glen Innes Primary School

Photo taken 12 December 1961

It was intermediate school that I had my first experiences in practical skills – I learned woodworking and metalwork (these lessons back then were only available to boys – girls learned cooking and home economics – skills education not available for boys!).

My eyesight prevented me from participating in sports, so instead I took a more active interest in mathematics, music and design. I seem to remember that it was around this time that I started experimenting with sketching ideas – some quite obscure – and for the first time realised that my future lay in getting an education.

Glen Innes was a rough and tough community and many of my classmates were out and out bullies. I became street-smart and learned that avoidance was significantly easier on the body than confrontation. I volunteered for any job that would allow me some form of refuge – I landed the job of bike monitor (guarding the bicycle shed from thieves and vandals) and this kept me well-clear of the tougher element in the school.

Glen Innes Intermediate School was closed and disestablished on 12 May 2003 by the then Minister of Education, Trevor Mallard.

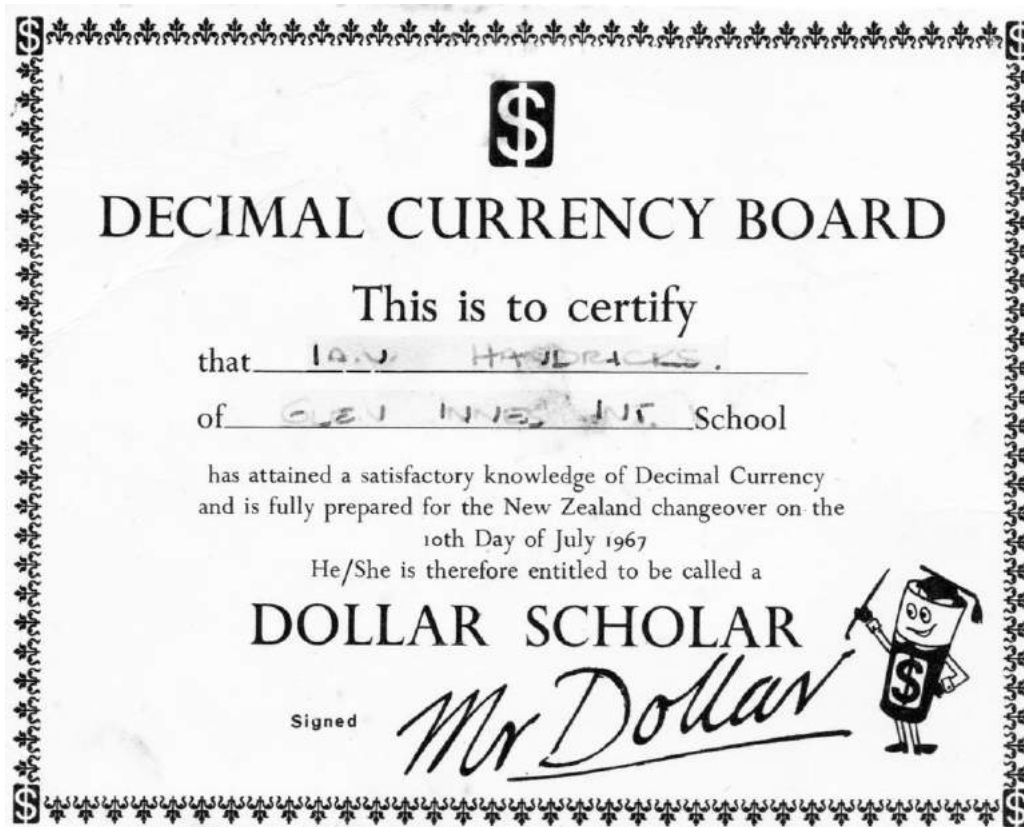

It was at this school that a singularly important influencer entered my life. Mr Crossman. He was an aging relief teacher with slick-backed grey hair, a gin nose and gruff voice. He walked into our class stating “Gildies, Ghosties, long-legged beasties and things that go bump in the night – I am going to teach you to have a passion for education”. He asked us to go to the school library and bring back to the class as many books as we could carry (we were only allowed one book at a time from the library). We followed the instructions and the class was swimming in books. The headmaster soon appeared and reprimanded Crossman for the action – Crossman simply said “Get out! These books are better in front of these children’s eyes than gathering dust on those library shelves”!

Many kids in the class smoked cigarettes. The next day Crossman arrived in the class with some newspaper and a NZ railway tea mug full of a foul-smelling substance (hot roading tar and hydrogen sulphide [smell of rotten eggs]). He laid the newspaper out on his desk and poured the black and smelly contents onto the newspaper saying in a rasping voice, “this is what they scrape out of your lungs each year if you smoke!”. Not one kid in the class ever smoked again!



Crossman taught me the value in bold adventures in learning, to have an inquisitive mind, to use spectacular technique when you need to deliver a message and to understand the wealth that knowledge can bring to your life. He ignited in me the energy to be wildly successful.

These experiences triggered in me probably the most pivotal event in my life – a decision to give myself a set of rules by which I can live my life. I was just 12 years old when I sat down on the cold concrete steps leading to our back door and developed the rules:

1. I will never drink alcohol
2. I will never smoke
3. I will never lose my temper
4. I will demonstrate kindness to all
5. I will show gratitude
6. I will read a book each day
7. I will learn something new each day
8. I will de-emphasise money and instead concentrate on living a fulfilling life
9. I will try and help people whenever I can
10. I will have a passion for learning

I am proud to say that I have stuck to these rules throughout my life. Yes, I’ve made mistakes (some pretty big and hairy ones!) and I could have done a lot of things better than I have, but I have adhered to these rules. The greatest thing I have learned in life is that true wealth lies in having wisdom. I’m not sure why I had this epiphany moment nor why it happened at such a relatively young age.

On reflection, it may have been the perfect storm – a difficult father, adolescence, a desire to be independent, Crossman’s inspiration and the burgeoning 60’s generation revolution.

We must all acknowledge that making our way through life, day after day, is a huge undertaking – it is riddled with roadblocks, unexpected difficulties, a relentless pursuit of money to fuel our living expenses, seeking relief from the mundane and boring day-to-day activities, ensuring those around us are safe and happy, constant decision making, enduring a competitive workplace and all the while trying to find a moment to rest and enjoy peace and quiet. Furthermore, we are pulled from here to there by societal pressures – increasing costs, rampant housing costs, traffic congestion, workplace bullying, COVID ... this can be a never-ending list.

However, within ourselves we have a ready-made solution that can define the way we can lead a happy and fulfilling life. A mechanism which makes us who we are and powers the way we live with each other. It is a quality of spirit that we all possess but most often have never considered nor discovered and yet it can provide the key to riches beyond our wildest dreams.

These are your assets! Assets are those life forces which define your character, give you a unique advantage, guide your personality and are the energy source of your existence. Assets are not skills, like the ability to play a piano, speak a language, play a sport or build a house – they are the essence of your personality which can be used to affect change.

I discovered my assets around this time – the ability to immediately see a solution to a problem before working on the problem and the ability to speak on almost any subject without preparation, without notes and usually with no pre-conceived ideas of the subject. The reason I chose not to drink alcohol in my rules was that I realised that I needed to protect these assets as they would form the foundation on how I would make my living.

My second year at Glen Innes Intermediate School was spent in the “A” stream with Mrs Boegard as my form teacher (she was the wife of our local menswear store owner).



Row 4 Ian Handricks Michael Dolan Allan Rodgers Brenda Ellis Lenore Dilworth Garry Bishop Peter Phelan Eddie Darvil
Row 3 Ricky Taine Chris Swain Wayne Barsby Russell Pomare Michael Hooker Peter Twine Glen Anderson Andrew McNicholl
Peter Lewis
Row 2 Sharon Clarke Elizabeth Sommerville? Christine Barnet Heather Foulton Linda Adams Marion Payne Rochelle Anderson
Christine Mocaraka Lynette Hood
Row 1 Lorraine Johnston Delwyn Taylor? Christine Law Christine Rudman Deborah Sims Raweym Enright Lesley Cotter Helen
Brabazon Ellen Burrett Sandra Keesing
GLEN INNES INTERMEDIATE SCHOOL F2 1967

Around this time, we started travelling around New Zealand with a small caravan. It was only 10' 6" long and as was the norm, my father used to tow it with a seriously under-powered side-valve, 10 horsepower Hillman Minx car. Into the car we packed the five of us, our luggage, food, etc. and headed off for some random destination. We hadn't travelled more than a few miles before the radiator was boiling, the brakes failed, an axle broke, the head cracked or some other mechanical failure stopped us from moving on. These breakdowns happened every trip and became costly and frustrating. None of us enjoyed being stuck in some tin-pot township with a broken car, a distraught mother and an angry father. One year we ended up in Ohope with the car being repaired in Tauranga – a daily hitchhike for my father to the campground to the garage and another year we were stuck in Taihape with nowhere to stay. These were never happy occasions.



The caravan and Hillman Minx

The car still had flippers for indicators (which mostly did not work), a blue light on the roof to indicate we were towing something, and a valve radio (which mostly did not work as expected). To add to the misery of these camping holidays, Dad would smoke (in fact chain smoke) the entire journey with the windows wound up. We choked on the disgusting fumes.

Us kids were assigned to sleeping under the awning that swung off the caravan – no mattress, just a leaking airbed which meant we were sleeping on rocks most of the nights. As per normal we were assigned to the kitchen for doing the dishes (an equally unpleasant experience we had at home!).

Often we were made to crouch down in the car when entering a campground so the proprietor would not see us and we would be charged less for our site. Although we did see a good deal of the country it was not always a pleasant experience. The continual breakdowns, being flooded out of the awning in Rawene, arguments and being stuck in remote places with no means of getting out all lead to experiences we would rather forget.



There were a couple of notable events – we were stranded on the hill near Omapere in Northland. The car was so under-powered it could not move. With the five of us, a heavy caravan, all our luggage and supplies it looked as if we were there for some time. Dad climbed the fence of a local farm

and managed to get the services of the 12-year-old farm boy who, with permission of the local constable, managed to hook our car attached to the caravan with all of us on board to his father's tractor and he hauled us kit and caboodle up and over the hill. He asked for £10 for the service (it appeared that he did this frequently!).

The second event was even more interesting. As was my father's normal action we left for our holiday on Christmas Day (imagine how much we enjoyed missing Christmas dinner and gifts etc!). We had only managed to get to Maramarua (a few miles south of Auckland) when the radiator started to boil and we were forced to stop and get some water for it.

It was at 2 minutes to 12 noon when we pulled into the petrol station at Maramarua – not wanting any gas or to spend any money – just to get water. An elderly grey moustachioed man came out to greet my father locking the service station door behind him. He beckoned my father to walk around the back of the station – we were quite concerned sitting in the car. My father came running back a few minutes later saying that we all had to get out and come down behind the station. It turns out that the old man who greeted my father was none other than Leo Fowler, a well-known New Zealand author. He and his family had decided that whoever pulled into the service station closest to 12 noon would be invited guests to their Christmas celebrations. We spent the next two days there having a wonderful Christmas and making friends for life.



Leo Fowler

Towards the end of my last year at Intermediate school I needed to decide where I would go to High School. I was zoned for Tamaki College and although my father was insistent that I was to go there, I did not want to. The school had a terrible academic record and a reputation for thuggery. I wanted to go to Selwyn College in Kohimaramara, but getting entry was tough. Firstly, I was out-of-zone, secondly my father was not supportive of the idea and thirdly if I had any chance then I had to pass some tough IQ tests and entrance exams. I aced them and was offered a position. My father was never ever happy with that decision.



1968 - My first year at Selwyn - Class 3A

L to R back row: Jonathon Cox, Greg Everard, Tony Bracegirdle, Lindsay Knott, Gregory Wood, Geer Iseke, Ken Farrell, Raymond Joy, Laurie Stanton

L to R 3rd row: Melitza Faine, Eddie Darvil, Mark Jefferson, Alan Bollard, Richard Fletcher, me, Robyn Meltzer

L to R 2nd row: Jackie Collins, Debbie Mason, Nicola Barney, Christine Rudman, Caroline Hawker, Fiona Mouat, Judith Gibson, Christine Miller, Claire Murch

L to R front row: Lorraine Johnstone, Lorraine Bright, Jill Baird, Robyn North, Rosemary Bloomfield, Sally Dutton, Felicity Frazer, Julie Twigge, Lesley Wallace and Miss Rae Storey

In 1968, I started my high school education at Selwyn College. I was placed in a the “A” stream alongside some extremely bright students and my first form teacher was Miss Goodwin (now Mrs Rae Storey). We wore uniforms including a cap (with knob – which I still possess), long socks (with garters) and dark grey shorts. We had 34 in our class.

We were assigned the very best of the teaching staff and given the opportunity to indulge in some advanced education practices. Our first lesson with the science teacher, Mr Chris Smith, was a shock. He pointed to the chart of the periodic table on the wall and said “you all have one night to learn this table in your head ... or you are out of my class!” – we all learned it and yes, I still know it to this day. It is important to note that this same Mr Smith was the man who introduced me to Bridge more than 50 years ago!



Our teachers included Mr Stan Walker for Latin, Miss Evans for French, Mr Skerrett for music, Miss Goodwin & Mr Alan Burton for English, Mr Keith Patience for Social Studies, Mr Smith and Mr Millar for chemistry and physics and Miss Rachel Tucker for maths, Mr Paddy Malone for art, Mr Armstrong for Phys Ed, Mr Green for technical drawing, Miss Gay Griffith for English and the principal was Mr Owen W G Lewis, a hugely respected man and former English master at Auckland Grammar School.

Principal - O. W. G. Lewis



*Miss Rachel Tucker
Mathematics (Introduced
me to computers – I am
forever grateful!)*



*Mr Green - Woodwork
(Taught me Technical
Drawing – wonderful
mentor)*



*Mr Paddy Malone - Tried to
teach me Art*



*Miss Rae Goodwin -
English*



Mr Keith Millar - Physics



Mr Alan Burton - English



*Mr Steven Lowe - Maths
(one of my all-time great
mentors)*



*Mr Geoffrey Skerrett -
Music (fostered my love of
music)*



Mr Stan Walker - Latin



*Miss Evans - French (I
hated the subject!)*



*Mr Keith Patience - Social
Studies*



*Mr Armstrong - Physical
Education*



Form 4A 1969 –

4th row - Richard Fletcher, Jonathan Cox, Anthony Bracegirdle, Geer Iseke, Lindsay Knott, Ken Farrell, Greg Wood, Raymond Joy, Greg Everard. 3rd row – Lorraine Johnstone, Claire Murch, Eddie Darvill, Mark Jefferson, Alan Bollard, Laurie Stanton, Ian Handricks, Christine Miller, Militza Faine. 2nd row – Deborah Mason, Jane McCullough, Fiona Mouat, Lorraine Bright, Janet Boileau, Christine Rudman, Robin Meltzer, Judith Gibson. Front row – Celia Robson, Julie Twigge, Caroline Hawker, Lesley Wallace, Sally Dutton, Pamela Williams, Robyn North, Jill Baird and Mr Keith Millar

More than 50 years later I am still in regular contact with some of my teachers from Selwyn – in particular I see and catch up with Steven Lowe every couple of weeks and Jan and David Butcher every now and then.

I enjoyed my years at Selwyn and certainly the education I received was as good as it gets. Our class stayed together (with one or two minor changes) for the next five years. The school created an innovative programme called “delta” and we were the ones chosen to undertake the new methods of education. It was a pressure-cook regime where we were given significantly more freedoms than others in the school (no uniforms, optional attendance to class etc.) but in return we were expected to learn and study at an accelerated pace learning material designed for students at University.



Jan and David Butcher. Dave taught me physics and Jan (when she was Miss Thrower) taught me English. I appreciate the wisdom they have shown me and I do enjoy the wonderful conversations we have each time we catch up.

SCIENCE MAKES SENSE

book one

HEINEMANN EDUCATIONAL BOOKS LTD
LONDON MELBOURNE AUCKLAND

K.R. Buckley

H.W. Lubeck

C.A. Percy

P.J. Roberts

J.M. Stein

P.A. Tarrant

"Science Make Sense" Textbook written by my Science Teacher, Colin Percy (brother of my future Mechanics Professor, John Percy, at Auckland University) – I was chosen to be the photo on page 36



Fig. 1/16—Complete the sorting of specimens before worrying about their identification.

... why are these insects attracted to sound?
24. Does a community ever s

Homework Project 1-9.

You will have noticed how attracted to outside lights you will not be surprised (scientists who study insects of capturing nocturnal insects in a light trap you could use at home) from a very complicated light trap arrangement, to simply using a board or a sheet of newspaper of the best methods, if you wish to suspend an electric light sheet spread out on the lawn on a warm evening you will be surprised by the number of night flying insects.

Keep these animals and keep a name as many as possible you can then someone in the class can help you. Do these same areas at school? What similarities are there in the area in which you caught them?

Sorting, Counting and Classifying

Collecting animals, either out of doors or by an extraction method such as the Berlese method, is fun and very soon you can identify the animals you have seen and named. All the animals you have captured. All the material. Now is the time to sort and count them.

Experiment 1-10. Using a Berlese funnel to separate animals from the Berlese funnel. Use small beakers or other suitable containers to hold different types of animals and count them.

If all Berlese samples were combined the samples and classified. If all Berlese samples were combined then the results would be different.



My last year at Selwyn



My 1949 Austin A90 a 4 litre 4 cylinder 4-ton monster with no reverse gear, no warrant of fitness, no registration and almost no brakes bedecked with family (Mum standing and me sitting on bonnet, Dad, cousin Sylvia and her Mum, Barbara and Auntie Gwen standing to the side and cousins Donna and Sean and brother Glenn posturing on the roof) Photo taken 1972

Below Me and John Leech posing for photo for music competition





SELWYN COLLEGE

KOHIMARAMA ROAD, AUCKLAND, 5.

REPORT ON Ion Hendricks

DATE April, 1970

FORM 5B1

SUBJECT	COMMENT	Marks %	Class Average	Stream	Effort
I ENGLISH	Ion works well in class - written assignments are sound, oral work is good. He does, however, have some difficulty with basic English grammar.	53	64		B+
II MATHS	Ion's enthusiasm for this subject is backed up by solid work, and he fully deserves first place for this fine result.	93	58	2	A
III Technical Drawing	Ion's great efforts and results are outstanding, particularly considering this is his first year of technical drawing. He well deserves his first place in the whole fifth form group.	71	35		A+
IV Chemistry	Ion shows an interest in the subject - his standard should improve as the year goes on.	50	50	2	B
V Physics	Ion continues to work steadily. He is interested in this subject.	60	55	1	B
VI					
PHYSICAL EDUCATION					B.
EXTRA-CURRICULAR					
SPORT					
GENERAL	Ion is a good student who is to be congratulated on his success in maths and technical drawing.				
HALF-DAYS ABSENT:	A good runner!				
0	Form Teacher: <u>[Signature]</u>		Principal: <u>[Signature]</u>		

The Effort rating (A—E) assesses the work done in assignments and in home preparation, and participation in the classroom.

It was fast and furious, tough and interesting but it did establish in us strong abilities in learning and application of that learning. We were doing nuclear chemistry in the 4th form (year 10 these days), studying calculus in maths and debating great literature in English. We were blessed with the very best of teachers – Mr Steven Lowe for maths, Mr Burton for English and many more. Mr Lowe and Mr Smith were two important influencers in my life and I will forever be grateful for the enthusiasm and energy they put into my education.



Mr Lowe - an influential teacher



My final year at Selwyn in the Delta experimental group

L to R back row: Warren Hawker, Ken Farrell, Paul Hellyer, Lindsey Knott, Tony Bracegirdle

L to R middle row: Me, Morlan Tong, Vaughn Smith, Michael Cole, Alan Bollard, Greg Everard

L to R front row: Bill Toepfer, Sally Dutton, Nicola Barney, Susan Fredericksen, Linda Whitworth, Robyn North, Malcolm Rands and Mr Alan Burton

I was always strong with mathematics and the sciences but always struggled with English and the languages. It is very ironic that I now spend most of my life writing! Maths came easy to me and it helped that I enjoyed solving problems for fun (I still do!). Reading was my Achilles heel – I just did not read books, in fact by the time I reached the 5th form I had not ever read a book from cover to cover, indeed only reading what I absolutely had to, in order to survive the course.



Alan Burton 2022



A small part of my book collection

In my final year at high school I was with a friend in Queen St, Auckland and he dragged me, unwillingly, into a bookstore on the corner of Wellesley and Queen Street. An assistant approached me and asked if he could be of help, at which I bluntly replied, “no!” He persisted and suggested that I might like to read a new book, just published, called “The People’s Almanac” by David Wallechinsky and Irving Wallace. I was sceptical but flicked through it and found myself riveted to various sections reading them with great interest. So, I bought the book. This was an important moment in my life. It ignited my love of reading. I started buying and reading books at an unprecedented rate – 1000’s of them and all of them non-fiction. I discovered that I could learn so much from reading.

I purchased at least seven books a week for the rest of my life. As I travelled around the World I spent all my spare time in bookshops rummaging through the shelves in pursuit of any unusual or interesting tome to read. Blackwell’s Bookshop in Oxford, England became a favourite haunt. Over the years I built a collection of many tens of thousands of books.

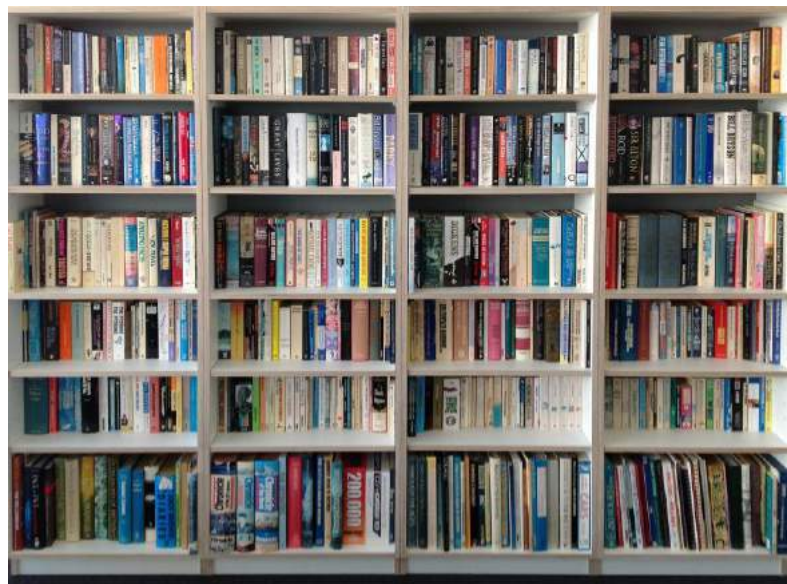



Selwyn College

KOHIMARAMA ROAD
AUCKLAND 5
TELEPHONES 586-009

TESTIMONIAL

14 July 1972

NAME: Ian Lister HANDRICKS FORM: 7ED

DATE OF ENTRY: Feb. 1968 DATE OF LEAVING:

PREVIOUS SECONDARY SCHOOLS ATTENDED: -

<u>PUBLIC EXAMINATIONS PASSED:</u>	School Certificate (4 subjects)	1970
	University Entrance	1971

<u>PRIZES AND CERTIFICATES:</u>	Fourth Form Magazine Prize	1969
	Sixth Form Certificate	1971
	Winner Solo and Duet Guitar in Music Competitions	1970

OFFICES HELD:

SPORTS DISTINCTIONS:

<u>COLLEGE ACTIVITIES:</u>	Music Teacher (Guitar)	1970-72
	Music Groups and Band	1968-72
	Library Assistant	1968-70
	Debating Club	1969
	Chess Club & Radio Club	1968, 9

EXAMINATION ENTRY THIS YEAR:
Universities Bursary

GENERAL:

Ian's record in the College has been a very good one indeed. He has always been punctual and reliable in attendance and careful in personal appearance. He has worked with interest, particularly in Science fields, where he has a considerable background of knowledge and experience, and he has given his assistance and support to a number of College activities where his knowledge has been appreciated. He has been friendly and dependable, a boy of good standards and considerable potential.

O.W.G. Lewis, M.A.,
PRINCIPAL.

My thoughts on education

More often than not, we are taught facts but we often do not get the opportunity to put those facts to work – this can be frustrating and does not help with establishing a good understanding of what was being taught. Things get exciting when we are able to apply the learning to problem solving and applications where that learning could be used to extend his understanding of how things work.

I have always believed that successful education is about having a passion to learn, a desire to explore and the thrill of discovery. Sure, you can teach a child facts, however, it is, I believe, infinitely more exciting and fulfilling if the child can use those facts to discover new concepts, be enlightened by applying logical thinking to problem solving and finding satisfaction in achieving unexpected wisdom.



Me sitting on Makorori Beach in Gisborne 1955 – a goggled idea of the future!

Unfortunately, today's schools have a number of difficulties in being able to deliver the ideal education we all wish for our children. Class sizes of 35 students restricts the dedicated time a teacher can afford an individual pupil – a teacher has around 300 minutes of class time a day meaning that they can only give each pupil 10 minutes of one-on-one attention. Furthermore, with a wide spectrum of abilities in the class, it often means that the faster and more skilful children have to be slowed to stay in touch with those that are struggling. The clear benefit of private tutoring is the dedicated full-time student-teacher time available – the pupil has the undivided attention of the teacher who can monitor and develop the skills of the pupil.

There is no doubt in my mind that there are a number of factors that contribute to the success of a child's education. First and foremost, supportive parents – parents who care, provide opportunity, take an interest and praise the achievements of their child.

I believe that education is best achieved by pivoting around project work. Projects that include a number of key disciplines that address the requirements of the National Curriculum. For example, a project on vexillology (flags) provides the opportunity for the student to study history, geography, graphics and design, political studies and social science and at the same time engaging their writing (English), researching, illustrating (graphics) and presentation (publishing) skills. To give a student the tools to achieve these levels of presentation, they should be taught a logical and structured approach to writing. Too often, I believe, students fail to succeed because they don't have the ability to write in a structured and logical manner.

I also believe that the wisdom, experience and style of successful people in our community can afford magnificent benefits to the new generation. For that reason, I believe that we should always try to provide students with the opportunity to meet and learn from a wide selection of successful pioneers, entrepreneurs and interesting people across a range of disciplines. This can fulfil a yearning to see education in practice. I am one who believes that schools should invite people from within the community to speak regularly to students and that students should have more opportunity to visit successful businesses.

I was blessed with having in my education a number of innovative, exciting, (eccentric!) and special teachers who absolutely and forever changed my life. I believe you are truly lucky if you encounter in your life a role-model who takes an interest in your education, provides a pathway to wisdom and ignites a passion for learning in your soul. A great education is the foundation of an exciting and abundant life.



Learning by experimenting - Here I am having my first attempt at pottery! 1962

Selwyn College's Principal, O. W. G. Lewis said, "Education is about developing enthusiasm. The task of the school and its teachers is to unlock that enthusiasm, to fire the imagination, to show the excitement of learning, to equip young minds to apply knowledge in the pursuit of the goals desired. Hence it follows that a school should be a creative and exciting place, where a diversity of new and stimulating experiences can be found, where students meet other points of view, new understanding, and come to know themselves"

Back to the story ... While I was at Selwyn College I set up my second business venture, teaching guitar and music. I managed to weasel from the headmaster the use of a lockable room behind the stage in the hall and took on dozens of paying students. This was also my first foray into teaching. I kept this venture going for three years until I left for university. It did two things – gave me a steady income and improved my own abilities with music.



Teaching guitar at Selwyn

I was also very fortunate to begin working with computers in 1968 because one of my teachers, Miss Rachel Tucker, had the vision and enthusiasm to begin teaching the subject at a time when there was only a couple of computers in New Zealand. I used a programming language called “PORTTRAN” (Portable FORTRAN) where I created punch cards by poking out perforated holes with a pencil! This experience established in me a passion for technology and was the foundation for my career.

Selwyn was a liberal arts college with an emphasis on academic study rather than sport. The school rarely did well in any sporting venture although we did produce a couple of All Blacks. We were still schooled in the classics back then and were encouraged to take part in the arts – music, theatre and debate. I was actively involved as a laboratory helper in the science labs and took part in the student council. I helped organise the school balls taking on the responsibility for marketing the event by creating crazy posters and wall-art (I used this experience later in my career when I applied the same off-the-wall approach to marketing contact lenses).

I attended my first ball in 1970 with my partner, Kathryn Pilkington, a girl who I had met in 1962 at a camping ground in Orewa, and with whom I am still great friends, now some 59 years later! The balls at Selwyn usually had a theme – Japanese, Country & Western, Roman Empire etc. We all dressed in an immaculate fashion, the girls all went out of their way to look stunning and a great time was had by all.

Inevitably alcohol was banned but always sneaked into the event (sometimes by the teachers!). The pre-ball and post-ball parties were rare and usually pretty small and inconsequential.

I began dating Dorothy Cooke, a wonderful girl from the North Shore. We became very close and she accompanied me to the next ball.

By the time I had reached the start of the 5th form (year 11) I had had enough of French. I hated the subject and saw no practical use of what I was being taught so I decided to drop the subject – this caused no end of anguish for the school in timetabling. Because I was in this “A” stream class it was nearly impossible to re-schedule me into any other subject other than technical drawing, a subject that I had never studied nor considered studying. Despite this, I took it on and crammed learned the two years that I had missed so that I could catch up with the other students who had been learning the techniques for the last two years. Not only did I catch up, but I earned the top marks in the school (and the highest grade for any student in NZ) for the subject and passed School Certificate with an “A”. I simply loved the subject and it gave me the foundation of graphic arts skills that I still use to this day. I am very indebted to Mr Green who had the patience and wisdom to teach me the subject and always gave encouragement to be the best that I can.

About this time, it was decided to make changes to our family home. Extensions were added to the rear and side of the house to upgrade it to a three-bedroom dwelling with a new dining room and a new lounge. The old lounge was converted to a hallway leading to the new lounge and a 3rd bedroom (for my sister) and the kitchen was opened out to create the new dining area. A new deck was created at the back of the house overlooking the back yard. As with many shortcuts my father took in life, he chose to use untreated timber for the deck (it was cheaper to buy) and that soon rotted out making the deck unsafe to use.



The renovations at No. 9 Farrington St

SCHOOL CERTIFICATE

This is to certify that

IAN L HANDRICKS

*has passed the following subject(s) of the
School Certificate Examination*

SUBJECT	GRADE
TECHNICAL DRAWING	A
MATHEMATICS	B
ENGLISH	B
PHYSICS P S S C	C
3 YEARS SECONDARY EDUCATION	
* * * * *	* * * * *
YEAR OF EXAMINATION 1970	
* * * * *	* * * * *

K. J. Sheen

DIRECTOR-GENERAL OF EDUCATION

NEW ZEALAND

SIXTH FORM CERTIFICATE

THIS IS TO CERTIFY THAT

IAN HANDRICKS

has satisfactorily completed at a secondary school an advanced course of instruction in the following subjects and has attained the following grades in these subjects:

Subjects	Grades (A-E)
MATHEMATICS	B
PHYSICS	B
APPLIED MATHS	C*
CHEMISTRY	C*
ENGLISH	C*

Date of issue: November 1971

D. W. Ross

Director-General of Education.

The conditions of award are shown on the back of this certificate

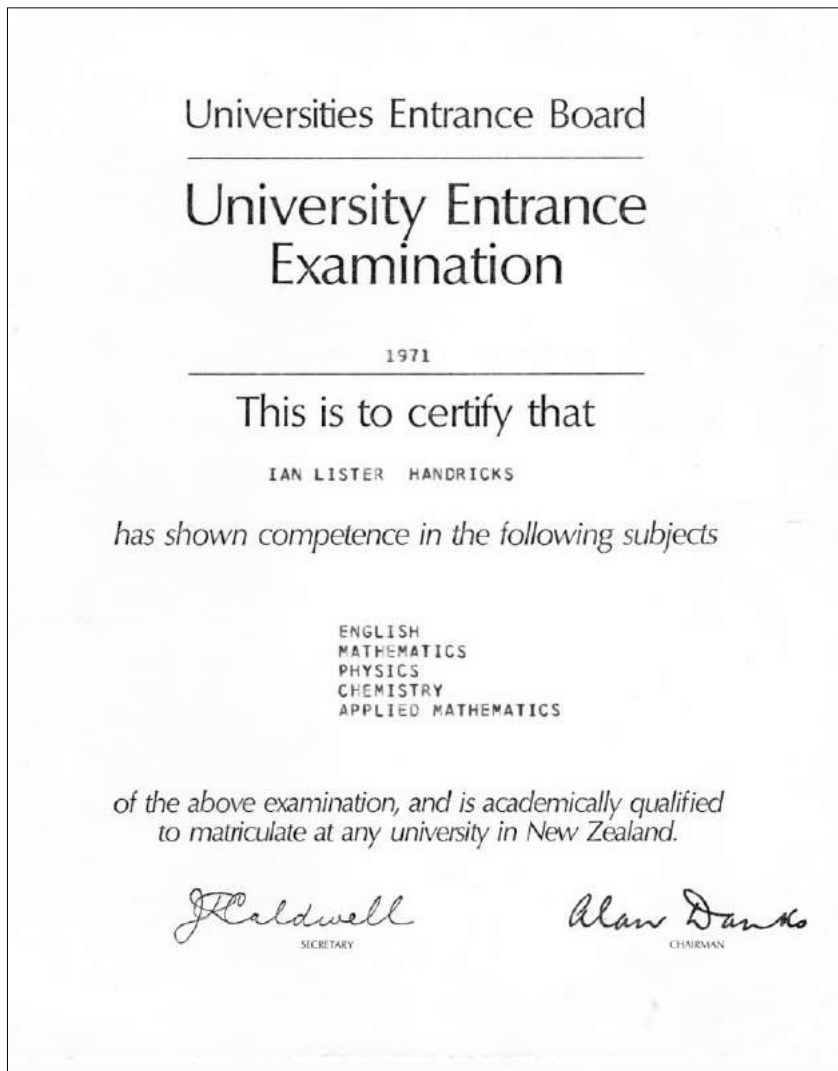

Universities Entrance Board

University Bursaries
Examination

1972

This is to certify that

IAN LISTER HANDRICKS

gained a B award in the above examination.

J Caldwell
SECRETARY

Alan Danks
CHAIRMAN

50941

The choice of colours still continued to be questionable – a bright lime green couch with black specks in the lounge sitting alongside the burnt red hood on the fish tank, khaki floor tiles in the kitchen with yellow Formica bench tops and pastel blue and pink cupboards and the finishing touch weatherboards on the outside of the house painted dark olive green. I was co-opted by my father to help paint the corrugated iron roof and, of course, climb under the house and up into the eaves to hammer in buckle clips for the cabling.

The garden had some new additions; a passionfruit vine running along the boundary, a monster lemon tree in front of the new lounge (it was incredibly prolific) and a lonely rhubarb plant under the deck in solid dry clay (it hardly ever saw the sun and never got watered, but produced rhubarb for decades). I dug, planted and cared for a large vegetable garden in the back yard maintaining a constant war with slugs and white butterflies.

My experiences and education at Selwyn were wonderful. I enjoyed my years there, gained knowledge and friends and it gave me confidence to pursue an exciting career. While there I passed School Certificate with good marks, was accredited University Entrance and sat and was awarded a University Bursary. I also applied for and was granted a Scholarship with New Zealand Electricity Department (NZED) for Auckland University. This Scholarship paid all my University fees and costs and provided me with a guaranteed job during holidays and at the completion of my degree – with one (and major) catch – at a significantly reduced rate of pay decided by the NZED and for as many years that I spent at University. I was in all effect indentured to them for a number of years after my degree. This scholarship was “arranged” by my father to ensure that I entered his trade – I never wanted to be an electrician, I wanted to become either an architect or a cartographer (map maker). Sadly, that opportunity never came my way. I, instead, enrolled as an engineering student studying towards a Bachelor of Engineering (Electrical) degree.

I started University in 1973 choosing mathematics, physics, chemistry, engineering science, mechanics and a compulsory arts subject. This was what was known then as Engineering Intermediate – a kind of prep school for the full-blown Engineering School degree course. I had Prof Hall for chemistry, Prof Percy for mechanics, Prof Hart for maths and others on a rotational basis.



Prof Hart was an aging educator that mumbled at the blackboard and I soon lost interest in his lectures. Prof John Percy was engaging and enthusiastic – in our first lecture with him he arrived into the lecture theatre swinging a string around his head with a large nut tied at the end – he said, “I’m swinging this string about my head – there is a large nut at one end” – he never explained at which end of the string was the nut!

New Zealand Institute of Electricians
Incorporated

Certificate of Studentship

This is to Certify that

San Lister Handricks
of *Auckland* having satisfied the Council
that he is qualified, was on the *15th* day of
February, 1972, enrolled as a **STUDENT**
of the New Zealand Institute of Electricians (Inc.)



CERTIFICATE No. *S499*

Johnston PRESIDENT

Acemovic SECRETARY

NZ INSTITUTE OF ELECTRICIANS

AUCKLAND BRANCH INCORPORATING NORTH SHORE



Telephone: BUSINESS.
PRIVATE. 679-603

Address ALL COMMUNICATIONS-
to THE SECRETARY,
P.O. BOX 1894
AUCKLAND.

16 September 1975

Mr. I. Handricks.

Dear Ian,

Just recently Mr. Mill has asked me to go through my role and get all queries cleared before the end of October. I wrote him your position and what you wanted to do and here is his answer:-

Regarding Ian Handricks he now has to be classified as an Associate, if he wishes to retain membership. I feel that anybody who is interested, as he certainly seemed to be when I heard him at Conference, is to be welcomed, but you will have to get him to sign an application form for Associate. As our year is almost finished, we can make capititation for 1st November at the new rate, and of course he does not pay any entry fee again.

So Ian I am enclosing your form to sign and if you would return it to me with your student badge for you will be issued with a green badge.

Wishing you all the best.

Yours faithfully
Fay Cave

Fay Cave
HON. SECRETARY.

In 1975, I was accepted as an Associate Member of the New Zealand Institute of Electricians – complete with my “green badge!”

I left home in the early 1970's – partly due to my desire for independence and partly due to the fact that home life was miserable with my father dominating the toxic atmosphere in the home with his temper, parsimony, cynicism and ill-will towards us all. I made a sequence of moves – firstly I bunked in with my future brother-in-law at his flat in 8 Browning Street, Grey Lynn (a renovated nineteenth century villa with 12ft stud ceilings). From there I moved to Unit 3, 28 Simpkin Avenue, St John's, Auckland (a brand new 3-unit single-level flat) and then to Unit 1, 12 Strong Street, St John's, Auckland – it was there where I met my future wife, Jocelyn (she was living next door at 10 Strong Street!). Following our marriage, we moved firstly to board with Jocelyn's grandmother, Lydia Brown, at 86 Shakespeare Road, Milford, Auckland (a nineteenth century kauri homestead that had been in the family for generations and a home that occupied half an acre on the west side of Lake Pupuke). After having survived the "guardianship" of the grandmother we really could not wait to get started with our own home – so we built our first at 50 Pemberton Ave, Glenfield. We purchased the site late one dark evening (not knowing what the view was like and having no real idea of how to buy real estate!), More on that later in this book.



8 Browning Street, Grey Lynn



28 Simpkin Ave, St John's



12 Strong St., St John's



50 Pemberton Ave., Glenfield



Gary Cavanaugh

Around the time I started university I met Gary Cavanaugh and his family; parents Betty & Fergus, brothers Peter and Mark and sister Lyn. They lived in a cul-de-sac near my High School and their home soon became a regular Friday night meeting place for our group of friends – me, Gary, Peter, David Wadham, Paul Cullen, John Ravlich, Catherine Lambourg, Jonathan Gee, Eric Balvert, Kerry Maher and a bunch of others. We watched sport together, buried our heads under the bonnets of cars in attempt to keep them running, played a French card game introduced to us by Catherine – Mille Bornes and generally had a great time. Gary had an old black PBX Vauxhall car which we spent some time pushing up Harvey Place so it could be clutch-started on the way back down! This was replaced by his love and joy, a blue VW.

I, along with Gary, also became a member of Auckland East Rotaract which met at the Anglican Church on the corner of Kohimaramara and St Helier's Bay Road. The group was supported by Rotarians John Clendon and Brian Scarborough. Gary and I spent a great deal of time designing wild-goose-chase car rallies for our Rotaract group to run as fund-raisers.

Gary was one of my groomsmen at my wedding and Peter and I still keep in touch some 40 years on. Gary has had a long career in refrigeration and air conditioning and Peter is a recognized authority on banking and finance, financial markets and risk management with 37 years' experience in the New Zealand treasury risk markets.

It was Gary who taught me how to drive – he got me to drive around and around a tiny carpark nestled in the St Helier's Bay shopping precinct late one evening – with that as my complete set of lesson(s), I decided to sit for my licence – it took 7 attempts, but I got it ... and my first parking ticket the same day (I had parked in the Traffic Officer's carpark!)

These were some of the most memorable and enjoyable times of my life. We lived under the bonnets of cars, did some crazy stuff but we steered clear of drugs, excess alcohol and instead had fun doing creative things and supporting each other. Betty and Fergus were wonderful parents and made sure that we all enjoyed our Friday nights together – they were and are a good family.

I got involved in Poker and Bridge while I was at Uni. We played upstairs in the Student Union building. We were also actively involved in capping day pranks.



Peter Cavanaugh

On a sad note, Gary Cavanaugh passed away, after a lengthy battle with cancer, on 11 August 2023. I did have the great fortune of catching up with him earlier in the year and our conversation was full of great memories. His memorial service was held at the Maraetai Beach Boating Club on 25th September 2023 and for the first time in 50 years many of our group of friends were together again.

Gary had been an exceptional and caring husband to Karen and maintained his love of mechanics. When we met, he was proud to show me the Model T Ford that he had fully restored – it was a beautiful testament to his skill and determination.

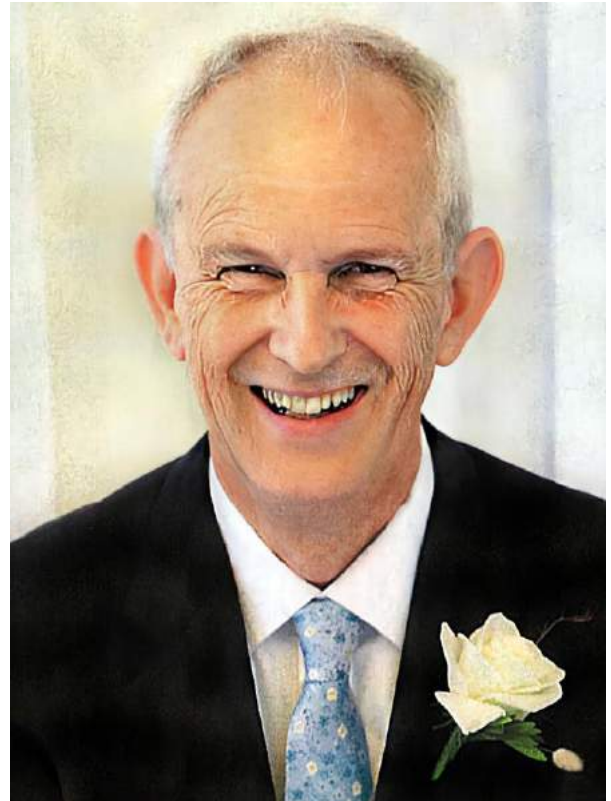

Gary

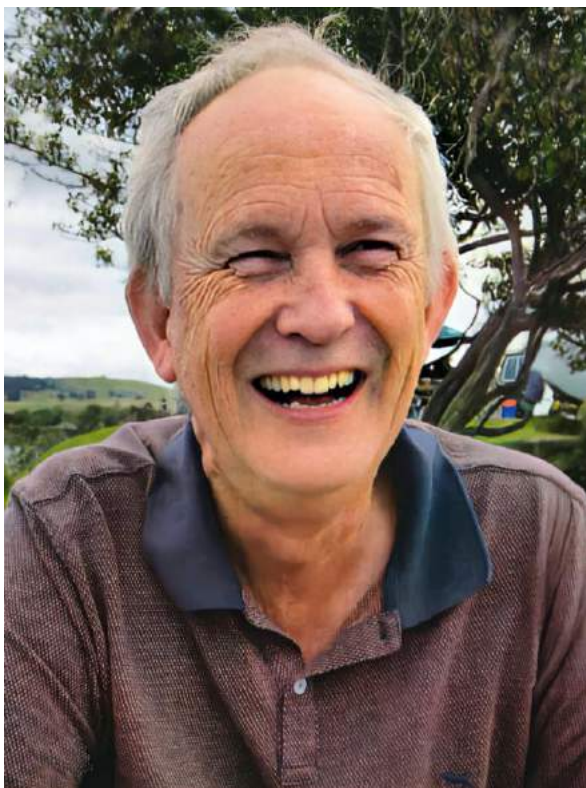

Gary and his restored Model T Ford



My Wedding - (left to right) Ken Bailey, Gary Cavanaugh, Chris Swain, Me, Jocelyn, Nesta Brown, Susan Brown and my sister, Lynette Handricks



Our reunion at Gary's Memorial Service - (left to right) Me, Peter Cavanaugh, Ken Bailey, Eric Balvert, John Ravlich & Chris Swain

One year the new motorway access underpass was being completed at the top of Wellesley Street, adjacent to the Maths and Physics building. There was a small contingent of burly workers completing some work on the road. One group of students headed into the Police saying, “There’s a group of students dressed as workers digging up the new underpass” and at exactly the same time another group of students visited the workers saying, “There’s a group of students dressed like police to tell you to get off the site ... you know what to do”. The real cops met the real workers and we all looked down from the safety of the Maths and Physics building while they slogged it out!

Another time there was the infamous motorbike rally (thousands of students used to take off on their motorbikes in single file and trek around Auckland causing minor mayhem). This particular year they decided to file through, one bike at a time, the toll booths on the Auckland Harbour Bridge (at that time there were still toll booths – bikes were charged 10 cents) – the only problem was they all chose to go through one particular booth and they all presented a \$10 bill and awaited their change!

I was really frustrated and disillusioned with the course that I was taking at Uni, I simply did not want to become an engineer, let alone an electrical engineer. I also was not looking forward to working for years afterwards with NZED at their behest. I was dreadfully unhappy. Home life was awful, university was awful and I was seeking new freedom. So, I bought a \$50 Hillman Minx car (no registration and no warrant) which barely ran, packed all my belongings and left home (for good). With nowhere to go I lived in the car for a while, worked at a local bakery to make some money (and use their showers and kitchen) and basically stopped doing my university work. I desperately needed something to happen – an opportunity to begin again.

The big opportunity that would forever change my life came when one day (23rd September 1974) I was walking down High Street in the city when I notice a small blackboard leaning against the doorway at number 9 High Street, Auckland City. It simply said, “Contact lens polisher wanted – apply level 4”.



At the time I was in bare feet wearing bell-bottomed electric purple jeans and a bright green t-shirt and long, long hair. Despite my appearance, I went up to level 4 and entered the business of Hirst Contact Lens Ltd. I met Mr Stan McKee, the manager, and I applied for the job. In those days it was very difficult to find employees –there were so many jobs available and not enough people to fill the positions. I showed Mr McKee some maths work I had been doing at university and to my surprise he offered me a job with an immediate start. My starting wage was \$80 per month (about 50 cents per hour).



Hirst Contact Lens 1974 at 9 High Street

Hirst Contact Lens Ltd was located at number 9 High Street in Auckland and was the flagship store of Mortimer & Hirst, an eyewear company associated with a rich history of contact lens innovation in New Zealand. The company was the result of a partnership set up between optometrist Douglas Mortimer (1918–2005) and dental technician Eugene Hirst (1911–1989) in 1949, joint directors of both Mortimer & Hirst and Hirst Contact Lens Limited.

In 1939, as refugees from the Nazis, Eugene (Gene) Hirst fled Czechoslovakia with his wife Jana and arrived in New Zealand where he began work as a dental technician. Hirst went on to pioneer the development of contact lens manufacturing in New Zealand.

In the 1940s Hirst became manager of the dental laboratory, Prosthetic Processes Ltd., in Auckland. Because of his skills in dentistry plastics, he was challenged by colleagues in the field to create contact lenses for a near-blind woman with keratoconus. Usually made from glass, Hirst created the first polymethyl methacrylate (perspex) haptic lens, drawing from dental methods to take an impression of the eye to use as the mould.

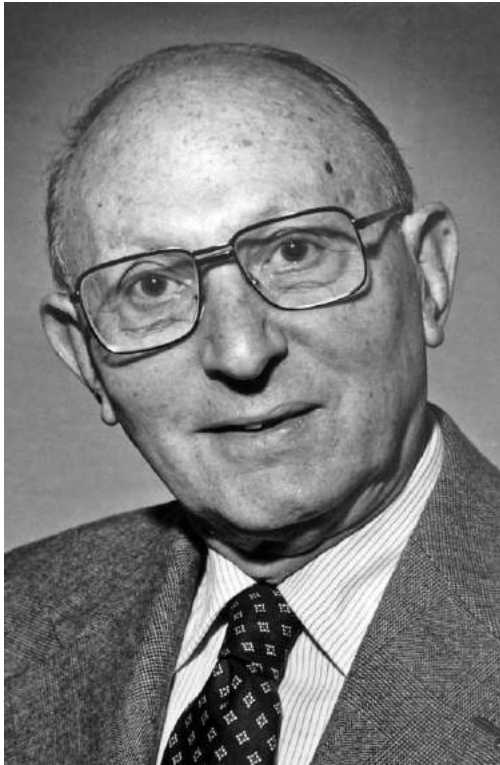

Mr Eugene Hirst

The haptic lens was a 35mm diameter lens fitted over the entire visible eye. They were not in the least bit comfortable for the wearer and it took great perseverance to wear them for an extended period of time. Hirst's innovation was to use a lathe to grind the lens down to mimic the shape of the human eye.

In 1964 Hirst worked with ophthalmologist David Volk to develop a range Con-O-Coid lenses. These lenses were considered a breakthrough in fit because the curvature of the lens was designed to mimic the curves in the anterior surface of the human cornea. Hirst Contact Lens were given exclusive rights to produce these anywhere outside the United States and Canada.

Development of soft contact lenses was also underway. Czech scientist Otto Wichterle had successfully developed material to make the world's first soft contact lens in 1942. Hirst returned to Czechoslovakia in 1966 on business and was able to

obtain the material, HEMA (2-hydroxyethylmethacrylate), and a license from Wichterle to start producing them in New Zealand.

In the early days of the business, Hirst would travel all over New Zealand and work at different optometry practices to take moulds of patients' eyes before returning to Auckland to fabricate the haptic contact lenses.

I could not have been happier. I decided then and there that I would make optics and especially contact lens optics become my career and I had the urge to learn as much as I could about the product and the science and mathematics that supported it. To make matters better, this was a laboratory that thrived on innovation and the owners encouraged participation in development and the science of optics. I may have been motivated to make this move because I wore spectacles and had always wanted to try contact lenses, but they were out of my pocket. Now I might have a chance to try them!

Although the staff was relatively small, each played a part in helping my career. I am indebted to them all for imparting their knowledge and wisdom on me, for providing me with skills and an environment to be successful.



Dr Hirst was born in 1911 in Budapest (Hungary) the youngest of 4 children of Edward Hirschberger and Franciska (Stahler). He moved to Prague (Czechoslovakia) where he was on the staff of the University Dental Clinic as a dental technician. In 1939 he with his wife Jana (nee Tanzer) found safe haven in New Zealand away from the atrocities of the Nazi holocaust in Europe. He was immediately employed by Prosthetic Processes Ltd in Wellington where he remained for a short while before moving to Auckland, where he became manager and later partner of Prosthetic Processes Auckland. He volunteered for service during the war but was manpowered to remain in his essential occupation.

Dr Hirst was clearly both a lateral thinker and an 'early adopter': in 1940 he introduced to New Zealand specialized crown, bridge and porcelain work and the Norwegian system of orthodontics; later in 1958 microbond, crown and bridge work techniques from America. He was honorary instructor in dental prosthetics to the RNZ Navy for over 15 years as well as founder and past President of the NZ Dental Laboratory Association.



Gene Hirst

In 1943, Dr Hirst was approached by an Auckland ophthalmologist who asked him to make what became the first contact lens in New Zealand for a near-blind young woman. The combination of his experience in dental technique and in working

with the clear acrylics developed for dentistry, meant that he was able to visualize how these could be applied to making contact lenses. This gave rise to the setting up of Hirst Contact Lens Limited in Auckland as an optical manufacturer and fitter of contact lenses. In 1950 he joined Mr Mortimer, an Optometrist, and founded the Mortimer and Hirst Optometry practice.

In 1946 the NZ Government Social Security Department accepted contact lens as a medical aid and subsidised their cost, as certain pathological cases could not be helped otherwise. This was particularly helpful at that time to many World War II veterans who had experienced eye conditions following that war. NZ was the first country in the world to introduce this benefit. From the initial experience with contact lenses in 1943, Dr Hirst developed and made available to the people of NZ successive improvements in contact lens technology for nearly 40 years. In 1948 he developed corneal lenses, in 1968 hema and aspheric lenses, quickly followed by the Hirst aspheric toric soft lenses. In 1976 he developed bifocal hema lenses.

Dr Hirst made license agreements with some of the biggest contact lens laboratories in the world, trained their technicians and supplied NZ-made machinery to manufacture aspheric contact lenses. Under various license agreements his contact lenses were manufactured and sold in Japan, England, 14 European countries, 7 Asian countries, South Africa and Canada. He established a contact lens manufacturing laboratory in Adelaide (Australia) in 1970 to produce aspheric contact lenses and later sold this interest to a multinational contact lens manufacturer. He continued as Managing Director of Hirst Contact Lens until its sale to NZ Optical in 1978. He retired as a partner of Mortimer and Hirst Opticians in 1985.

He travelled widely, lecturing and addressing international conferences on contact lenses giving seminars at various universities throughout the world and won for NZ a reputation as a leader of contact lens design and practice. In 1946 he was appointed in an honorary capacity to be in charge of the Auckland Hospital Contact Lens Clinic where he served for 33 years. In 1950 he published in NZ one of the first contact lens journals in the world. Many of his articles were published in international contact lens journals.

In 1980 Dr Hirst was honoured by the International Optometric Honours Fraternity USA and elected as a member of the Beta Sigma Kappa, with an Honorary Doctorate of Ocular Science by the American Optometric Association. This was the first time in 10 years that the honour had been bestowed. He was also awarded the high honour of OBE in 1981 for his services to the Jewish Community and Contact Lens development. The NZ Optical Association at a conference in October 1988 honoured him for the part he had played as Chairman of the Optometric Vision Research Foundation Appeal which raised more than \$400,000 for research in NZ and enabled a Chair of Optics to be established at Auckland University in 1990.



Hirst Contact Lens staff – December 1968

Back row - Will Nyenkamp, Gene Hirst, Sheila Thomas, John Shennan, Mrs Frater, Judy ?, Stan McKee, Margaret Dyason & Doug Mortimer.

Middle row – Mrs Harris & Mrs Marsh.

Front row – Lynn Tucker, Debbie ?, Dorothy Graham, Mrs McCuller, Lynn Brown (nee Taylor) and Bert van der Kolk.



Hirst Contact Lens 1976 – The Toric Crew - Back row: Rob Nyenkamp, Ian Handricks, Warren Powell, Paul Moody. Front row: Jenny Marshall, Philip Langley, Martine Plattman and Shirley Tamihana



Bert van der Kolk accepting the NZ Designmark Award presented to Hirst Contact Lens for the outstanding work we had done on aspheric lenses and peripheral curve design 1977 – note the SEM microscope images of contact lens design on the wall.



Mr & Mrs Doug Mortimer, Mr & Mrs Stan McKee and Mr & Mrs Gene Hirst



*1975 (left to right) Martyn Davy, John Shennan, me, Will Nyenkamp, David Hogsden and Grant Allen - Hirst Contact Lens
7th floor, 9 High St, Auckland (...and, No, I am not drinking the beer!)*



Bert van der Kolk

Bert van der Kolk was the laboratory manager, a Dutchman with many years' of experience in optics. He had a fearsome and somewhat cynical disposition but fostered anyone that showed interest or enthusiasm, but he did not suffer fools. Two incidents stand out - we used small cross sections of rubber tubing to hold the button of plastic that would become the lens and we ran out of tubing one day, so Bert went off to Para Rubber Company to buy some more. He was greeted at the counter by a young lad – Bert asked for 3 feet of rubber tubing, the lad said, “Sir, don't you realise we are in the metric age now?” at which Bert gruffed and said, “Alright, can I have 1.243 metres of tubing”. The lad went out the back and came back saying.” Would you like half inch or quarter inch tubing?” – at which point Bert exploded in a rage of temper!

The second incident involved a young technician we had in the lab who was having difficulty with maths. Bert in a fit of frustration went and purchased a calculator for the technician. Ten minutes later the technician brought the calculator back to Bert saying, “The calculator is not working correctly, it says $12 \times 9 = 108$ and everyone knows that it equals 99” – Bert exploded!

Bert was my first teacher in the lab. He taught me how to use my hands to craft a lens, he taught me the basics of optics and although a hard taskmaster, we maintained a great relationship for many years.

Bert's sidekick was another Dutchman, Jan de Boer, a laconic and peaceful gentleman who had a great understanding of the equipment used in the laboratory. He taught me a lifetime of knowledge on the various lathes, measuring equipment and tools used in optics. Bert and Jan never saw eye-to-eye and were frequently at each other over some trivial matter.



Jan de Boer

John Shennan, more than anyone else, was the greatest teacher anybody could wish for. John is a true gentleman and is respected throughout the optical world for his knowledge, wisdom, kindness and manners. John would one day become my business partner when together we would purchase the company. More of that later. John taught me about precision, taught me techniques to hone my hand skills, introduced me to the optometrists that supported our lab and most importantly, took a big interest in developing and experimenting with design and development of the production and the lenses. I, along with almost everyone else in optics, consider John to be the finest technician the industry has ever known.



Margaret Dyason & John Shennan

Many others there shared their knowledge including Margaret Dyason, Vera Rumens, Ian Storey, Neil Gale and the irascible Mrs Sheila Thomas.

It was a busy time for me – a new job, still working at His Majesty’s Theatre in the evening, at the bakery in the weekends and teaching music in-between – all aimed at getting some money saved. I also moved into my future brother-in-law’s rented house at 8 Browning Street in Grey Lynn. I built my bed from four lengths of 8x1” pine and a square of plastic canvas positioned across and held in place by industrial drawing pins! It was dreadfully uncomfortable. It was not long before I had enough money to get a flat for myself – firstly at 10 Simkin Avenue and then around the corner at 1/12 Strong Street, St Johns.



Astigmatic Lens Collet I designed in 1976 - the collet had two horizontally opposed tangs thicker than the rest and when pressure was applied by rotating the brass sleeve, a toroidal profile was induced into the plastic blank – the posterior curve was then cut into the crimped blank, polished and released to form a surface with two curves at 90° with each other and therefore two focal lengths. The degree to which the brass collet was turned determined the difference in surface geometry.



I designed and patented these bifocal contact lenses in 1992 - they were successful and attracted considerable attention around the world. I was profiled on the front page of the New Zealand Herald and the subject of the television science production – “Beyond 2000”

By now I had upgraded my car to a 1964 EH Holden which was made from 80% rust and 20% paint! The back rear light was permanently bogged in with fibreglass filler and if the bulb ever failed it would require removing the entire body panel! The left side was also crushed in due to the previous owner's accident. To attempt a fix; I drilled a hole through the panel, slung a steel wire through it and attached the other end of the wire to the carport ... and drove at full speed down the drive ... the panel did not move ... the carport collapsed!



My Holden an hour before the carport (behind) was destroyed!

I had a number of flatmates over the time I was at Strong Street culminating in me sharing the flat with Diane, a fellow worker at Hirst Contact Lens. It was an uncomfortable co-existence due to the fact that Diane suffered from acute depression. But we made the most of it.

Not soon after starting the job at Hirst, I decided that I could make a difference to the production efficiency of the lab. At the time, the rectangular lab was laid out with two benches running the length of the room, both facing the rear brick wall. Each of the technicians sat alongside one another but everyone faced the wall. It was also routine for Mr Hirst to make a visit each day, greet us individually and then leave for his office on the 3rd floor. This particular morning, I spoke to Mr Hirst when he arrived at my spot and I said to him, "I think I have a way of doubling the production rate – it will cost you nothing and all I need is access to the lab on Saturday" (I was also aware that most of the managers would be at a conference over that weekend). He looked at me curiously and said, "OK, here's the key",

“If you are successful in doubling production, I’ll promote you to be a supervisor, if you fail you’ll be dismissed!”.



The day after the desks were moved 49 years ago in 1974

I accepted the challenge and that Saturday I made the small change. I simply took one of the long benches and turned it end on end so that it was facing the other bench. I believed that if technicians had something better than a brick wall to look at and better still an opportunity to engage with fellow technicians about issues relating to the production then this would lead to better productivity.

Not only did production double – it increased four-fold. Mr Hirst honoured his promise. I was now a supervisor! For the rest of his life Mr Hirst took a keen interest in my career offering wisdom and advice along with practical knowledge on business. Early in the development of the company, Mr Hirst had virtually no financial reserves, yet he gave away the lenses he produced to optometrists at no charge for the first few months he was in business. They respected him for that and in return he earned their perpetual loyalty. He taught me the great Jewish expression, “Give a little, get a lot” – this offer of free lenses supported that theory. He also taught me that wisdom is the combination of knowledge and experience.

During my early years in the lab I learned all aspects of lens making and lens design. This included lathing, polishing, metrology, peripheral design, producing toric (astigmatic) lenses and much more besides. I learned about materials – the science behind the plastics we used and the physiology of the eye. I studied all aspects of theoretical optics, the mathematics behind the science and all the various visual conditions.

The laboratory has many stories to tell. When we polished a surface it was important to get the radius of the curve accurate. If the radius was larger than we were looking for, we called the result “flat” and conversely, if the radius was smaller than expected, we called the result “steep”. One of crew, Patsy Brennon, who was on the 12-head back surface polishing machine took her duties most seriously to the point of been obsessed. One day she looked up at the clock on the wall and pronounced it to be 5 minutes flat!

Equally obsessed was Bert van der Kolk who kept a notebook of the names of staff who left the company under a shadow or otherwise. The minute they walked out of the door he would take great delight in publicly reaching for his notebook and record their name.



1974 Some of the technicians at Hirst Contact Lens - I'm third from left back row (note the hair!)

*Left to right back row – Jan de Boer, Neil Gale, me, Ian Storey, Warren Powell, ? Charlie Malyon, ? John Shennan, ?
Left to right front row – Margaret Dyason, ? Meree Renham, Carole Mayne, Jenny Marshall*

The High Street building which housed our laboratory was seven stories high with access to the roof on the 8th floor. A couple of our technicians were on the roof one lunch break enjoying a bottle of beer – unfortunately the bottle got dropped from the roof landing on and crushing the bonnet of a car directly in front of our optometry practice. “Mortimer & Hirst” on the ground floor – an infuriated Doug Mortimer ran up eight flights of stairs in under a minute to apprehend the culprits!

We had employees who hid marijuana in the cistern of the ladies’ toilet, another stole the folding iron doors off the elevator to use as front gates for his home and one or two technicians would doze off while working the lenses.

We had a (terrible) elevator-like piped music system in the laboratory. The woman who handled our incoming calls, reception tasks and initiated the jobs to be done, Mrs Sheila Thomas, was a fearsome lady who was easily rankled. She hated the pipe music and would, on arrival each morning, immediately turn the volume down to position “2” (barely audible). One morning, before she arrived, I decided to crank the volume to “12” (deafening!), then remove the knob and replace it at position “2” and then I moved the knob to a low sound position – the inevitable happened – she arrived and promptly cranked the knob to “2” – she never forgave “the horrible rat who rigged the sound system”.

The equipment and tools we used in the lab were a concoction of invention and adaptation. We used self-adhesive Leukoplast as a polishing cloth, pink Silvo for polish, iso-propyl alcohol (dry cleaning fluid) as a cleaner, squares cut from felt hats as an edge polisher, Dr Scholl’s Corn pads as a surface polisher, inverted aluminium jelly moulds to house as a catchment for the spindles in the bench, sharpened pencils as a pivot for brass polished laps, sections of drainage pipe to house bench spindles, lengths of rubber tubing to hold each lens button, razor blades and methylated spirit burners to burn and scrape the surface fluff off the corn pads and melted lead fishing weights to be re-purposed as pivot weights of aspheric polishing machines.

Optometrist vision equipment was adapted to be used as measurement devices – we used a keratometer with a clever inverted glass prism to allow us to measure radii and astigmatic surfaces. Slip gauges to measure diameter, jugged thickness gauges for central thicknesses, adapted loupes (with mires glued on with Canadian Balsam) to measure peripheral curves. Essentially, if your mother wasn’t using it in the kitchen or your father not using it in the garage – we adapted it for use in the laboratory.



Neil Gale standing in front of the Keratometer and a myriad of other adaptations on the workbenches

OPTICAL TECHNICIANS' TRAINING COURSE

STAGE 2

Certificate of Participation

This is to certify that

I. HANDRICKS

has satisfactorily attended a course of instruction in

OPTICAL TECHNOLOGY

Jointly awarded this 26th day of AUGUST 1975
by the New Zealand Optometrical Association, the New Zealand Optical Wholesalers'
Association and the Optical Technicians' and Dispensers' Association of New Zealand.

CHAIRMAN

ORGANISING COMMITTEE



HIRST CONTACT LENS LIMITED

41-45 Leslie Avenue, Mt. Albert, AUCKLAND, P.O. Box 6142 Wellesley Street, AUCKLAND
Phone: 687 049. Telex: 21604. Cables: HONZOAK

22 January 1979

TO WHOM IT MAY CONCERN

This is to verify that Mr Ian L Handricks is employed by Hirst Contact Lens Limited. He commenced his training as a Contact Lens Technician in September 1974. This training was completed in March 1978. Mr Handricks is fully conversant in the theoretical technical and practical knowledge necessary to construct most types of P.M.M.A. and H.E.M.A. contact lenses.

The current position that Mr Handricks holds in the Company is that of a Supervisor in one of our special lens sections. Among his responsibilities is the duty of programming our calculators to process formulae necessary for computing special lens design.

Yours faithfully
HIRST CONTACT LENS LIMITED

J Shennan
Assistant Manager

We manufactured soft contact lenses from a plastic called HEMA (2-hydroxy ethyl methacrylate), a hydrophilic (having a strong affinity for water) material. This material, when it came in contact with water, would expand and the diameter, the thickness grew larger and the curves became flatter (larger radius).

The lenses were cut and polished in the lab when the plastic was in its hard dry (un-hydrated) state. Curves were cut steeper (smaller radius) than the finished lens required and the diameters and thicknesses were cut smaller because they too would expand when the material was hydrated (hard to soft and flexible).

The singular problem for us was the fact water-based polishes could not be used in the manufacturing process because they would induce hydration, so a mixture of olive oil and alum (a fine aluminium powder salt) was created. The polishing mixture had to be remixed each time it was used because the alum would suspend to the bottom of the bottle.

There was an ongoing problem with hydration during manufacture and nobody could put their finger on the source of the problem. I approached Denis Malone from the DSIR and together we ran numerous tests to trace the problem – it turned out to be the olive oil which had significant amounts of H₂O suspended in the mixture. A number of alternatives were tried until we stumbled upon Peach Kernel Oil – it had zero water content. We switched and the problem disappeared – but a new one emerged! At night mice got into the lab and started to eat the polish with the Peach Kernel oil by gnawing through the plastic bottles that contained the polish. They died – rigor mortis by infusion of alum!



1979 - Grant Allan and Brian Bailey (UK office) discussing lens manufacture at our lab in New Zealand

I concentrated on lens design, mathematics of lens design, developing production and marketing methods for the laboratory and eventually computerisation of the design and production of contact lenses. Early on, I built a specially designed slide rule (hand drawn and sellotaped together!) used to calculate the sagittal heights of lenses, the peripheral curve designs and the alignment of tooling required to make them. All of this had previously been worked out using pen and paper and manual mathematics.

In 1975 the first computer store opened in New Zealand, the Computer and Calculator Centre in Lorne Street, Auckland. I was their first customer (having waited at the door for 4 hours until they opened). I was there to purchase a Texas Instruments SR-52 programmable hand-held calculator. It was able to accept 256 lines of program code and I used it to create the world's first contact lens calculator. We used it extensively and it allowed us to make lenses of more intricate designs and make them faster. The programs were stored on 8x1 cm plastic strips which had a magnetic layer on the reverse. After my introduction to programming at school in 1968, this was my next chance to write software.



The TI SR-52

As with many enthusiasts then, I climbed into machine code programming, 8080, hexadecimal and all the other variants being developed at the time. Owning an Apple One was out of the question (too expensive) but I did eventually own a Sinclair ZX80, my first PC. I count myself lucky that I was around at the start of the technology revolution.

One afternoon, around 2:30pm, I was outside trying to fix the Holden (again!) when I was approached by a girl who was living in the next door flat. She said that she had managed to lock herself out of the flat and could I perhaps help her get in? I grabbed my only (maxed out) credit card and managed to release the lock by squeezing the card in the door jamb gap. She was very grateful and offered to make me a coffee (into which she accidentally put salt rather than sugar). Her name was Jocelyn Ruth Brown, and little did I realise it at the time, she would become my wife!

I was still living with Diane at the time and we were due to attend a party that night. I innocently decided to invite Jocelyn to join us. She accepted. By 9:00pm that evening we were virtually inseparable and by midnight I had asked her for her hand in marriage! We celebrated by lying on the cliffs above St Helier's beach at 1:00am in the morning while I recited the full 42-minute version of "Alice's Restaurant" by Arlo Guthrie. As you do!

Jocelyn was the eldest daughter of Owen and Roma Brown, a farming family from Dargaville. She was born in Te Kopuru on 16th December 1954 and she had 5 siblings. Her mother was one of 16 children! Jocelyn was an accomplished Scottish highland dancer and studied to become an office secretary. When I met her she was working in the office for the Consumer Institute, an organisation which produced the “Consumer” magazine.



The day I met Jocelyn (note the famous blue Holden in background between our two flats in Strong Street)

Not soon after we met, Jocelyn moved into my apartment (Diane moved out), and we began planning our wedding. We initially planned to get married on New Year’s Eve 1977 but a week before Christmas I suffered a serious viral infection called encephalitis, an inflammation of the active tissues of the brain caused by an infection or an autoimmune response. The inflammation causes the brain to swell, which can lead to headache, stiff neck, sensitivity to light, mental confusion and seizures. I only knew I had it when I blacked out unconscious while driving down Line Road in Glen Innes (thankfully Jocelyn was with me and was able to stop the car safely).

I ended up in hospital but fully recovered some days later. The event kyboshed our wedding plans and we had to reschedule for 11th February 1978. We were fortunate to have the help of family and friends in planning and making the wedding possible. Jocelyn’s mother organised and made the wedding dress and bridesmaids outfits (another encounter with curious colours – each of the bridesmaids were dressed in red, green and blue respectively), a family friend, Mrs Nola was our photographer, various aunts and cousins baked and cooked for the wedding breakfast, the local Mayor provided us with the Town Hall for the reception, various Uncles ensured we had adequate alcohol – it was a family and friend’s effort!

We were married at the Holy Trinity Anglican Church in Hokianga road, Dargaville in Northland. My best man was Chris Swain and I had two groomsmen – Gary Cavanaugh and Ken Bailey. Jocelyn was attended by her sisters, Nesta and Susan and my sister, Lynette. It was a sunny day and there were around 150 guests.



At the time my car, a Ford Fairmont wagon purchased from my future brother-in-law Lionel, was of questionable reliability (it went occasionally!) and before the wedding my future father-in-law, Owen visited me at the motel where I and my groomsmen were staying and in earshot of them said, "Please take our family car (a pink/purple Holden) on your honeymoon, it's certainly more reliable than what you're driving at the moment!". This offer I gratefully accepted. At the wedding reception I was approached by Nesta, Jocelyn's sister, who secretly passed the keys of her mini to me and said, "use my car not Dad's". When we left the reception we headed at speed towards the pink Holden which had been bedecked with cans, balloons, streamers etc., but we quickly sidestepped and hopped into the Mini and took off at speed leaving the crowd bewildered!



Chris Swain and me in front of my future father-in-law's pink Holden at the Arapohue A & P Show 1978

Prior to the wedding I had confided with Chris, my best man, that Jocelyn and I would be spending the first night of our honeymoon at Kai Iwi Lakes, a few miles north of Dargaville. I said that I was letting him know in case I broke down in an unfamiliar car and needed his assistance. Chris was a trustworthy and reliable friend and I said to him, "keep this plan secret" knowing full well that he would spill the beans!

When we took off in the Mini I headed in the general direction of the Kai Iwi Lakes but at first zig-zagged through the streets of Dargaville to lose the following vehicles. Most of the following vehicles eventually headed to the Lakes in pursuit and hoping to kybosh our first night. When I was clear of them we parked in a back-street near the motel where all the guests were staying, climbed the fence and we spent our first night there in a room I had previously reserved – no one worked out our plan! We began our honeymoon by touring to Cape Reinga and around Northland for the next week.







My fascination with contact lens design and manufacture was gathering momentum. I started looking more closely at how the lenses were being made. The process had been developed over a number of years based loosely on techniques used in the manufacture of false teeth.

The raw material was PMMA (polymethylmethacrylate) which arrived in long rods about 13mm diameter and a metre or so long. These rods were fed into an old lathe which cut them into buttons about 9mm thick and 13mm diameter. These buttons were then placed in the collet of a small lathe that had a swivel stock and genuine diamond tool and a spherical curve was hollowed out in the button.

The hollowed curve was then polished using, of all substances, pink Silvo, a commercial household silver polish. The polished curve was refined and measured on a radiuscope (an instrument that reflected light on the surface and returned the radius of the curve it was observing). When the button was of the right curve, polished and free of scratches, it was mounted curve-side down on a brass holder using hot green dental pitch as a bonding agent. The brass holder and button were spun on a spindle and using our fingers we aligned the button until the button ran true.

Once hardened, the brass holder was mounted on a lathe spindle and the front of the button was cut by diamond with the front (power) curve down to the thickness of the finished lens (about 0.2mm). The brass holder with thin lens attached was then placed back on our bench spindle and we hand polished the surface using small convex brass polishing buttons which matched the radius. These polishing buttons were covered with self-adhesive Leukoplast bandages! We again used Silvo as a polishing agent.



Polishing lenses - note the Leukoplast and bottle of pink Silvo (just to the right of the green-top bottle of iso-propyl alcohol [dry cleaning fluid!]) and the spindles mounted in the bench inside inverted aluminium jelly moulds – we were the masters of adaptation!

Finally, the lens was “popped off” the green pitch that held it for cutting and polishing (usually by placing your thumbnail under an edge and thus releasing the hold). At this point the lens was held using a small green rubber sucker on the convex side and a number of peripheral curves (progressively flatter curves near the edge of the concave side of the lens – the side that will be in contact with the cornea) were ground and polished onto the surface using diamond impregnated concave tools and Leukoplast covered polishing tools.



Polishing a contoured edge on the lens – note the thickness gauge on the shelf and the strips of Leukoplast hanging from the lamp shade!

And the last action was to polish a contoured edge on the lens using various inverted cone tools and polishing devices including strips of stiff plastic covered in Leukoplast, chunks of felt (used in hat-making) impregnated with Silvo and Dr Scholl’s pink-foam bunion pads – again soaked in Silvo. It was indeed a craftsman approach to manufacturing optics highly dependent on the skills of the technician.

We all became adept at feeling imperfections with the tips of our fingers, we could determine by touch the thickness of a lens to fractions of a millimetre and our eyes became expert at identifying flaws, imperfections and distortions in a lens. We learned techniques of identifying astigmatism in a lens by aligning the lens with parallel objects in the distance and we learned to use refraction inside our measuring instruments to refine the accuracy of measurement.

Capping this off was the extensive use of mathematics, especially trigonometry and geometry and the physics of refraction and diffraction of light. I was seriously motivated to develop new methods, improve existing processes and look at new lens designs.



A pantograph which we used to engrave letters and numbers around the edge of a contact lens!



A miniature drill used to fenestrate contact lenses



Home-built contact lens polishing machine

Once I had completed the programming of our design process into the TI calculator and refined the slide rule I began to draw technical diagrams of our lens designs, however the curves were nearly impossible to draw and I needed some help.

In 1975, John Shennan and I visited the DSIR (Department of Science and Industrial Research), a government organisation providing science and engineering help to industry. We met Denis Malone, a highly qualified and newly appointed research engineer with DSIR. Denis would become a life-long friend and we shared a passion for industrial development, innovation and science, Denis introduced us to Dr. David Beech a specialist optical scientist and metrologist (measurement expert) who helped me draw our lens designs. This was the beginning of a 40-year productive and exciting relationship between Hirst Contact Lens and the DSIR.



John Shennan, me and Denis Malone

At the time, our laboratory was one of the only in world manufacturing toric (astigmatic) lenses (lenses which have two separate focal points). They were made by “bending” the plastic using a brass collar and turning gently two small threaded screws along one axis, holding that bend in place while the green pitch hardened and then cutting a spherical surface of the lens, polishing and releasing the lens which reformed itself with two different curves at 90 degrees to each other (a toroidal or toric surface). Because the button was mounted on a solid brass holder, the lens had to be finished before you could determine whether the powers were correct.

The same process could be done on the concave surface of the button by clamping the button in a threaded jig and screwing up two pins at 90 degrees to the clamp (thus “bending” the button) and then cutting the sphere and polishing before releasing to a toroidal shape. Both these processes required a high level of technician skill and was a time-consuming process.

I set about coming up with a simpler and more accurate process. Firstly, I believed it was important that the button should be mounted on a hollow mandrill so that the powers could be measured while in the manufacturing phase and secondly I designed a threaded collet with six tangs, two opposing tangs were thicker, and as the collet was tightened around the lens it induced a toroidal surface. We engaged an engineering company, Winston Davies Ltd. In Glenfield to manufacture the collets. This new process made the lenses easier to produce and more accurate. A success.



Hollow Collet system

Sometime in 1975 I was cutting a lens on the lathe with the green pitch not quite hardened – during the cutting process the lens moved on the mount slightly in a lateral direction. What resulted was a lens with two intersecting offset curves on the anterior surface. When I polished the miss-cut lens I noticed a distinctly bifocal half-moon shape and when I checked the power of the lens I saw two readings! I had inadvertently cut the first bifocal contact lens! This was big news – making a bifocal lens was the Nirvana of the lens industry – more than 50% of visual correction is achieved through the use of bifocal lenses.

I decided to patent the design. Using Mr Doug Graham (yes, the future Minister for Maori land settlements) I set about patenting the design (at great expense). When Mr Hirst learned of what I had done, he was furious and said that because I had developed the lens as part of my employment, that the patent belonged to the company.

I learned a big lesson, however we all came to a settlement. My name is on the patent, Hirst Lens had exclusive use of the patent at no cost to them. I had the honour of having my first patent, they had the financial benefit. This bifocal lens would be developed globally – more of this later in the story.

In 1976 the laboratory moved from High Street in the city to Leslie Avenue, Morningside, Auckland into a very large especially designed building housing New Zealand Optical company (NZO), Hirst Contact Lens Ltd and Shadze Sunglasses. We remained a separate company for a while but soon became part of the NZO group, a partially autonomous entity within the NZO structure. The new lab was a long “L” shaped facility with some shared office space in the administration part of the building.



Moving into Leslie Ave Laboratory

The NZO group was run by Michael Dent, the managing Director and he in turn represented the interests of Polarizers a family (The Ashby family) holding company which were the majority shareholders. Howard Ross was head of marketing with special emphasis on Shadze.

The contact lens lab grew quickly and at one stage we had 88 staff arranged in production units, each specializing in a particular set of lens designs or lens processes. I was initially part of the toric team but was active throughout the lab.

NEW ZEALAND
PATENTS ACT 1953
PROVISIONAL SPECIFICATION
"IMPROVEMENTS IN AND RELATING TO METHOD OF MANUFACTURE
OF LENSES"

I IAN LISTER HANDRICKS of 12 Strong Street, St. Johns,
Auckland, New Zealand, a British subject and New Zealand
citizen, do hereby declare the invention to be described
in the following statement :-

- 1 -

The patent for my bifocal contact lens

This invention relates to methods of manufacturing contact lenses and more particularly to the manufacture of bi or multi focal contact lenses.

In the past, contact lenses have normally been uni-focal and of a focal length suitable for "distance" vision as it is difficult for a person to wear contact lenses suitable for "near" vision in normal use. For some persons, especially older persons, uni-focal contact lenses create difficulties as when such a person wishes to read and the like and needs also modified "near" vision for such reading or close work, it is necessary for such a person to wear a set of spectacles as well as the contact lenses so as to modify his vision to suit.

More recently, bi or multi-focal contact lenses have been manufactured, such lenses being formed of a specialized "blank" having certain areas within the blank formed of materials having differing refractive qualities fused with one another so that some parts of the blank have a higher or lower refractive power than other areas. The lens is manufactured by positioning the blank in such a manner and forming the lens so that the differing refractive areas are situated in the correct place in the manufactured lens so as to provide required powers to suit "distance" and "near" vision.

It will be appreciated that the manufacture of such a contact lens is an extremely technical and skilled operation and, even with such technical and skilled operators, often many unsuitable lenses are produced in the process of making a set to the correct specifications therefore, such contact lenses tend to be extremely expensive, notwithstanding the expense of manufacturing the blank with the fused portions of differing refractivity as required.

- 2 -

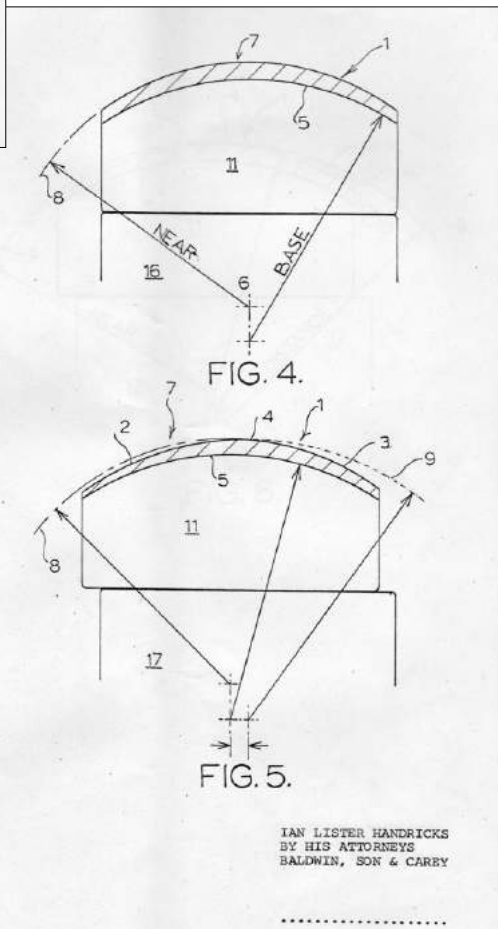
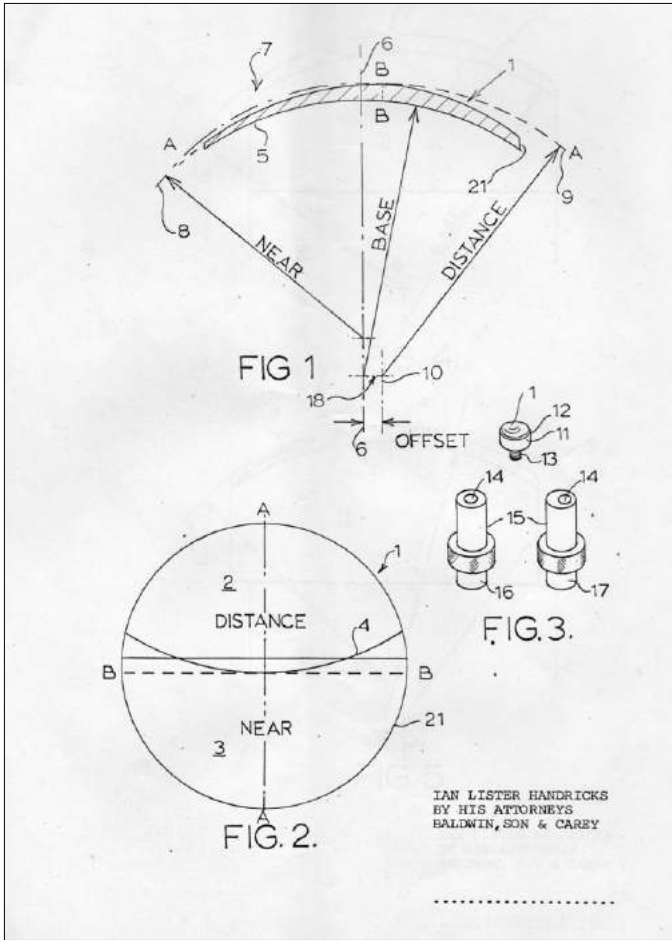

April 17, 1979

Mr. Ian Handricks,
50 Pemberton Ave, Glenfield,
Auckland 10, New Zealand.

Dear Ian:

Thank you for your letter. Once again, I would like to apologize for not replying to your letter of March 8th until now. As I explained to you, I have been away and also have had a number of visitors to my lab.

First, let me say that I am most encouraged by your interest in immigrating to Canada and as I mentioned on the phone, I would be most interested in obtaining your services, and I am prepared to offer you the following proposal should you decide to join our firm.

Corneal Contact Lens Company is a young company formed in June, 1974. We operate primarily out of Calgary, Alberta, a western province rich in oil and agriculture. Our lab is going very well here. In January of 1978, we opened a distribution center in a city 800 miles east, in Winnipeg, Manitoba. We operated under this system until October of 1978 when at that time, we established a small lab for manufacturing hard and soft contact lenses. It has operated on that basis since that time, however, is in need of manufacturing talent as well as working with specialty lenses.

If you are willing to come to Canada and take over the Winnipeg operation, I believe it has the potential to become one of the finest labs we have in Canada. Although we are doing little research in that lab at the moment, we will give you a free hand and will certainly have you involved in all of our programs that are going on in Calgary.

We would offer you a starting wage of \$12,500.00 per annum as well as a commission of 1% on each month's sales. This would give you an annual income of approximately \$14,000.00, plus annual cost of living adjustments.

After a two year period, we will negotiate your further position. For example, we feel the long range company policy will be to include key personnel in an equity position.

As I mentioned to you, we would like you to consider the possibility of coming to Canada by the middle of August, so that we could have you take over the branch by September. Of course, as we agreed, we would cover your immigration costs, transportation, etc., and assist you getting settled in this country.

It is important that you apply to Immigration in your country. We have already set the wheels in motion here and I will keep you informed of our progress.

Yours sincerely,



William L. Sturm.

My first opportunity to emigrate and work in Canada – Job offer from Bill Sturm of Corneal Contact Lens Company of Calgary – I was 23 years old and only married for 2 years

Early in 1977 we had a visit from Bill Sturm, the owner of a large lens lab in Calgary, Canada. I was introduced to him and soon after he offered me a position in his laboratory. I would need to emigrate to Calgary and the offer seemed exciting. I consulted many people about what I should do, however, in the end I decided to stay put. At the time I think I regretted the decision but something more exciting was about to happen!

After we were married, we moved into 81 Shakespeare Road, Milford with Jocelyn's aging grandmother, Lydia Brown. The large property (2 acres) backed onto Lake Pupuke and the house was a large kauri home built in the 19th century. The family had occupied the property since the first Europeans settled in the area. Lydia's grandfather, Alexander McKay, opened the first store in what would become High Street in the city and later he became a farmer on the North Shore owning all the land from Shakespeare Road to the top of Glenfield Road and including where the current Takapuna Golf Course is situated. The home we now occupied was the original farmhouse.



Our first home after we were married – the original home of Alexander Mackay, 81 Shakespeare Road, Takapuna

I spent my time there clearing the huge bamboo growth beside the lake (a very difficult and frustrating task). We soon wanted to establish a home of our own (living with an aging grandmother was difficult). So one evening we went for a drive to see what we might see. We ended up in Pemberton Avenue, in a new subdivision at the end of Manuka Rd, Glenfield. It was pitch black and we had no idea what was in the area, but the next morning I approached the Real Estate company and placed a small deposit on No. 50 Pemberton Avenue. Then went and had a look in the daytime. As it turned out we were on a hill with a great view of Heliyer's Creek and it looked pretty good.

We had no money, no idea about mortgages, no idea about building a house – we were naïve and green when it came to property ownership.

My lawyer at the time was Doug Graham's partner, Mr Michael Mathieson, a wonderful guy with a good heart and pragmatic approach to finding a solution.



No. 50 Pemberton Avenue



I spent weeks (day and night) up to my knees in mud during the construction



To save money I dug the drains (by hand!)



The plastering complete!



My friends turned up to help me lay the drive - we mixed it all by hand (I also built the letterbox!)



Jocelyn was learning to drive - I purchased this 1 1/2 ton Morris side-valve car for her for \$55 - all we could afford

He helped us piece together two mortgages from two different banks with nothing to spare, we purchased the property. Bear in mind, at that time it was extremely difficult to get one mortgage and virtually impossible to get two! We decided to use the “Waverley” design from Universal Homes, a cottage-like 3-bedroom home with mock shutters on the windows, finials on the eaves and a small deck at the front door.

During the building process I spent a great deal of time on the property doing ground work and dealing with drainage and the dreadful soil quality – in fact there was no topsoil (it had all been removed by the developers), it was solid rock-hard clay.

I also decided to teach Jocelyn how to drive (she didn’t have a licence nor did she have any idea how to move a vehicle!). I purchased an old Morris car (a one and half ton beast with manual gear change) for her to learn in. It was a frustrating experience with many interesting incidents on the journey. At one time we were visiting a friend down a long steep driveway – Jocelyn panicked and slammed on the brakes and wrenched the handbrake upwards with so much force it bent the brake handle! She did eventually get her licence and we got rid of the car!

We moved into our new home and a few months later we were expecting our first child. Our son, and only grandson, Daniel Logan Handricks was born at National Women’s Hospital, Auckland on 20th May 1981, on his due date and at exactly 7 pounds in weight. His name was derived from photos in two newspapers Jocelyn and I were reading in a café (run by a Mr Poklington) in Customs Street one morning before he was born – on my paper there was a Mr Daniel and on hers there was a Mr Logan. Problem solved, our new child would be called Daniel Logan!



Daniel Logan Handricks with Dad and Mum

Daniel was a noisy baby. He could scream blue murder and he was always active. However, a clever piece of advice came from a friend, Peter Cavanaugh, who was visiting at the time – he suggested blowing gently in the face of a screaming child and in no time they will quieten down – it worked like a charm. A technique I have used ever since.



My cat "Black cat"



"Black Cat" loved Vegemite - he would roll the jar around the room with his tongue pushed in to the opening eventually ending up with a dark black ring around his face!



My mum taught me to sew



Daniel and me on the front steps of our new home



Our engagement photo



Daniel with his grandparents - Norma and Eddie Handricks and Roma and Owen Brown

About the time Daniel was born I inadvertently interrupted a meeting of senior management at work, I excused myself but was asked to join the meeting. The company had decided to establish a major new operation in England from where it would launch the design and manufacture of contact lenses and a range of new computer-controlled lathing systems. It was felt by the company that I should be in England to take a major role in the establishment, development and running of the new facility because I had both computer and lens knowledge and had shown initiative over the years. I was formally invited to emigrate to England and take up the new role.

This was a big decision and considering we had only just moved into our first home and only just had our first child, this was an even bigger decision for Jocelyn, one she didn't enjoy making. I was very keen and saw this as a chance to really make it in business and one, this time, that I should not decline. I hasten to add we were both working multiple jobs to make ends meet – I was still working in theatre, teaching music and working in lenses and Jocelyn was at her day job with Consumers Institute and making sandwiches for a café early in the morning and we were balancing that caring for a new born son. We were both pretty weary with the load so we made the decision to emigrate!

I made two round trips in quick succession to England and back via the United States to suss out the opportunity. This was the first time that I'd ever been on an aeroplane. I was knocked back by just how big the 747 jet was and the sheer number of people on board. I was not prepared for the 25 plus hours of flying but was very excited at seeing another country.

The first stop was Los Angeles, then one big hop to London, Heathrow. I was met by Andrew Stewart, the company's accountant in the UK who drove me to High Wycombe, the Buckinghamshire home of the company. Our facility was a large building in Lincoln Road on the Cressex Industrial Estate at the top of the Wycombe Hill road and adjacent to the M40 motorway interchange. I lodged at the Crest Hotel situated on that interchange.

Back home we packed up and put all of our possessions in 17 tea chests, everything we owned was securely sealed in those tea chests and we decided not to sell the house, but make it available as a rental. As it turned out, a well-known New Zealand comedian/entertainer, famous for impersonating our Prime Minister, Robert Muldoon, became our tenant (he ended up being evicted because he almost trashed the place!). We left New Zealand in May 1982 and headed to the UK via Boston, USA. We stopped for a while in Keene, New Hampshire where a colleague of mine, Walt Lewandowski and his wife Pat lived. They actually lived in a small and remote township to the East called Spofford in a genuine log cabin way up in the woods. Daniel celebrated his first birthday there.



Pat and Walt Lewandowski with two of their daughters



Walt and Patty's log cabin house in Spofford, New Hampshire where Daniel celebrated his 1st birthday



Walt's rusty Chevrolet which sits at the top of his long driveway through the bush that is used to winch cars up the drive in the middle of winter when the snow is too deep to allow driving up the drive as an option



This Certificate issued in Commemoration of an Historical Event, namely in that the Traveller of the Air, whose name is entered below

IAN HANDRICKS

Has Crossed
The Equatorial Line

IN the self-same spirit of Discovery that led to the voyages of Captain James Cook and his subsequent crossings of the Line in the course of his Pacific Explorations

Dated this day 25 JULY in the year 1981

In flight between LOS ANGELES and AUCKLAND

**Captain James Cook;
Pacific Navigator**

On Friday August 25th 1768, Captain James Cook, with a complement of 94 men, sailed from England in the barque 'Endeavour' to observe the transit of Venus. This and his later voyages took him to Tahiti, New Zealand, the Cook Islands, the Antarctic, Easter Island, the Marquesas, the New Hebrides, New Caledonia, Norfolk Island and Hawaii, where he died. The South Pacific voyages of discovery over 200 years ago paved the way for daily crossings of the equator and the international dateline by the specially designed fleet of Air New Zealand, which capture the friendly spirit of the very islands you will discover for yourself, or will see from the comfort of your aircraft.

AIR NEW ZEALAND

CM.5T-KP2008 Air New Zealand Print



This Certificate issued in Commemoration of an Historical Event, namely in that the Traveller of the Air, whose name is entered below

IAN HANDRICKS

Has Crossed
The Dateline

IN the self-same spirit of Discovery that led to the voyages of Captain James Cook and his subsequent crossings of the Line in the course of his Pacific Explorations

Dated this day 25 JULY in the year 1981

In flight between LOS ANGELES and AUCKLAND

**Captain James Cook;
Pacific Navigator**

On Friday August 25th 1768, Captain James Cook, with a complement of 94 men, sailed from England in the barque 'Endeavour' to observe the transit of Venus. This and his later voyages took him to Tahiti, New Zealand, the Cook Islands, the Antarctic, Easter Island, the Marquesas, the New Hebrides, New Caledonia, Norfolk Island and Hawaii, where he died. The South Pacific voyages of discovery over 200 years ago paved the way for daily crossings of the equator and the international dateline by the specially designed fleet of Air New Zealand, which capture the friendly spirit of the very islands you will discover for yourself, or will see from the comfort of your aircraft.

AIR NEW ZEALAND

CM.5T-KP2008 Air New Zealand Print

We landed in England in a bitterly cold and wet winter's day. It was miserable and overcast, Daniel was screaming and Jocelyn was in tears and not one bit happy that she was going to be living in this uninviting place! We were picked up in the company van and taken to our first home in the UK, a rented 3-bedroom bungalow called "Jesselton" at the end of Downley Road, Naphill - a community near High Wycombe.



Jocelyn, Daniel and me inside "Jesselton", Downley Road, Naphill

It was a nice home, but cold. A few days later our possessions arrived ... well, what was left of them ... 1 broken tea chest with only a few items left inside. All 17 tea chests had been broken into on Auckland wharves and everything was stolen. We had nothing left. All of our possessions were gone. This was almost the last straw for Jocelyn.

I arranged payment of insurance on everything and with that money, we had enough to place a deposit on a house in England. Setting up a bank facility and arranging a mortgage was much more difficult. It took the guile of Andrew Stewart, our company accountant, and many meetings with bank managers to finally allow us to set up an account and arrange a mortgage.

We found a home to buy in a small quaint village, called Chalgrove, nestled in the Chiltern Hundreds, a few miles south of Oxford on the Cowley Road. The house at No. 1 Willow Mead was delightful, on the small side, a bungalow with three bedrooms and lovely garden.

Just prior to moving into our house in Chalgrove, me, Jocelyn and baby Daniel stayed in the rooms upstairs at the Bull at Bisham Inn near Marlow in Buckinghamshire. Our rooms were in the upper storey of the pub shown in the photo below (the stud height was only 5ft – I had to crouch everywhere to avoid hitting my head!).





I Willow Mead, Chalgrove, Oxfordshire, England (Jocelyn with Daniel and Helen)

We both fell in love with it immediately. We completed the purchase and moved in – little did we know that at the same time, Howard Ross, another New Zealand manager who had come over for the new venture, had also selected and purchased a home in the same remote village!

The company developed rapidly in England. Mike Dent came over as the Managing Director, his secretary was a lady by the name of Jo North. We had part of the premises set aside to manufacture spectacle frames (the main factory was in a windmill at Whitstable in Kent) run by Dennis Brown, another section as a contact lens lab, managed by Brian Bailey and the rest of the factory set aside as an engineering and computer programming area where we would eventually develop a significant range of CNC (Computer Numerically Controlled) contact lens lathes and state-of-the-art manufacturing equipment.

I was appointed to head the programming and design teams and was made the International Sales Manager. A very talented engineer, Roy Dorey (whose brother, Ray, was in the rock group “Edison Lighthouse” with their big hit “Love Grows where Rosemary Goes”) headed the engineering team in the workshop and we set about hiring a team of clever engineers and computer programmers.



“Jesselton” at the end of Downley Road, Naphill



OHL - Lincoln Road, Cressex Industrial Estate, High Wycombe

Our company in the UK, Optical Holdings Ltd. (OHL) occupied a very large building at the end of Lincoln Road on the Cressex Industrial Estate at the top of the Wycombe Road, High Wycombe, Buckinghamshire. The operation of the company was split into five divisions: spectacle manufacture, contact lens laboratory, polarising filters, engineering and programming supported by a centralised administration, accounting, sales and marketing hub.

I was initially given the task of establishing the contact lens lab, building the laboratory and training the team. Brian Bailey was appointed the Contact Lens Lab manager and his core team were Rene Sears (supervisor), Jean Manze, Wendy Richards and Richard Bragginton. The spectacle team was managed by Brian Griffin and supervised by Dennis Brown. Bill Guidery provided workshop support and Mick Robinson looked after the warehouse and logistics.

The Polytech Engineering team was managed by Roy Dorey and he was supported by Peter Lancaster, Kevin, Brian and a number of other specialist engineers. I managed the programming team which included David Ranson, Colin Wilson, Michael Chilton, John Snellgrove and others. Polarizers, the filters division, was run by Brian (Mac) McKenny and supported in sales by Richard Lane in the UK and Wim Anema in Europe.

Andrew Stewart was our accountant, Val Stevens was Mike Dent's PA, Jo North, took care of direct sales with me and Howard Ross looking after international and national sales respectively. Jeanie Calhoun was contracted to gain us our FDA certification. Mike Dent was the CEO and later we employed Trevor Holmes as General Manager. Duncan Ashby, representing the shareholders, worked with me in developing the first practice management software package and later he established a very large optometry practice in Reading, Berkshire. Jack Davies (JC) ran our operation in Calgary, Alberta, Canada and Briant Benson looked after our operation in Sacramento, USA. Susan McKeever was our Advertising and Publicity Manager.

The idea was that we would develop a range of computer controlled and programmable machines that could replicate the hand skills of a contact lens technician.



Trevor Holmes (General Manager)



Our home in Oxfordshire - 1 Willow Mead, Chalgrove



One of the nine local pubs in and around Chalgrove - "The Red Lion" - The place where we would eventually name our new business - "Photopages"

Chalgrove, our home for most of the time we lived in England, is a picturesque village located in South Oxfordshire and is a quintessential example of English rural charm and historical depth. Nestled within the rolling hills and lush greenery of the Oxfordshire countryside, Chalgrove is a settlement steeped in history, dating back to the medieval era and beyond.

The village's historical roots are deep and multifaceted. It is mentioned in the Domesday Book of 1086. The area around Chalgrove was known for its agricultural productivity. Chalgrove is most famous for its connection to the English Civil War. The Battle of Chalgrove Field, fought in 1643, was a significant skirmish between Royalist and Parliamentary forces. This event is commemorated by a monument near the site.

The village is home to St. Mary's Church, very close to our home, a beautiful and historically significant building. This church, predominantly dating from the 14th and 15th centuries, is renowned for its medieval wall paintings, which are among the most complete and interesting in the country. Chalgrove also has a collection of charming thatched cottages and traditional brick houses, many of which date back several centuries. These buildings, with their well-preserved architecture, contribute to the village's timeless atmosphere and are a draw for both residents and visitors who are looking for a taste of traditional English country life.

The village today is a vibrant community with a mix of old and new. It has pubs, a primary school, shops, and a post office. Community life in Chalgrove is active and inclusive and annual events, like the antique bicycle tour and the Chalgrove Festival bring the community together and attracts visitors.



The Chalgrove antique bicycle tour

In recent years, Chalgrove has also been recognized for its contribution to the aerospace industry. The village is home to a significant research and development site, which focuses on the innovation of aircraft ejection seats and related technologies.

We made many friends in and around the village including Ralf & Joan Eller, Trish & Gordon Fryer, Jane Fleming and many more. Daniel's first school was the village Primary School and Jocelyn took an active part in the local playgroup. The village had a large barn where social events took place, a water mill where grain was turned to flour, a manor house and many pubs – places we frequented often and where we enjoyed playing darts, dominos and a local pub game called Aunt Sally. English pub meals are excellent and we were very much spoiled by having a number of world-class restaurants within easy reach of our village – The Lord Nelson in Brightwell Baldwin, The Red Lion in Chalgrove, The Chequers Inn in Berrick Salome, The Half Moon in Cuxham, Shillingford Bridge at Benson and many others.



"Aunt Sally" is a traditional English pub game, primarily played in Oxfordshire. It involves skill, dexterity, and precision, where players throw sticks at a wooden target ("dolly") placed on a metal spike, aiming to dislodge it without hitting the spike. Played outdoors, often in pub gardens or at community events, the game is set about 30 feet from the target. Scoring depends on successfully knocking off the dolly without striking the spike.



High Street, Chalgrove



War Memorial, Chalgrove



Spectacle making in the UK office



Part of the new contact lens laboratory in the UK



Me in the foreground with the first IBM PC (1981) and my programming and design team (note the WREN luggable computer to my left)



The engineering workshop we built to manufacture the CNC equipment



Above: The contact lens laboratory technicians in the UK and me (1981) L to R Brian Bailey, Jean Manze, Wendy Richards, me, Rene Sears and Richard Bragginton

below: Roy Dorey working on our first robot

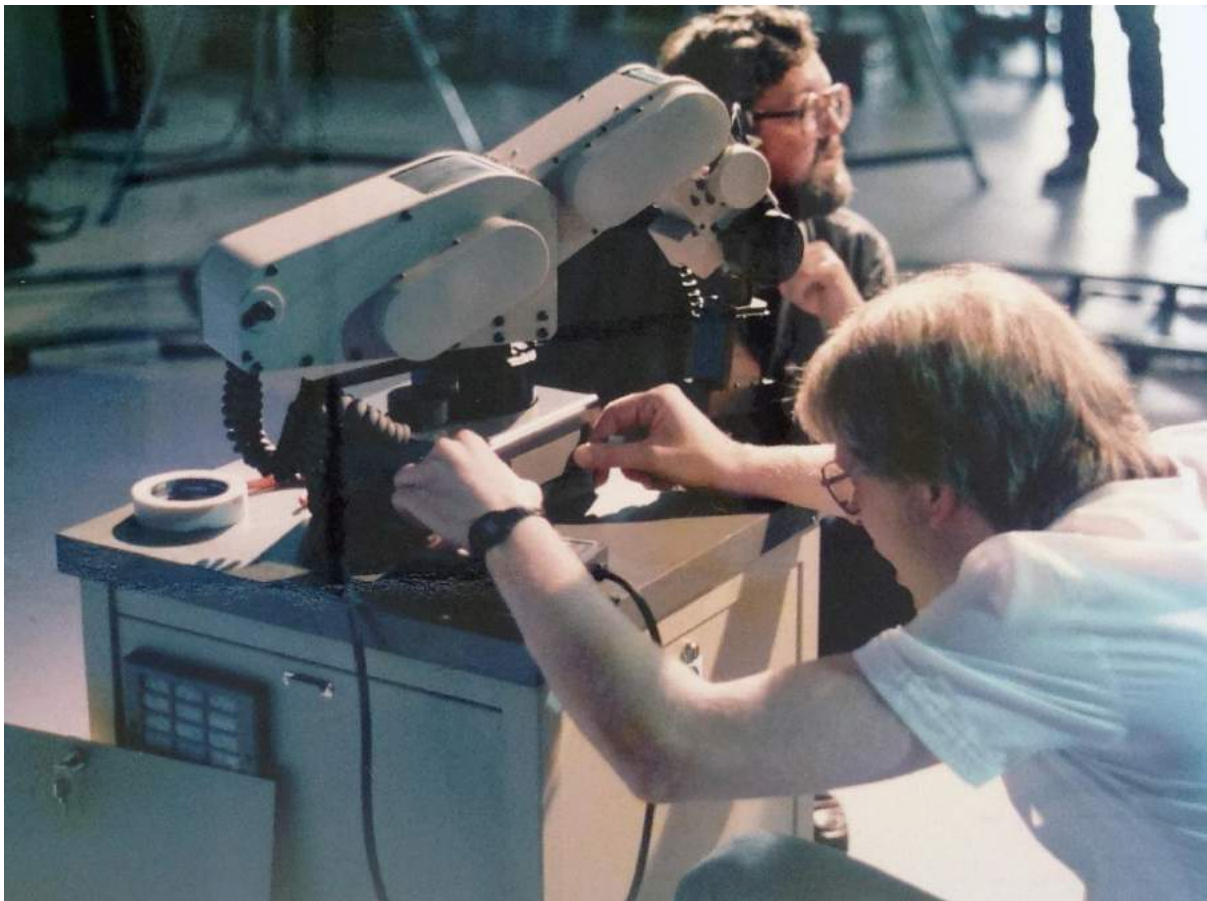



Some of the people I worked with in the Contact Lens years – left to right – David Gourlie, Graeme McRea, Jenny Marshall, Jo North, Gordon Stevenson, Jeannie Calhoun, Karen, Peter Lancaster, Maree Renham, Bill Guidrey, Mick Robinson, J.C. Davies, John Manning, Briant Benson, John Shennan, Marion Evans, Alistair Neave, Pam McPhee, Rene Sears, Lex Grocott, Roy Dorey, Brian Bayley, Charles Allen, Susan McKeever and Jean Manze



Some more of the people I worked with in the Contact Lens years – left to right – Phillip Langley, Alan Bott, Sharon Green, Alan Jennins, Shirley Tamihana, Stan McKee, Laurence O’Connell, Bert Van der Kolk, Charlie Malyon, Doug Mortimer, Phil Camish, Dennis ?, Denis Malone, Grant Allen, Neil Gale, Vera Rumens, Ian Storey, Julian Roscoe, Noel Templeton, Howard Ross, Brian Gifford, Will Nyenkamp, Carole Mayne, Mike Dent and Paul Rose

I studied and recorded every hand, arm and finger movement made by technicians making the lenses. I also coded all the lathe movements, measurement logistics and process steps until I had a way of writing computer code that could mimic all of these actions. This had never been attempted before and we were breaking new ground. It was even more complicated by the fact that the IBM PC had not yet been released and we were forced to use archaic S-100, CP/M computers for the control system and a newly devised programming language, Pascal, which was not easily adapted to control machinery.

Add to these difficulties the fact that we were having to engineer machine accuracy in microns ($\frac{1}{1000}$ of a millimetre) with only recently developed and rudimentary servo and stepper control systems available to us. We needed to find a company that could fabricate a compressed air spindle (a rotating shaft spinning in air rather than ball-bearings) that could run at least 10,000 RPM – this was space-race technology.

We found the suitable supplier in Keene New Hampshire – Pneumo Precision Corporation. The company was headed by Mr Don Brehm and we were offered the talents of their senior engineer, Walt Lewandowski (yes, the same guy with whom our Daniel spent his first birthday). Walt and I have remained close friends for more than forty years and have never lost contact with each other.



We built a full-size wooden model of the lathe before engineering the first model

I moved to Keene for some months and worked alongside Walt at a remote building on the highway near Spofford writing the program code that would be used to run the equipment we were designing. This was one of the most enjoyable and creative times in my working career. Jocelyn and Daniel joined us for a few months and we all lived in an awful one room motel called “The Grimy Brook Motel”!

Walt and I set about to write the program code to run the new lathes we were building. For both of us this was new territory. Our approach was to write thousands of lines of code (in PASCAL programming language) then we would print out metres and metres of the code and resulting calculations and then we hung these print-outs on the walls and scrutinised line-by-line the coding we’d written. It was a great team at Spofford, and even though they all had an acutely well-developed sense of humour, they must have thought Walt and I were bonkers!

Needless to say we were successful in producing the working code required to make the machines function. The team, the environment and the leading edge work we were undertaking proved to be for us all the highlight of our working career – we have all remained life-long friends and dare I say, continue to hone the wacky sense of humour we all had a part in – Walt and I tried to establish a business to export sheep dip to the Falkland Islands, Walt wrote program code to make the stepper motors in complex lathes play “God Save the Queen” by tweaking the noise that the motors made when they were rotating and our designer, Jay Mosbaugh’s well-developed bowels could produce a variant of methane that could empty a building!



The Grimy Brook Motel! – easily the worst motel I have ever stayed in



Spofford Office





Edwin Land

I also teamed up with Dr. Richard Weeks, a highly qualified engineer who had worked alongside Edwin Land, the founder of Polaroid. Through Richard I got to meet Edwin Land and was given the opportunity to be shown through the entire Polaroid research centre in Boston. Richard and his wife Betty lived on Westport Island, near Wiscasset in Maine. We were regular visitors to their home and were treated to trips in their 100-year-old sail boat up and down the coast of Maine. Betty was an accomplished harpsichord player. Together Richard and I developed the computer framework for the entire range of equipment we were building.



Dr Richard Weeks and Michael Dent

It was about this time that I began writing a book on the mathematics of optics. I derived many formulae for all aspects of physical and theoretical optics and created a reference source for the collected knowledge of vision mathematics. I completed the book while in Albany, New York. The work I did in the book has since become the foundation of most contact lens manufacturing systems used worldwide. ([click here for link to full book](#))

INTRACULAR LENS BASICS

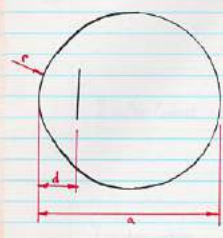

Infinitely thin lens

$$D = \frac{1000n(4r-a)}{(a-d)(4r-d)}$$

D = Dioptric Power of IOL in aqueous or vitreous.
 n = Refractive index = 1.336
 r = Corneal Radius
 a = axial length
 d = distance from anterior vertex to IOL

2. Emmetropia $D = \frac{1000n(4r-a)}{(a-d)(4r-d)}$

3. Ametropia at cornea $D = \frac{1000n(4r-a - 0.0034r \cdot R_c)}{(a-d)(4r-d - 0.003d \cdot r \cdot R_c)}$

4. Ametropia at vertex $D = \frac{1000n(4r-a - (v(4r-a) + 0.0034r)R_s)}{(a-d)(4r-d - (v(4r-d) + 0.003d \cdot r)R_s)}$

v = Vertex Dist.
 R_s = Power Correction at Vertex
 R_c = Power Correction at Cornea

$$R_c = \frac{1000n(4r-a) - D(a-d)(4r-d)}{1000(0.0034r) - D(a-d)(0.003d \cdot r)}$$

$$R_s = \frac{1000n(4r-a) - D(a-d)(4r-d)}{1000(v(4r-a) + 0.0034r) - D(a-d)(v(4r-d) + 0.003d \cdot r)}$$

VOLUME OF SPHERO-ASPHERE LENTIC LENS

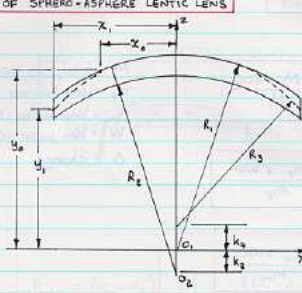

V_l = Volume of lens
 V₁, V₂, V₃ = Partial Volumes
 R₁ = Anterior Radius
 R₂ = Posterior Apical Rad.
 R₃ = F.S. Flange Rad.
 x₁ = 1/2 FCOO
 x₂ = 1/2 AOD
 c = shape factor
 e = eccentricity
 k₁, k₂ = Apical Displacement

$$V_1 = \frac{2\pi R_1^3}{3} \left[1 - \left\{ 1 - \left(\frac{x_1}{R_1} \right)^2 \right\}^{3/2} \right]$$

$$e = \sqrt{1-c} \quad c > 0.0$$

$$e = \sqrt{1+c} \quad c < 0.0$$

$$V_2 = \frac{2\pi R_2^3}{3c^2} \left[1 - \left\{ 1 - \left(\frac{x_2}{R_2/\sqrt{c}} \right)^2 \right\}^{3/2} \right] + x_2^2 \pi k_2$$

$$V_3 = \frac{\pi}{4R_2} x_2^4 + \pi x_2^2 k_2$$

$$V_4 = \frac{2\pi R_3^3}{3} \left[\left\{ 1 - \left(\frac{x_1}{R_3} \right)^2 \right\}^{3/2} - \left\{ 1 - \left(\frac{x_2}{R_3} \right)^2 \right\}^{3/2} \right] + \pi k_1 (x_1^2 - x_2^2)$$

$$V_A = V_1 + V_2 - V_3 \quad \text{or} \quad V_A = V_1 + V_4 - V_3 \quad \text{for } c=0.0$$

Some of the pages from my book on Contact Lens and Optical Formulae I wrote while in Albany, New York, USA

CONICS

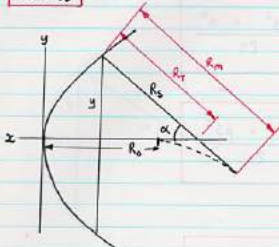

e = eccentricity
 R₀ = apical radius
 R_s = saggital radius
 R_T = tangential radius
 R_m = meridional radius
 y = 1/2 diameter
 n = refractive index
 f = focal length

$$R_0 = f(1+e)$$

$$p = 1 - e^2$$

$$px^2 - 2R_0x + y^2 = 0$$

$$R_s^2 = R_0^2 + e^2y^2$$

$$R_T = \sqrt{R_0^2 + e^2y^2}$$

$$e = \frac{\sqrt{1 - \frac{R_0}{R_m}}}{\sin \alpha}$$

$$R_m = \frac{R_T^3}{R_0^2}$$

$$R_T = \frac{R_0}{\sqrt{1 - e^2 \sin^2 \alpha}}$$

LENS ABERRATIONS

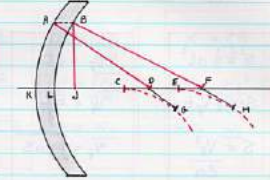

$$R_s^2 = R_0^2 + e^2y^2$$

$$R_T = \frac{R_s^3}{R_0^2}$$

$$L.Sph.Ab = 1000 \left[\frac{R_0^2 n(n-1) + R_s^2 n(nm-n) - ct(n-1)(nm-n)}{R_0^2 R_s^2 n} - \frac{nBcOR(n-1) + nFcOR(an-n) - xt(n-1)(n-am)}{nFcOR \cdot BcOR} \right]$$

$$L.Ast.Ab = 1000 \left[\frac{R_0^2 n(n-1) + R_s^2 n(nm-n) - xt(n-1)(nm-n)}{R_0^2 R_s^2 n} - \frac{nR_0^2 n(n-1) + R_s^2 n(nm-n) - xt(n-1)(nm-n)}{R_0^2 R_s^2 n} \right]$$

L.Sph.Ab = Lens Spherical Aberration
 L.Ast.Ab = Lens Astigmatic Aberration
 n = refractive index material
 nm = refractive index medium (1.333)
 FCOO = Front Central Optic Radius (x̄c)
 BCOO = Back Central Optic Radius (x̄b)
 y = 1/2 Diameter to measure Aberration (ȳ)
 ct = Centre Thickness (x̄t)
 xt = Thickness at y (x̄t)
 e = eccentricity



*Me, baby Daniel, Richard (Dick) and Betty Weeks in
Maine, USA 1981*



Walt and Patty Lewandowski

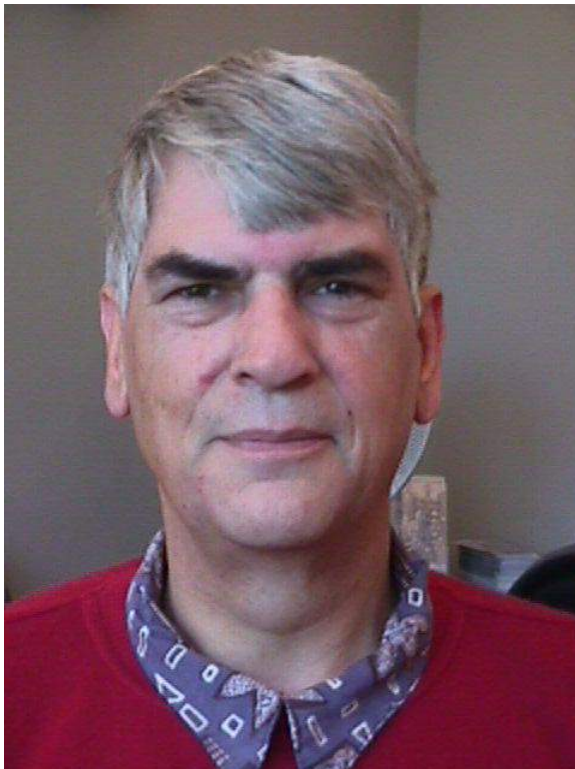

*My good friend and UK Company Accountant - Andrew
Stewart*



NZ-UK Diplomat - John Waugh

I made many round trips from England to the USA during this period clocking up 1000's of flying miles. Back at base in High Wycombe we now had quite a team. Programmers and engineers and we soon had the first of a range of equipment built and running. Many long hours were spent getting there and we were breaking new ground and making significant advances in technology as each day passed.

I was assigned the task of selling the equipment around the world, a position that would see me clock up millions of flying miles. I visited, lived in or worked in every one of the 50 States of America, most provinces in Canada, China, Russia, Japan, most countries in Europe including the Eastern Bloc and notwithstanding having the opportunity to see almost all of the United Kingdom. I had so many stamps in my passport that I required 2 additional passports to have room for the stamps. I also made 4 or five trips back to New Zealand (one of which gave me the opportunity to sell my Glenfield house). In one particular week I made two complete round trips between UK and NZ – that was a horrible experience – double jet-lag and almost 100 hours of flying!

During this time, I worked with Igel, a UK company specialising in the development of soft contact lens and gas permeable polymers, American Optical, Bausch & Lomb, CIBA, Cantor & Silver, Nissel, Hydron and many other leading lens groups. I also worked closely with Pilkington Glass in North Wales in a revolutionary new lens manufacturing facility established in Ruthen. I flew to Budapest (Malev Air) and negotiated a deal to sell a large number of our CNC lathes and ancillary equipment to establish the first contact lens laboratory in Eastern Europe. I negotiated the deal with Gabor Varsegi, a prominent businessman who owned a chain of photo retail stores. We built a beautiful new laboratory in Budapest and I made a number of new lifelong friends there in the process.



Part of the Hungarian Laboratory

It was also at this time that I was actively involved in further developing our technology. We used specialised diamonds for cutting tools and rather than use spindles on the lathes supported by traditional bearings, we chose to use air bearings – the spindle rotated in an envelope of compressed air.

To research technologies that we could use I travelled internationally and throughout Europe meeting and working with highly specialised and leading-edge technology companies.

I went to Groningen in Northern Holland to work with Pharmacia, a Swedish company specialising in highly-precise laser cut scalpels and surgical cutting tools and while in The Netherlands, also spent a significant amount of time working with an amazing technology company in Kwijk that used laser beams to accurately manufacture super-fine diamond cutting tools. It was fascinating seeing 1000's of gemstone diamonds being shaped into specialised tools.



Diamond cutting tool shaping the surface of a contact lens button

I landed in Basle, Switzerland and drove south to La Chaux-de-Fonds a Swiss city in the canton of Neuchâtel located in the Jura mountains a few kilometres south of the French border. I was here to work with a group of uniquely skilled precision engineers who were working on the design and development of our new air spindle.

From here I flew to Budapest to help the building, training and installation of our equipment in the new contact lens lab. (I returned to Hungary for a 2-week holiday a couple of years later)

Next was a long flight to Kurashiki, Okayama, Japan to meet with Kuraray, an enormous producer of functional resins, chemical products, man-made leathers, synthetic fibres and textiles and chemicals manufacturer who employed more than 11,000 people. They had made the decision to start manufacturing contact lenses and we were chosen as the equipment suppliers.



Developing the mounting system – the green modules were the prototype disposable collets (see also below)

I developed a unique mounting system for the new lathes based on a disposable collet - it was an immediate success and I obtained a patent for the device – but once again I got thwarted by the company suggesting that they should own the patent. This time I persevered and retained ownership of the patent. But no royalties – the company won the right to have exclusive use of the invention. Tens of millions of the device have since been since manufactured.



During this time, I wrote thousands of lines of program code (in Pascal) and became one of the first people in the world to use CAD (Computer Aided Design). I was the first registered user of Autocad in the UK. I used the software to develop a range of intraocular lenses – an accomplishment that was published, including being featured on the front cover, in the “Engineers Digest”, a renowned publication read widely by professional engineers. Again, this was leading edge technology. I also completed a number of advanced management, sales and marketing courses while I was in the United Kingdom.

United States Patent [19]
Ian L. Handricks

[11] **Patent Number:** **4,619,082**
 [45] **Date of Patent:** **Oct. 28, 1986**

[54] **METHOD OF MANUFACTURING A CONTACT LENS**

[75] **Inventor:** Ian L. Handricks, Chalgrove, England

[73] **Assignee:** Contact Lens Supplies Limited, England

[21] **Appl. No.:** 663,780

[22] **Filed:** Oct. 23, 1984

[30] **Foreign Application Priority Data**
 Oct. 24, 1983 [GB] United Kingdom 8328365

[51] **Int. Cl.⁴** **B24B 1/00**
 [52] **U.S. Cl.** **51/284 R; 51/216 LP**
 [58] **Field of Search** **51/284 R, 284 E, 326, 51/216 LP, 217 L, 229, 237 R, 277; 264/1.1, 2.7; 82/1 C, 11**

[56] **References Cited**
U.S. PATENT DOCUMENTS

1,911,153	5/1933	Hill	51/284
3,030,859	4/1962	Elliot, Jr.	51/284
3,064,531	11/1962	Bullock	51/284
3,100,955	8/1963	Kratt	51/237 R
3,662,040	5/1972	Urbach et al.	51/284

Primary Examiner—Frederick R. Schmidt
Assistant Examiner—Robert A. Rose
Attorney, Agent, or Firm—Welsh & Katz, Ltd.

[57] **ABSTRACT**
 A contact lens is manufactured by a method involving machining a first face (2,3) and a reference surface (4) on a blank (1); mounting the blank (1) in a work holder (10) adapted for accurate mounting on a lathe such that the blank (1) is held with its first face (2,3) accurately positioned relative to a datum point on the lathe; and machining a second face (8) on the blank (1). Such method avoids the need for skilled operatives and enables easy manufacture of accurately dimensioned contact lenses.

2 Claims, 5 Drawing Figures

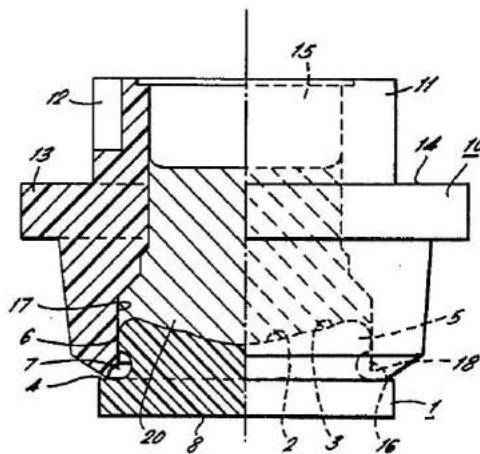

At 3 minutes to midnight on Halloween, 31st October 1983 we welcomed a new addition to our family. Our second child and first daughter, Helen Ruby Handricks was born at the John Radcliffe Hospital, Oxford, England 6 weeks premature. She was very small and immediately placed into an incubator in the SCBU (Special Care Baby Unit) at the hospital. She spent the next 2 weeks there building her strength and body weight and was eventually released into our care. Helen was completely different to Daniel – she rarely screamed and had a determination and personality of her own. She immediately took a dislike to her bassinet ... and cot ... so we simply started her sleeping life in a bed! Helen's name was chosen to honour her great grandmother Ruby Staggard and Jocelyn's (talkative) Great Aunt Helen.



Helen was a tiny baby



Éloïse and me

Two years later on 11th October 1985, our third child and 2nd daughter, Éloïse Adèle Handricks was born also at the John Radcliffe Hospital, Oxford, England. Complications arose just before her delivery and she was eventually delivered by caesarean section. Mum and daughter both did well with the excellent support of nurses and doctors. Her name, Éloïse Adèle, was chosen by me – the Éloïse part from a song I loved by an English singer, Barry Ryan and Adèle part so that I could complete the line of accents above the letters in her name (I had a battle with the registrar of names in the UK who refused to place the accents on the name – I won that battle and they remained!). We did have one more child, however it died before term.

The house was now full – and overflowing, however we enjoyed our time there and made many lifelong friends in the village. I played darts for the local Pub team and we as a family were regular visitors at the many pubs in the areas where we partook of the wonderful meals and toasty warm lounges in the winter months. Jocelyn got involved with the play centre in the village and Daniel started his schooling at the village primary school. As a family we travelled extensively around England, Scotland and Wales and each of us made many trips to Europe and abroad.



Jocelyn, Daniel and me - Dargaville 1981

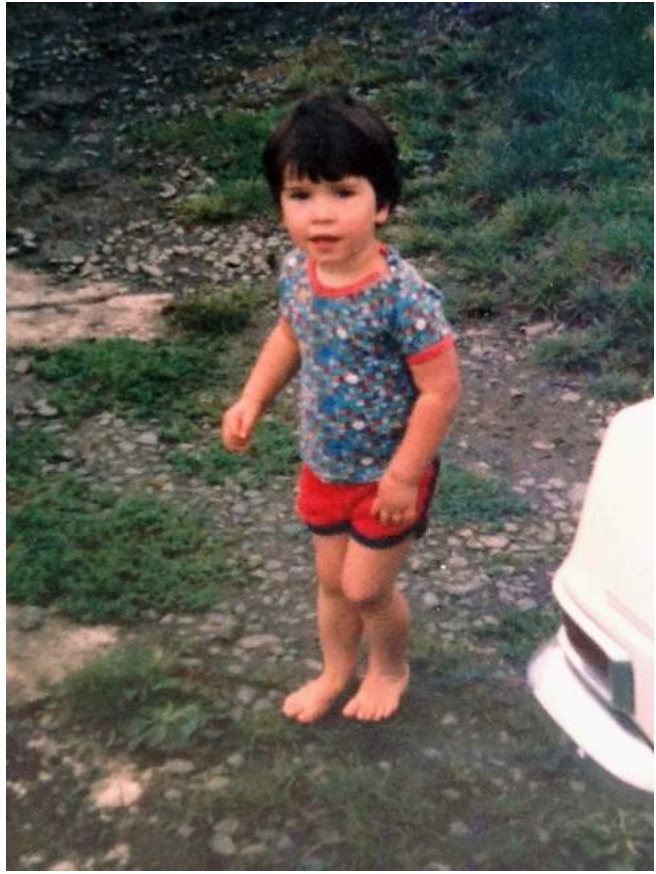

Daniel

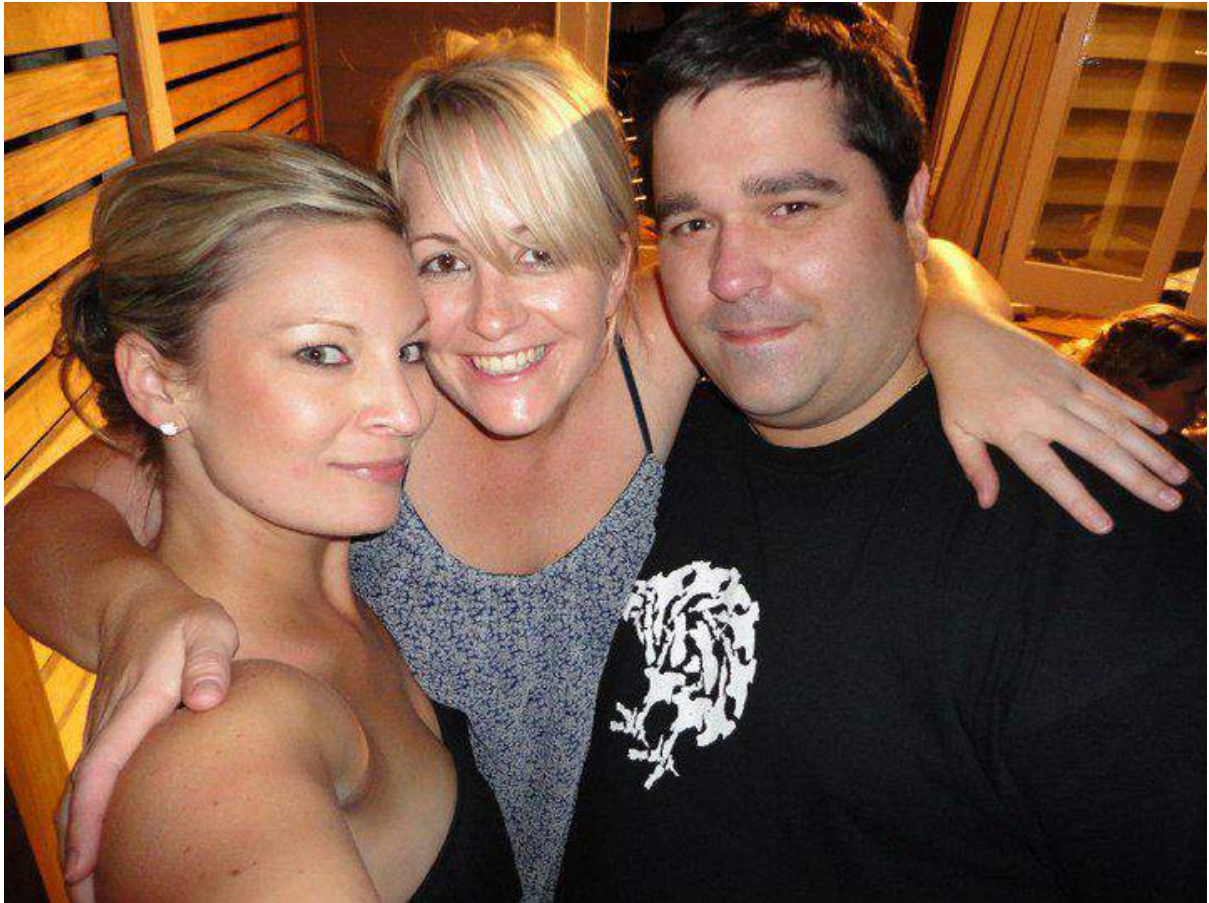

Daniel

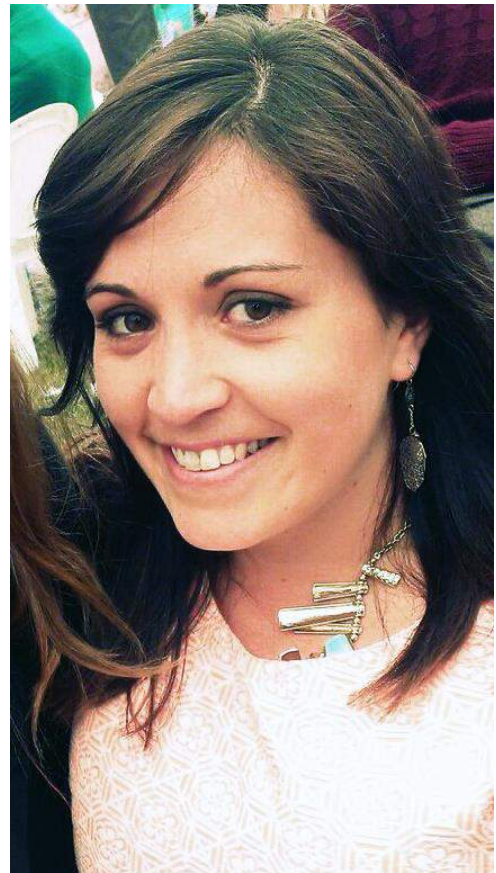

Helen



Éloïse



Me with Helen and Daniel - Chalgrove, England 1982



Helen



Helen



Helen & Eloise with cousins Kelly & Jodi Hackett



Eloise



Helen & Eloise 1991



Me and Eloise



Eloise and Helen



Helen

When visitors arrived we took the opportunity to host them with trips around London and further afield. I paid for my parents to come to England – two separate trips since neither wished to travel with the other. For them both it was their first ever trip abroad. Mum got to visit Paris and climb the Eifel Tower with her new grandchildren and most importantly she got to visit the theatres in the West End of London – the highlight of her visit. Having my father there was a mistake. He was grumpy and quite scathing of the life in the UK. I instructed him with careful notes on how to get the train from London back to our home in Oxford – he refused to follow instruction and instead boarded a train bound for Cardiff in Wales and when he worked out that he was lost boarded another train ... he fell asleep on the way and eventually ended up in Edinburg, Scotland! We were very pleased to see him head home – it was not a pleasant experience.



Mum in Paris with Daniel

While in the UK, I developed Practice Management software for Optometry – the first of its type anywhere in the world. It was developed on a small luggable computer which only had two 5 1/4" floppy disks. It was slow but it worked. The company established a large optometry practice in Reading, Berkshire and the software was central to its operation and success.



In Las Vegas working on Practice Management Program

By this time the engineering plant in our building had expanded significantly and we were developing and manufacturing a wide range of advanced equipment. I was spending weeks at a time flying to all corners of the planet promoting, selling, installing and providing training for the equipment. I was also programming on-site and integrating local lens designs into the software. I flew tens of thousands of flying miles during

this period. We had also opened a large new facility in Atlanta, Georgia. We had a warehouse, small engineering plant and a modern showroom. I flew between London and Atlanta twice a week for months on end – I built up a massive number of air points with Delta Airlines. Most trips would stop at La Guardia airport in New York and then I would take a flight from JFK airport to Atlanta. In between the two flights I regularly took a helicopter trip into Manhattan and shop for books!

While in Atlanta we secured a massive contract with an American conglomerate, Visiontech, to build the world's first fully automated contact lens production facility. It involved installing dozens of our new Polytech lathes and ancillary equipment and in so many ways it was a ground-breaking advance in manufacturing optics.



Part of the huge Visiontech installation

Robert Nyenkamp (the son of Will Nyenkamp, a supervisor and long-term employee of Hirst Contact Lens in New Zealand) and I spent many months in Atlanta commissioning and installing the equipment. We were there so much that the company acquired an apartment at Royal Peachtree Corners and vehicle so that we had somewhere to stay when we were there. Unfortunately, the management and funding behind the operation was suspect and eventually the facility went into receivership and had to be shut down. All the equipment was auctioned.

We had operational equipment in Raleigh, North Carolina, Springfield, New Jersey, Portland, Oregon, Boston, Mass., Columbia, Ohio, Kurashiki, Japan, Budapest in Hungary, Groningen in The Netherlands, Manchester, Liverpool, London, Brighton, Hertfordshire, Menicon in Japan and many other places. I seemed to spend my entire life in the air and I began to seriously dislike waiting for hours in airports. However much I try, I cannot sleep on planes, so some of the longer trips became incredibly boring. The longest non-stop flight I ever took was 19 hours from Tokyo to New York with Northwest Orient Airlines. The most stunning flight was a daytime flight from London to Los Angeles over the North Pole – a window seat and not a cloud in the sky – the scenery was stunning and you could clearly see where the permafrost ended because the trees suddenly appeared in a distinct line somewhere in northern Canada.

My career in the UK and beyond can be summarised as follows: In my role as Group Technical Sales Manager / International Sales Manager, I developed the home based European market to sales of £630 K from its base of £100 K and initiated new export sales of a further £520 K in highly competitive markets. These results were achieved through extensive travel on behalf of the company to America, Canada, Japan, Europe, South East Asia, Australasia and throughout the United Kingdom. This contributed to the company's overall profit and developed the growing chain of specialist agents.

I opened new markets in Eastern Europe, UK, Japan and USA and was responsible for many aspects of marketing including forecasting, planning, surveys, analysis, advertising, sales promotion and agent incentive programs with comprehensive reporting systems. Also contributed to the organisation and presentation of local, national and major international exhibitions and trade shows.

In my role as Computer Services Manager / Group Sales Executive, I established a department of five senior graduate programmers, designing comprehensive programs for a wide variety of applications including machine control, and robotics. Amongst many other specialist applications I originated and configured for the organisation a complete package of CAD using AutoCad, subsequently training operational staff. Using Pascal, I wrote comprehensive programs including applications of numeric machine control, data processing and network planning. Also responsible for the development, sales and marketing of an original suite of Optical Practice Management programs which was introduced and sold to UK and Australasian markets. I Managed and contributed to the development of a complete manufacturing unit, laboratory and quality control facility of 9 staff in line with company growth and within budget. I also organised and instructed a series of courses designed to cover all aspects of product, commercial and computer operations. This also included technical presentations to senior members of the industry.

Functioning as section leader, I was responsible for directing a team of specialist technicians covering all aspects of development which culminated in the introduction of a number of products primarily in the field of lens and production system design. Two of my original inventions, a bifocal lens design and production blocking method were subsequently patented worldwide.

In my role as Special Lens Production Manager, I Was responsible for the pre-clinical evaluation and design, production development and management of a revolutionary lens design for the correction of astigmatism. Also working in conjunction with Dr Michel Guillon of The Lens Research Clinic, London, I contributed to the development of advanced aspheric rigid gas permeable lens designs which were subsequently presented in a joint paper to the British Contact Lens Association. This work required the creative development of advanced formulae and programming.



Dr Michel Guillon

It was a logistical nightmare trying to balance home life with young children and the frenetic pace at which the business was growing. But we managed and made the most of every opportunity. The closure of Visiontech in Atlanta had a devastating effect on the company as a whole. We had made a significant investment in the equipment and funds were not forthcoming and as a result the company began to crumble. Various segments of the business were sold off or shut down. First to go was the spectacle manufacturing followed soon after by the closing of the contact lens lab. We shut down engineering and programming and I made the decision to sell our house in the UK and return to New Zealand. Jocelyn was not happy with the decision having now established a wonderful group of friends in the village, however I realised that we needed to have employment and a steady income to survive.

I contacted NZO back in New Zealand and advised them that I was returning. They could not guarantee me a position but did offer me the opportunity to write a business plan for the contact lens lab.

By this time, the operation in the UK had drained the NZ business of much of its cash reserves and the business in New Zealand was struggling for survival. The contact lens business was doing OK but corporate management had little knowledge of the product nor did they appreciate the craftsmanship element of the product.

I could see an opportunity to buy the contact lens division by the way of a management buy-out from NZO and re-establishing it as an independent company once again. I approached John Shennan, my mentor and early teacher, and asked him if was willing to partner me in a buy-out of the lab. He was keen and we set about raising the capital required. We were fortunate to secure financial backing to complete the purchase to enable us to run and develop the business.



OPTICAL HOLDINGS LIMITED
Lincoln Road, Cressex Estate,
High Wycombe, Bucks. HP12 3QU



Joint Administrative Receivers appointed 2nd March 1988

TO WHOM IT MAY CONCERN

I confirm that Mr. I.L. Handricks has been employed by this company for the past five years, having been transferred from an associate company within the Group in New Zealand, where he had been employed since 1974.

Mr. Handricks originally joined us as EDP Manager, where his expertise in data processing was extremely valuable to the company's diversification into the development and marketing of high precision CNC lathes for the contact lens and intraocular lens markets. Recently, he has held the position of International Sales Manager, which has involved him in extensive overseas travel worldwide selling our equipment and liaising with customers on all aspects of our high technology products.

Throughout his employment with OHL, Mr. Handricks has shown enthusiasm and total commitment to his work. He has been an extremely hard worker, displaying flexibility whenever required, whilst maintaining his dedication at all times.

I would have no hesitation in recommending him to any prospective employer for a similar position.

A handwritten signature in black ink, appearing to read "T.A. Holmes", with a long horizontal flourish extending to the right.

T.A. Holmes,
Director and General Manager

17th May 1988

Telephone: (0494) 20502, Telex: 837 802 OHL LTD G, FAX: 0494 22610
Registered Office as above in England No. 431023



1 August 1988

NEW ZEALAND OPTICAL

STAFF ANNOUNCEMENT

Following restructuring Hirstlens is now poised for growth in the N.Z. Contact Lens Market.

We have been fortunate, for the last 2 months to have secured the immense marketing knowledge and skill of Mr Ian Handricks.

Ian's 16 years in the Contact Lens industry started with Hirstlens and Ian has for the last 8 years been involved with the design and marketing of state of the art technology.

Ian's extensive research into the world Contact Lens market and frequent interaction with the major contact lens manufacturing plants give him a unique insight into world trends which we in New Zealand Optical are eager to convert into growth in Hirstlens.

During his time here Ian has been involved in preparing a comprehensive marketing plan for Hirstlens.

To ensure an orderly implementation we are pleased to advise that Ian has accepted the position of Divisional Manager (Marketing & Sales) for Hirstlens. This position is currently held by Andy Pitcher.

In a further move to focus our efforts in the Contact Lens area Mr Brent Gibson has been appointed Territory Manager for B & L professional eye care products.

In his new role Brent will have responsibility for all sales and promotional activities for B & L contact lenses and contact lens solutions.

B & L sales have grown dramatically since the introduction of their new ranges of lens care products and with this new appointment further sales growth is assured.

Brent has been with New Zealand Optical for 10 years and has for most of this time been involved in the sales and promotion of New Zealand Optical products in the Wellington area and was, until his appointment as Product Manager - Equipment and Instruments, Wellington Area Manager.

Brent's previous responsibilities for instrument and equipment have been transferred to the Area Managers' on a geographic basis.

Sales and promotion responsibility for Ray Ban will continue with the Frames Division.

PHIL CAMMISH
GENERAL MANAGER

▼ ▲ ▼
41-45 LESLIE AVENUE, MT ALBERT, P O BOX 6142, AUCKLAND. TELEPHONE (09) 895.522, TELEX 21604, FACSIMILE (09) 862.755
43-47 HANSEN STREET, WELLINGTON, P O BOX 2594, WELLINGTON. TELEPHONE (04) 897.155, FACSIMILE (04) 893.896
67 MANDEVILLE STREET, CHRISTCHURCH, P O BOX 1476, CHRISTCHURCH. TELEPHONE (03) 488.709, FACSIMILE (03) 486.330

I wrote a business plan for NZO with the clear recommendation that they sell the contact lens division to us. They agreed and in October 1989 John and I became the owners of Hirst Contact Lens. We renamed the operation "Hirstlens". We continued to run the operation from Leslie Ave in Morningside and developed a strategy to build the company.



I regularly showed new Optometrists through the laboratory as part of their degree practical work

The next few years saw a rapid growth in the company beginning with the introduction of a lens that would forever change the shape of the business. At the time, we had a soft lens called CLS40, a popular hydrophilic lens that optometrists enjoyed fitting. It was sold in glass vials with a tear-top aluminium top for \$80 per lens (a comparable price for most lenses at the time). We were also facing increasing competition from imported lenses from multi-national giants such as Bausch & Lomb, CIBA, Nestle and especially Johnson & Johnson with their new disposable lens, Acuvue.

As an aside, one of the main reasons I wanted to buy the laboratory is that when it was in the hands of NZO they were offered the exclusive agency for Acuvue in New Zealand and I was asked my opinion – I said that they must, absolutely must, accept the offer and become the agent in NZ because I had seen how much impact disposable lenses were making in the global market. The management did not take my advice and declined the offer!

I decided that we needed to compete and I suggested to John that we try a new approach to the CLS40 lens we had in our inventory. I suggested to him that we re-brand, re-name and re-package the lens.

I suggested the name “Eylights” (after all they were for the eye and the word “light” conjures the lightweight characteristic of the lens and/or the fact that light flows through the lens) and bearing in mind that all lenses from all suppliers at the time had letter-number combinations for the lens names e.g. CLS40, E5, CC55, etc. Eylights became the first lens to have a name of its own.



Contact lenses are fitted by the optometrist by using a trial fitting set, usually a large wooden/plastic/metal box of many dozens of lenses of differing sizes from which they progressively choose one that fits the best. These trial boxes usually sit alongside the optometrists chair and equipment stand. We had little cash reserves at the time so whatever we tried had to be done on the cheap. We needed a trial box for our newly named lens. I think it was John that saw an advert for a bin full of rejected black video cases on sale by deFrance Ltd, in Parnell. We hived on down and bought the lot! We now had our case but needed to put the lens in a vial. We could not find a large enough quantity of the traditional tear-top glass vials anywhere at a sensible price but we did track down a cute small vial with a white screw top in Germany which we thought would be perfect. We bought as many as we could afford – the German company provided a hefty discount because they had no use for the vials. The added benefit was that once the traditional tear-top vial had been used by the optometrist, he had to re-crimp another new top back on before replacing it back in the trial box – with our new vial he simply re-screwed the top back on.



All that was left to do now was to drill 9 holes in a plastic insert to fit inside the video box to house the vials which we accomplished after a few hours on a drill press. At the time we were experimenting with tinting the soft lenses with a light blue colour so that they could be seen if they were dropped.

This involved some clever use of vegetable dyes and using acid and base mixtures to expand and contract the plastic molecular matrix of the lens. There were some prescribed dilutions that ensured that the colours were consistently very faded. I experimented with the dilutions and found that I could make a dark, medium and light green or blue or aqua lens colour. We decided to offer nine separate shades of colours for the new Eyalights lens. We put nine lenses, one of each colour, into the trial box.

The following year we introduced to New Zealand lenses that could change the colour of your eyes. At the time they garnered some controversy about fitting lenses that had no power and were merely a cosmetic device. This soon passed as the lenses became hugely popular especially with young teenagers. Violet and aqua were the most desired colours and later we discovered ways of imbedding images, logos etc into the lens.



Tinting the soft lenses

In those days the big trial cases offered by the multi-national companies came with an equally large and thick fitting manual – a large book showing how to fit the lenses. We could no more afford to produce nor were we excited about producing such a book. There had to be a smarter way to do this.

When we purchased the business and changed its name I thought that we should develop a new logo for the company. John agreed and I started doodling some ideas. About this time, I was introduced to an avant-garde and eccentric graphic artist by the name of Andy Dunn. I had never met anyone quite like him and his wonderful wife, Paula. He operated from an old villa in Grey Lynn. I approached him about designing us a new logo and together we crafted a spectacular blue, green and black design which reflected the rays of light moving through a lens – in fact the whole concept came from the letter “O” on sheet of Letteraset transfers lying on his bench. This project secured a life-long friendship between me, Andy and Paula and together we have worked on many wonderful and creative projects. I count them as one of my dearest and closest friends.



Margaret Dyason standing next to new logo

The need for a manual prompted me to have a conversation with Andy – I suggested to him that perhaps we could design an adhesive label to fit inside the lid of the video box that had a stylised flowchart that basically said “choose this lens, if it fits, great!, otherwise choose this one”. Andy quickly designed a perfect label with flowchart and also designed a logo for the lens (Black and white for both to save printing costs!).

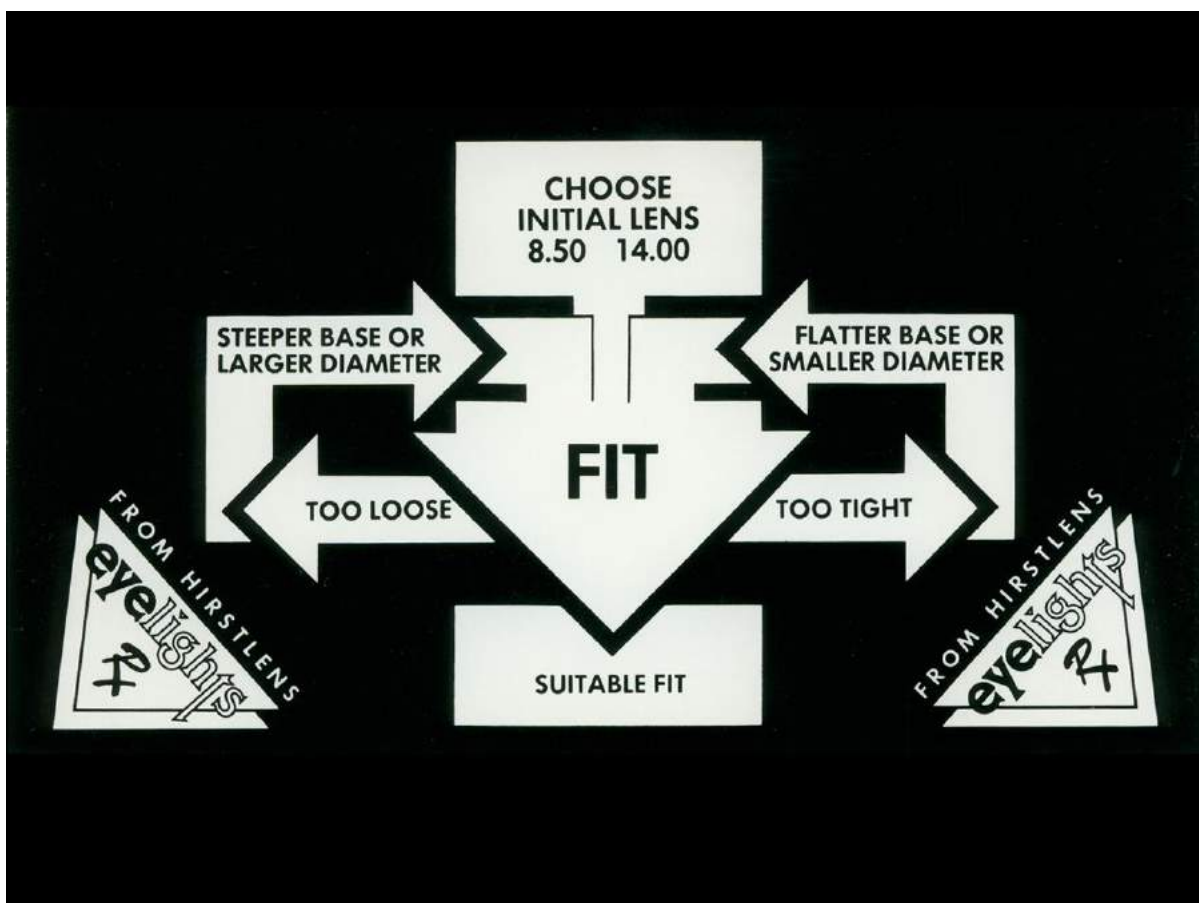

We designed an adhesive label to fit inside the lid of the video box



Paula and Andy Dunn

We now had the product. An important product because we were relying on it lifting the company into sensible profitability and at the same time blunting the invasion of imported product. I suggested one final tweak on the product before we released it – we should sell the lens for \$39 ... less than half the original price and significantly lower than the imported products in the market. John was at first very concerned that we would not make any money doing this, I countered by saying if we capture the market and sell volume we will be in a far better position.

We launched the product on 3rd October 1989 in Invercargill. John and I visited virtually every optometrist in the country on a long tour by car from Invercargill to Auckland. When we showed the product to the first optometrist he said, “I like the black case, it’s nice to see our NZ national colour being used” – when we visited the next optometrist we started by saying, “We chose to use a black case because it is our NZ national colour”. The next optometrist said, “I like the small case, it will sit nicely on top of the other cases I have”. We then realised we had our second selling point, if the case is on top, it will be the first one chosen!

As we went around the country the Optometrists made reference to the “nice small vials”, “the useful range of colours”, “the simple flow-chart fitting guide” and so the lens developed a personality of its own. In very short time it became the biggest selling lens in the company’s history and was the No. 1 choice for most Optometrists in the country. It seriously dented the popularity of imported products and brought prosperity to our laboratory.

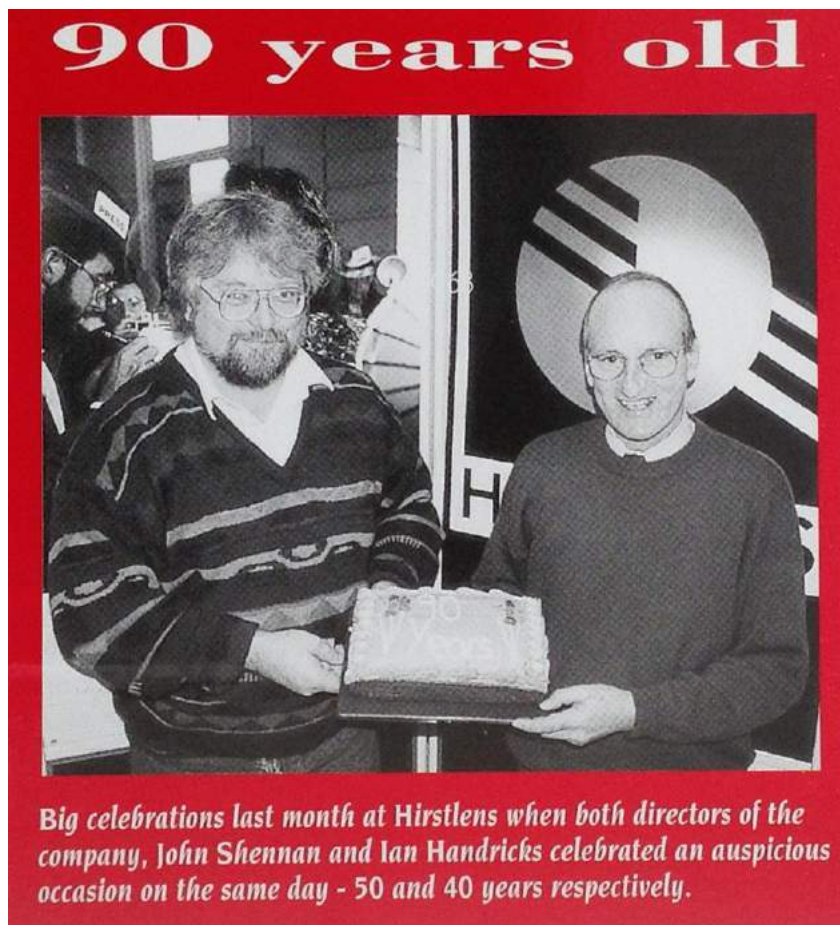

John and I share the same birthday - 6th July!



Above: Me on the day we purchased the business and below: John and I in the cover story of NZ Business magazine



ESSENTIAL READING FOR BUSINESS SUCCESS

NZ BUSINESS

December 1993 / January 1994 \$5.50 (incl GST)

Double Vision
Hirstle's partnership
catalyses his eye

Plus NZB
Special report
on freight & distribution

Directors Beware!

New Company law ahead

Stephen Hirstle
"Directors risk personal liability for decisions which go wrong but the shareholders take the returns from those which go right"

Angua Food Fair
A feast of bright ideas

Corporate Parties
What's cool this year?

YOUR FREE GUIDE TO TELECOMMUNICATIONS



INTRODUCING

DOUBLE VISION

BY DANIEL RYLAND

A partnership of two Auckland businessmen, Ian Hirstle and John Sherman, has been joined by a third partner, the late Peter Hirstle. The company, which has a long history in the optical industry, is now known as Double Vision. The company's success is due to the partnership of the three men, who have worked together for many years. The company's products include contact lenses, optical instruments, and optical systems. The company's success is due to the partnership of the three men, who have worked together for many years. The company's products include contact lenses, optical instruments, and optical systems.

were dealing with was a company committed to the future.

The industry got an indication of what to expect at Hirstle's initial public appearance under Hirstle's and Sherman's ownership — the 60th annual optometrists' conference in Hamilton.

WITH JUST FOUR products of any note, and a recent history of marketplace failure, the two decided to present the company to prospective customers with no products at all.

So they built a five metre high "time tunnel" and lined its walls with a history of optometry, featuring photos of just about everyone in the industry. "It was our way of giving something back to the optometrists in return for what they'd given us," says Hirstle. The stand was packed throughout the conference.

"We talked more about our products than we'd ever talked before in our life. We were dry in the throat at the end of it," says Hirstle. "But we'd proved we didn't need to take product to a conference — and since then we never have."

The next conference was in Christchurch. Although Hirstle must have told the story countless times, it's belied by his obvious relish in the yarn.

"Christchurch was our computer strategy, so we were allocated the far back booth. We decided to go quite minimalist, and took an empty booth with virtually nothing in it at all. But we hired a caricature artist and he drew about 300 caricatures of all the optometrists, with our logo. And of course they were stuck in a chair for 10 minutes and couldn't move, so we could talk to them.

"We said they could have their caricatures — which were big ones, life size —

With just four products of any note, and a recent history of marketplace failure, the two decided to present the company to prospective customers with no products at all.

so long as we could put them up on the wall for the duration of the show. And all of a sudden every square inch of wall, floor and ceiling was covered with these caricatures.

"Even our competitors wanted them



John Sherman (left) and Ian Hirstle. It really is a Laurel and Hardy approach to business.

done — we said sure, provided you stick them up in your booths. So the Hirstle logo was everywhere.

"Then on the [final day] of the conference, when all the deals were about to be

Now, several years on from that first conference when it could have presented no more than four products of any note, the Hirstle catalogue contains over 300 product lines.

Hirstle and Sherman say the response to the company at conferences has allowed it to jump to the next level, and also to broaden its scope from just contact lenses.

THIS DIVERSIFICATION started at an early conference when Hirstle took along a computer to play with behind the exhibit stand while the conference was in session. The interest shown in the computers by the many optometrists lacking in computer literacy led to Hirstle initiating a profitable sideline for the company in computer sales and

software sales.

But even so, Hirstle still managed to lose it, says Hirstle. He attributed the loss to the use of so many small technology-based companies the corporate exchange.

"That was in 1976, when Hirstle and Sherman sold their stake in NZB

to become a company run by accountants."

And it got worse. In 1986 NZB Optical was gobbled up by Corvus Corporation, which fell over two years later. Then new owner Standard Optical of Australia, ditched most of its assets to go into ownership itself.

"Poor old Hirstle was by this stage missing three looking pretty foolish," says Hirstle.

At which point, Sherman and he said enough is enough and negotiated with the receivers to free the company once and for all from its corporate shell. On 1 July 1990 the two became joint owners of the newly incorporated Hirstle.

Having a dual command structure is definitely seen as a positive for the company. Two managing directors is not a recipe for continual fighting.

"If one of us doesn't agree with the other's suggestion, we may find — let's not argue — and we drop the idea," says Sherman.

"There's no defined position for either of us. We don't say that one of us is marketing oriented, or the other is production oriented. We really don't define our roles — to either our satisfaction or our staff. And it works."

"We're almost as different as chalk and cheese as you can find," adds Hirstle. "To really be a Laurel and Hardy approach to business."

Sherman says while he's "not interested", Hirstle is more of the gambler.

Explains Hirstle: "I prefer using a phone to do business. John prefers using a pen. John's a better public speaker than me because he's probably more nervous about it than I am. I'll get up and waffle — he gets up more prepared, and the audience gets more from it as a result."

BUT WHAT OF the increasing care with which Hirstle and Sherman are running the company? The two complemented each other superbly, says Sherman. "Optometrists were coming up to us and saying, 'I'll double my account with you if you can beat me around the track.' They had fun."

The two complemented each other superbly, says Sherman. "Optometrists were coming up to us and saying, 'I'll double my account with you if you can beat me around the track.' They had fun."



Daniel Ryland is an Auckland-based business journalist.

Often problems seem to have no solution. The colleague that cannot seem to adapt to a particular situation, a growing sense of unproductiveness, working with people who cannot or will not change bad habits and a host of other situations where traditional problem-solving methods just don't seem to work. I believe that the problem itself can help find a solution.



The phone was mounted on the wall running up the left of the walkway in this photo

John and I had owned the lab for a little while now and we had about 80 in the team. It was in the years prior to wide-spread cell-phone usage. A wall-mounted telephone was provided by us for all to use in moderation.

One technician used the phone to excess, she was chatting on the phone regularly and her productivity was suffering as a result. Many attempts had been made by me and John tried to rein in her use of the phone – always to no avail. She just ignored our pleas to reduce her use of the phone and continued unabated. Eventually John decided enough was enough and discussed with me the need to terminate her employment. I thought for a moment and decided that there was a better solution – Use the problem to solve the problem. I discussed my idea with John and to say he was sceptical would be an understatement! We called the lady into the office and she arrived with some deal of apprehension.

I said “We have a problem!”, at which point she looked worried, I then said “the telephone was being overused and that was affecting productivity” ... now she was very concerned! I continued by saying, “We would like to promote you to the position of ‘Communications Supervisor’ and ask you to take responsibility for those who use the phone”.

I added, “We would like you to manage the phone, advise anyone using it too long or too often to reduce their usage”. I produced a badge saying “Communications Supervisor” and she was quite taken aback. She thanked us and proceeded to watch that phone like a hawk ... she controlled the usage as if her life depended on it ... she NEVER herself used the phone again! Her productivity went through the ceiling! What’s more, she was delighted to have the power and responsibility and to be recognised for her contribution.

In 1993 I designed and patented a highly successful bifocal contact lens and was a key member of the engineering team that built the tooling and multi-axis lathing systems to produce the lens. This development attracted international press and television coverage. The bifocal design and subsequent engineering design was awarded a Foundation for Research, Science and Technology grant. I must acknowledge the incredible contributions made by John, Denis Malone, John Adam and Lawrence O’Connell and the team of very clever scientists and engineers at Industrial Research Ltd (formerly the DSIR) who under Denis Malone’s expert leadership completed a degree of engineering brilliance that resulted in a successful production system.

On a much sadder note, in 2019 Denis died from Lou Gehrig’s disease – an advanced form of motor neuron disease. I was a speaker and pall bearer at his funeral. A brilliant mind and very close friend no longer with us. RIP.

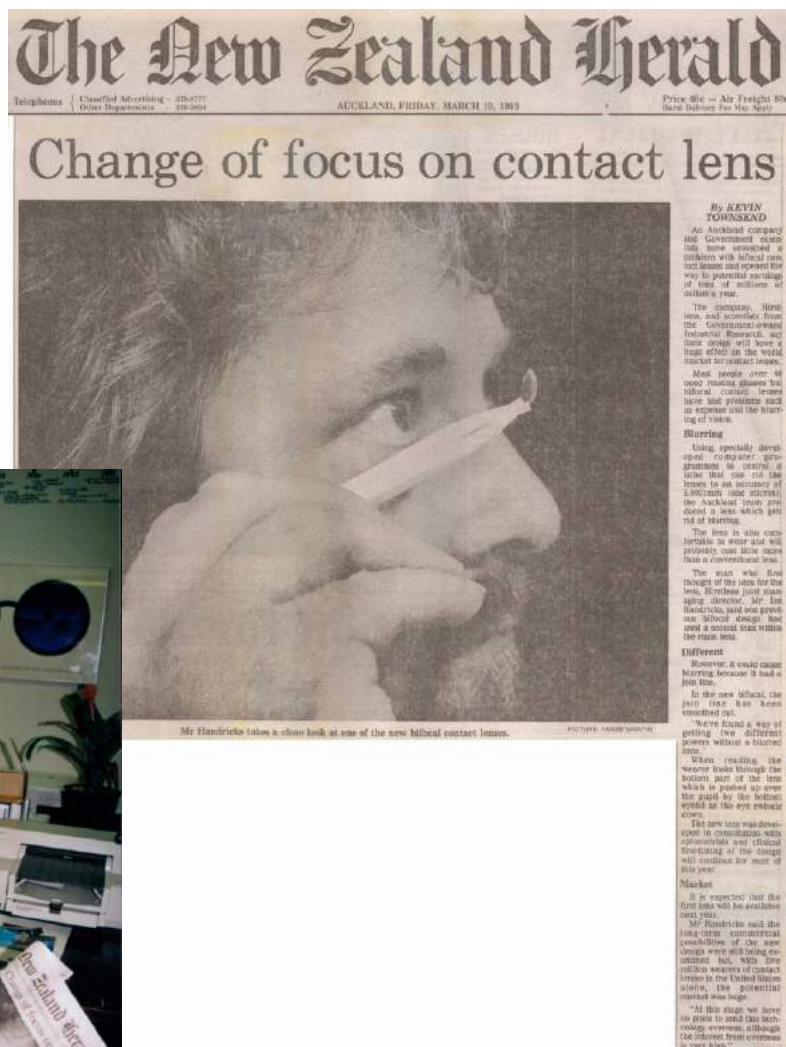

The news of the Bifocal lens and I hit the front page of The NZ Herald and television both here in NZ and across the globe.

SCIENCE & MEDICINE - Scope

Breakthrough On Contact Lens

April 25, 1993

A small New Zealand firm says it has produced an improved bifocal contact lens that would fit most human eyes, an achievement that has eluded large companies dominating the contact lens market. Of the makers of thousands of different types of contact lens products and brands, only five companies produce bifocal lenses, and only a tiny percentage of people's eyes can adapt to them, said Ian Handricks, a partner of Hirstlens, the company that produces the lenses. "The bifocal we are producing is available in any power, in any additional power, in any reading script, in any material," he said. Most people using contact lenses have to surrender them in middle age when they begin to need reading glasses. The bifocal lenses are undergoing clinical trials at the moment. Hirstlens has been manufacturing contact lenses for more than 50 years.



Ian Handricks



Bifocal project now subject to case study

The Horizon Bifocal project has raised a lot of interested within government circles and has been chosen as one of two case studies to be presented to the Minister of Health and his department.

Partial funding of the project has come from a \$109,000 grant from the Foundation for Research, Science and Technology with Hirstlens contributing

an equal amount.

The Horizon bifocal is a one-piece translating/alternating non-aspheric lens which does not employ diffractive optics. The design concept allows for a spherical powered bifocal lens to be made in all materials, soft or hard, and has been designed to be available in any reasonable distance power and any add power.

Proprietary tooling and software design is now in

place giving an opportunity to manufacture early trials.

"Initial production results have shown that mathematical predictions of shape and form are possible and indeed surpass the best expectations. Limited clinical trials have begun and results are expected to show a pattern before the end of the year," said Mr John Shennan, Director of Hirstlens.



FOUNDATION FOR RESEARCH, SCIENCE & TECHNOLOGY

Tuapapa Toha Pūtea, Whakatakoto Kaupapa Rangahau, Putaiao

FAX MESSAGE

DATE: 17 September 1991

TBG90APP0092

PAGES: 1

FAX TO: Ian Handricks & John Shennan
Joint Managing Directors
Hirstlens Ltd
Fx 09862755

Greg Smith
Manager - TBG
Ph 044992559
Fx 044992568

RE: Hirstlens bifocal contact lens project.

Dear Ian and John,

The Board of the Foundation for Research, Science & Technology met on 5 September.

The Board agreed to fund your "Bifocal contact lens" project to the extent of \$109,000 in total. A standard Foundation contact will be sent to you shortly.

The Foundation is most happy to be associated with this project.

Congratulations and good luck with the development.

Regards
GPS

P.O. Box 12-240, Wellington, New Zealand, Telephone (04) 499 2559, Fax (04) 499 2568, 15-17 Murphy Street, Thorndon

In 1991 we were awarded a significant Foundation for Research, Science & Technology Grant for the Bifocal Lens project. This proved so successful that we were proudly presented in the debating chamber of the Beehive as an example of how government funding can and should work!

When we arrived back in New Zealand we stayed for a few weeks at my parents' home in Pakuranga, but that proved to be difficult because my father, in particular, was constantly grumpy that his home had been "invaded" by young noisy grandchildren. We realised very quickly that we needed to buy a house. We searched around finding nothing suitable until one late afternoon after hunting all day we were shown a large house on Hobsonville Road. We had for the last few years been living in a 780 sq ft bungalow in England and we were yearning for a much bigger house. The Hobsonville property seemed perfect. It had 3 bedrooms upstairs, space for another two downstairs, tons of garage space, a huge lounge and even larger room downstairs. We all agreed it was what we were looking for. The sale of my Oxford home had been completed and we were able to buy Hobsonville road for \$105K mostly in cash and a small mortgage.



48 Hobsonville Road

We moved in and rattled around until our container arrived with our possessions from the UK. This time nothing was stolen and everything arrived unbroken and in good condition including my collection of 1000's of books. The children soon settled into school and play centres and we did a little renovation – firstly by adding two bedrooms downstairs and then partitioning the triple garage with a dedicated computer room and office for me. It wasn't too long before we got to know our neighbours and in particular, Trevor and Lesley Willmot who lived a few doors down the road. Their three children and our three were of comparable age and all went to school together, Trevor and I shared a birthday 1 week apart and Jocelyn and Lesley also shared a birthday a week apart. It turned out that the two ladies were related via marriage.

We travelled as a family the full length of New Zealand giving the kids the opportunity to see the natural beauty of the country. Many of the optometrists that I had been working with were by now great friends and we ended up being their guests on many occasions.

Because I had been involved with computers for such a long time, I decided to help all of New Zealand's optometrists to computerise their business. I developed an effective practice management database using a product called "Reflex" and this soon became the standard used throughout New Zealand. I've lost count of the many thousands of hours spent working with virtually every optometrist in the country in teaching them and setting up their computers. I am grateful for their patience and friendship. We even established a nation-wide users group (OUCH – Optometrists Using Computers Helpline!).



On board "Affinity"

At one time, a small group of optometrists and I along with our wives and partners chartered "Affinity", a 70ft launch out of Havelock, a small town in the Marlborough Sounds, for a 4-day mid-winter training session in computers. It was a fabulous trip – we caught an ample supply of blue cod, dived for crayfish and dined on barbequed eye-fillet, cod and crayfish caught during the day. On board was optometrist, Quentin Bennett (co-inventor of the diving dry-suit and renowned underwater photographer) who regaled us with wonderful stories of his diving and underwater photography experiences.

Unlike many professional industries, optometry has always embraced the idea that all sections of the industry should be able to engage and learn from each other. The trades supplying frames, lenses and equipment were always invited to exhibit and partake of the various lectures at the professional conferences and our input on technical matters were always appreciated. We, in particular, worked closely with the School of Optometry and graduate optometrists always spent time in our laboratory learning lens skills prior to completing their degree. One of the supervisors at the School was Alan Bott, a well-respected Optometrist. He and I became good friends and he was a wonderful influence in our lens laboratory. Alan was a skilled engineer and had a particular interest in building miniature railways.



Optometrist & Skilled Engineer - Alan Bott

BUSINESS & FINANCE



COMPUTER GAMES: Ian Handricks, of Beyond Imagination, with one of the company's computer imaging packages. HERALD PICTURE / YANBE MARTIN

Lens pioneer turns eye to computer wizardry

Diversification into developing a range of high-technology computer products by contact lens manufacturer Hirstlens (NZ) is creating opportunities for the establishment of a variety of small businesses.

Since its establishment in 1942, Hirstlens has been at the forefront of innovation in lens. It was responsible for the research which led to the development of the bi-focal contact lens.

In 1994, Hirstlens established a subsidiary called Beyond Imagination, which has become a centre for the development of high-technology computer products.

The flagship product of Beyond Imagination is Photocraft, a personal computer-based system that is able to restore damaged or faded photographs. It has become the basis of many successful small businesses in New Zealand, Australia and England.

Now, Beyond Imagination is seeking to interest people in establishing businesses using its other products, including instant

translation of documents into languages, including Japanese, Mandarin, Korean, French and German.

It has also developed computer programs that can write, record and play back music with orchestration and prepare a manuscript from notes played on an instrument.

Recently, the company put a whole rugby league game on to a computer disc, a technique to enable coaches to study games and manipulate the action to show players their mistakes or successes and what might have happened if they played differently.

A joint managing director, Ian Handricks, said Beyond Imagination was not interested in moving boxes. "Too many do that now. I'm interested in what comes out of the box."

Mr Handricks said Beyond Imagination could provide people wanting to start business based on the technology with a complete turnkey package, including training, hardware and a business plan, to take to the bank manager.

Announcing the launch of Beyond Imagination - NZ Herald 15 Feb 1997

Solution 'glued' together with engineering nous

WHEN contact lens manufacturer Ian Handricks developed the Imagic digital processing system, he did not plan on creating an imaging solution for use worldwide.

Using standard computer hardware and Mr Handricks' own electrical engineering know-how, Imagic has taken off with sales in Australia and Britain as well as locally. "I've really taken what's out there in the market and glued it together in a configuration no one's ever thought of before," he says.

Based on Teco Computer's 486DX 66 mhz computer running Windows, Imagic requires 10 mb Ram and several hundred megabytes of hard drive. Software such as Aldus Photostyler and Pagemaker is included along with a high performance optical scanner and colour ink jet printer. A video capture card is an optional extra.

"Imagic is an extended digital imaging station using some of the most advanced software for video capture, manipulation and morphing. It is most simply described as a multimedia studio,"

Mr Handricks says.

The first version of Imagic was priced at \$25,000 but it is now divided into four pricing categories: a low end system for \$9995; an economy pack for \$15,000; the standard pack for \$21,000; and the optimum version for \$26,000. Each system uses Teco computer hardware ranging from pentium to 486DX 66 mhz machines and to date, more than 50 Imagic systems have been sold both in New Zealand and overseas.

Mr Handricks first made a name for himself when he developed a computer-controlled lathe for the mass production of contact lenses and later developing the bi-focal lens.

However, a new creation called Beyond Imagination has Mr Handricks and his Hirstlens company turning more heads.

Beyond Imagination is a unique environment for interested groups to view and experiment with technology in a technology playground.

The concept began four months ago and was officially opened on



IAN Handricks puts a Teco computer through its paces at the Beyond Imagination facility

May 21. "We [business partners John Shennan and Mr Handricks] felt there was a need in New Zealand to provide a facility where people were not in a true retail environment, where they could get

involved with technology and computers and akin products at leisure, but without being open to the general public," Mr Handricks says.

Beyond Imagination accommodates a maximum of 50 people at a

time; usually groups with similar interests including farmers, plumbers and florists.

It occupies between 10,000 and 15,000 square feet at Hirstlens' Auckland premises.

The first system for Photo Restoration - I called it "Imagic" back then - NZ Herald 11 July 1994

The contact lens and optical manufacturing industries (like most industries) conduct various conferences and in conjunction with, usually run a supplementary trade show where manufacturers and suppliers have an opportunity to exhibit products and services.



Typical trade show stands in 1990

These trade stands are traditionally 3 x 3 metre spaces with plain walls, a couple of chairs and a table upon which products can be displayed. The spaces are usually 'dressed' with a few obligatory posters, a brochure holder or two, a liberal offering of sample products and maybe ... a pot plant! I personally found this style of trade presence lacking style, the presentation boring, showing no individuality and offering little or no attraction to entice customer attention. Moreover, these stands (and furniture) can be expensive to hire and it is probable that the business done at the show (if any) will never recoup the costs of participation.

I also observed that people attend conferences for three main reasons - none of which are to take an interest in the trade exhibits! They are

- to gain further education from the lectures on offer,
- to earn continuing education points required of them by their respective professional bodies and
- to meet with colleagues and partake in social activity.

It is more often the case that exhibitors spend significant money and walk away with a lacklustre response to their exhibit and often very poor attendance to their stand.

After buying the contact lens business, I decided that we would never again attend conferences and offer a trade exhibit that followed the format above. I felt that we needed to deliver a show that met the following criteria:

- A display construction that stimulates the senses
- An exhibit that does not display product
- A display that can generate income over and above the costs of construction and rental
- A display which can hold the visitor on the stand for an extended period

- A stand that can act as a natural venue to allow colleagues to meet
- A display that more often will have absolutely nothing to do with the trade
- An exhibit that embodies a performance and is enjoyed as a show
- A display and presentation that embodies a sense of humour

We attended a number of conferences over the next few years and the following are some of the ideas we developed and used with great success.



The Caricature Conference

The NZ Contact Lens Society annual conference was held and the trade was invited to participate in a trade show running concurrently with the scientific conference. We decided to hire a double-sized stand (6m x 3m) and ordered only two chairs with no other furniture. We also asked that the walls of the stand be completely bare.

We took no product to the show and we took no posters, product literature or brochures. We did however take one very large company logo (2.5m x 1.5m) and placed it at one end of the stand. Apart from our “secret weapon”, our stand was complete. We had some very puzzled comments from our competition mostly surprised that we had no product or related paraphernalia on display. They certainly (and discreetly) questioned our sanity!

Our “secret weapon” was Mr. Stan Hurr, the resident caricature artist at Auckland’s “Rainbow’s End”. We contracted him to be on our trade stand for the duration of the show where he was asked by us to draw large caricatures of the optometrists and attendees at the conference (note, these caricatures usually cost \$50 each at Rainbows end). We arranged the two chairs on the stand carefully so that the person being sketched was facing the giant company logo while their portrait was being drawn – they could not avert their eyes – they had to concentrate on the company logo! We placed an adhesive company logo on every caricature. We also said to each person being sketched that they could have the caricature for free, so long as we could display it in our stand for the duration of the show. To this they all readily agreed. Gradually our stand filled with portraits of everyone attending the conference. It became a place for optometrists to meet and for them to bring their colleagues to “show off” their picture. Our stand was always full of people – we talked ourselves dry about our products and our services.

During the lecture times – a time when the trade exhibition centre was empty – our competitors would come and ask whether they could have themselves drawn as a caricature. We said, “of course” but we made it mandatory that they had to hang the finished caricature (along with our adhesive logo) in their stand for the duration of the show. This they agreed to and suddenly we our company was displayed in every stand at the show.

When the conference came to a close, we made a general announcement to all that they could come back to our stand to collect their caricatures and on-masse we had a big crowd on the stand. We deprived our competition of people to talk with – at the very time when deals should have been completed. We also handled our give-away literature in a unique way! We determined that in most cases literature, brochures and samples picked up at trade shows are discarded or thrown away within minutes of them being avidly collected by the attendees.



To address this, I decided (with Andy Dunn’s inspiration) that we should print our brochures on the ultimate throw-away – a frisbee!! We ordered and printed with our messages a significant number of frisbees and gave them to the optometrists (an unplanned frisbee-throwing event began on the trade show area as a result!)– to this day (25 years later) many still have that same frisbee. Talk about longevity of message!

The increase in business due to that show more than covered our total show costs forty fold! I believe the increase was due to success of the stand – it fulfilled most of the criteria above. It was a display construction that stimulated the senses, we did not display product, it generated income over and above the costs of construction and rental and it held the visitor on the stand for an extended period. The stand acted as a natural venue to allow colleagues to meet, caricatures have absolutely nothing to do with optometry, it was an exhibit that was a performance and it was enjoyed as a show and was a presentation with a sense of humour.



Optometrist, Mark Eagle (left) and me helping another optometrist with his computer



Me with Joanne Boughey and my friend and optometrist, Brian Gifford

THE OPHTHALMOLOGICAL
SOCIETY OF
NEW ZEALAND

FORTY FOURTH ANNUAL
SCIENTIFIC CONFERENCE

10-13 OCTOBER, 1990
CENTENNIAL CONVENTION CENTRE
PALMERSTON NORTH



PROGRAMME

Over the years I have done a significant amount of public speaking, technical lectures, presentations and specialized workshops on a wide spectrum of topics. In 1990 I was invited to present at the 44th Annual Scientific Conference of the Ophthalmological Society of New Zealand. I asked my friend and NZ Optometrist, Brian Gifford to co-present. This was a particularly important opportunity as lectures and presentations at this level in the industry was almost exclusively done by Ophthalmologists, Doctors, professors and world-leaders in the profession.

Friday, 12th October

6.45 am Breakfast and Panel discussion at the
COACHMAN HOTEL —
Sponsored by 3M
Multifocal Implants *Dr Isaacson,*
Dr Osher, Dr Barrett

CONVENTION CENTRE:

SESSION VII: CHAIRPERSON — Assoc-Prof Richard Clemet
8.30 am The Malpositioned Intraocular Lens
Dr R. Osher

10.00 am TEA

SESSION VIII: CHAIRPERSON — Assoc-Prof Tony Moltenc
10.30 am Automated Perimetry *Dr I. Goldberg*
12.30 pm LUNCH

FINAL VISIT TO TRADES EXHIBITION

SESSION IX: CHAIRPERSON — Dr Tom Ellingham

1.45 pm Presentation of Pharmacia Prize

1.50 pm Some Computer Applications in
Optical Design and Practice

Messrs I. Handricks and B. Gifford

2.20 pm Surgical Management of Intra-

Operative Complications *Dr R. Osher*

3.50 pm TEA



THE UNIVERSITY OF AUCKLAND

PRIVATE BAG AUCKLAND NEW ZEALAND TELEPHONE 737-999

22 May 1989

Mr Ian Handricks
Hirst Contact Lens
STANDARD & NEW ZEALAND OPTICAL

Dear Ian

Thank you for contributing a lecture to the final year Contact Lens Course.

The date suggested was 25th July at 5.30 pm in Room 101 in Maori Studies. The room has a 35 mm projector and an overhead projector. If you require any other visual aids or photocopying done prior to your lecture, then that can be arranged easily if we have two weeks notice.

If you look for me in the Optometry Clinic just before your lecture then I can show you where the lecture room is, how the facilities work and introduce you to the final year students.

Yours sincerely

Kerry Atkinson

I have been invited to be a guest lecturer at Auckland University on a number of occasions. I presented classes on marketing to final year students at the Auckland University Owen Glenn School of Business and lectures for the School of Optometry on lens design and optics.

The Pétanque Show

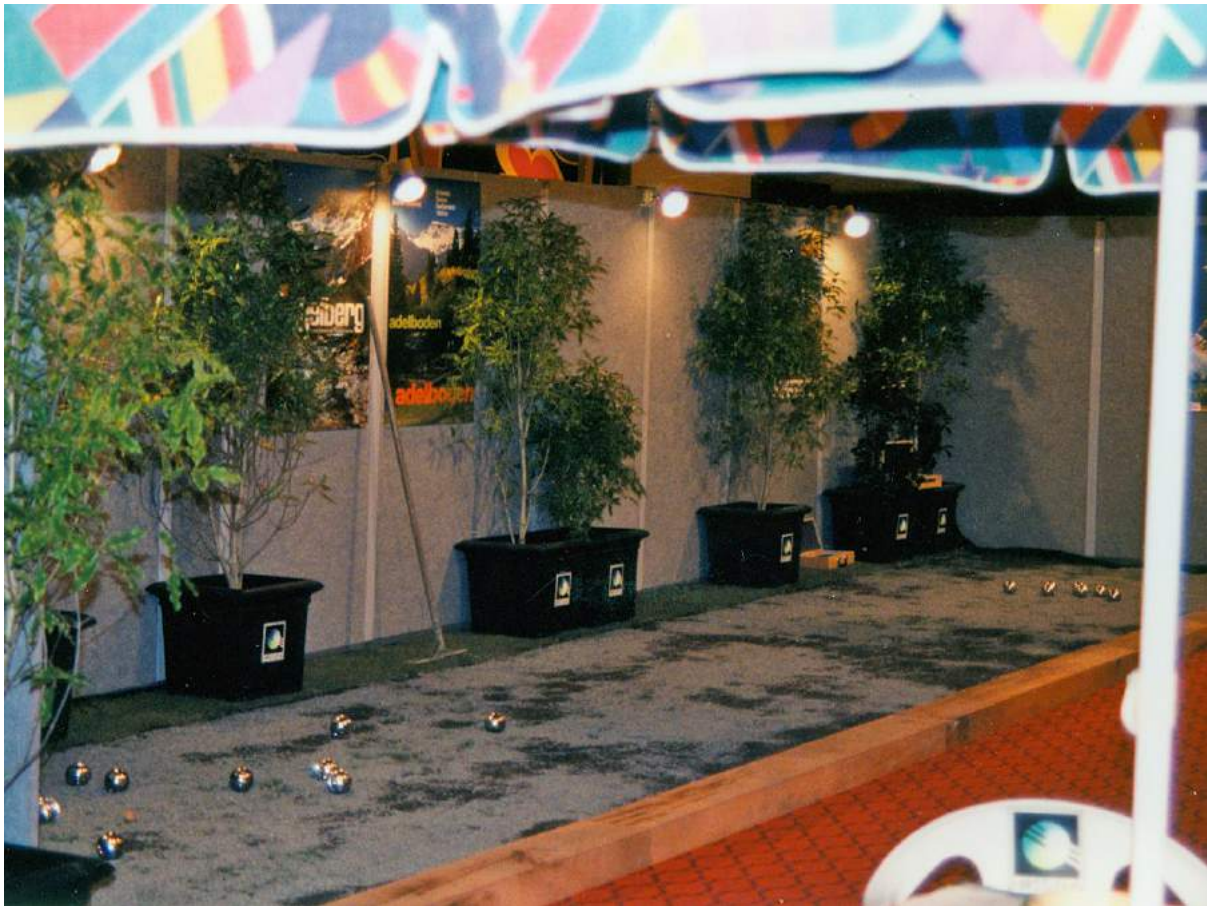

The following year we were invited to display at the annual conference, this time being held in the Christchurch town hall. The trade exhibition was given the mezzanine floor and we chose a busy landing area at the intersection of all foot traffic to and from the exhibition to the lecture theatre.

The area had new carpet and we were a little concerned that the authorities might take exception to our show – but we prevailed! We laid down a large and long plastic tarpaulin, surrounded that with heavy railway sleepers, and then proceeded to dump into that construction wheelbarrow loads of fresh, damp soil and over that more barrow loads of river stones and pebbles. We constructed a full size Pétanque pitch directly on the newly carpeted town hall floor!

We got (again on consignment) every Pétanque set we could lay our hands on and brought them all to the show to play with and to sell. Alongside the pitch, we set up umbrellas and coffee tables and constructed an open-street French café with wine and cheese, coffee and bread. It was somewhere our clients could sit and chat with us (and their colleagues). We had determined that there is often very little sitting spaces available in a trade display. We decorated the Pétanque pitch with posters of French landmarks and proceeded to enjoy some competitive games with our customers.

Again, we took no product, no brochures and no paraphernalia that we would have normally taken to a conference. Instead, we talked ourselves silly about our products and about our services. We made a roaring profit from sales of the Pétanque sets and our business grew another notch as a result.

The Fast-track Show



Fired up from the success of the caricature show, we decided to become even more courageous and rented a quadruple size stand – 6m x 6m and this time we asked for no walls, no furniture and no pot plants!

We constructed out of 50mm x 50mm timber four 3m high scaffolding units (painted white) that could support our theme for the conference – Scalextric Racing cars! We ordered (on-consignment) every single Scalextric Racing set available in NZ (and Australia) and assembled some of them into 4 giant track layouts intertwined in the scaffolding. Making sure we could disassemble for transport, we moved them and re-erected them on the trade exhibit stand. We made sure that the cars were painted in the company colours and that the barriers around the track had advertising hoardings of our products and services.

We took along all the rest of the unopened Scalextric Racing sets with an intention to sell them to optometrists and ophthalmologists with a view to recouping the cost of the stand. This we did – not only selling every set we had on the stand - but also sold the whole stand to one optometrist and took numerous orders for more sets to be delivered later. We sold more sets in 2 hours than the retailer we ordered them from had sold in 2 years!

The optometrists had fun! They spent a great deal of time on our stand racing (and being competitive) and we had ample time to talk about our products and services. It was interesting to note that even though we had broken the ice at the previous trade show, none of our competitors tried to emulate our new approach to trade shows. They maintained the 3x3 stand with minimal products and statuary posters.

We also used this conference to forever change the way our customer had us paying for the service we provided. It had long been a custom that when one of the customers sent a lens in for alteration, re-polishing or such, that we had to pay for the courier costs both to and from the customer – a service cost that we found difficult to comprehend. We decided to launch a service product at the show which we called “Fast Track” (obvious pun with the racing cars). We took a humble pizza box, put into it a selection of packaging materials, paperclips, tape, courier tickets and addressed envelopes and dressed the box with a snazzy chequered flag logo. We then proceeded to sell them from the stand as a better and more convenient method for them to ship lenses to us. We sold a very large number of boxes, not only covering the costs of making the boxes but covered (in advance) all courier costs we had been sustaining.

The revenue from sales of Scalextric Racing cars (and the stand itself!), the Fast-track boxes and the increase in business due to the success of the stand resulted in a sustained doubling of company turnover. Again, this exhibit met all of the criteria I had decided were the elements that would lead to a successful show.

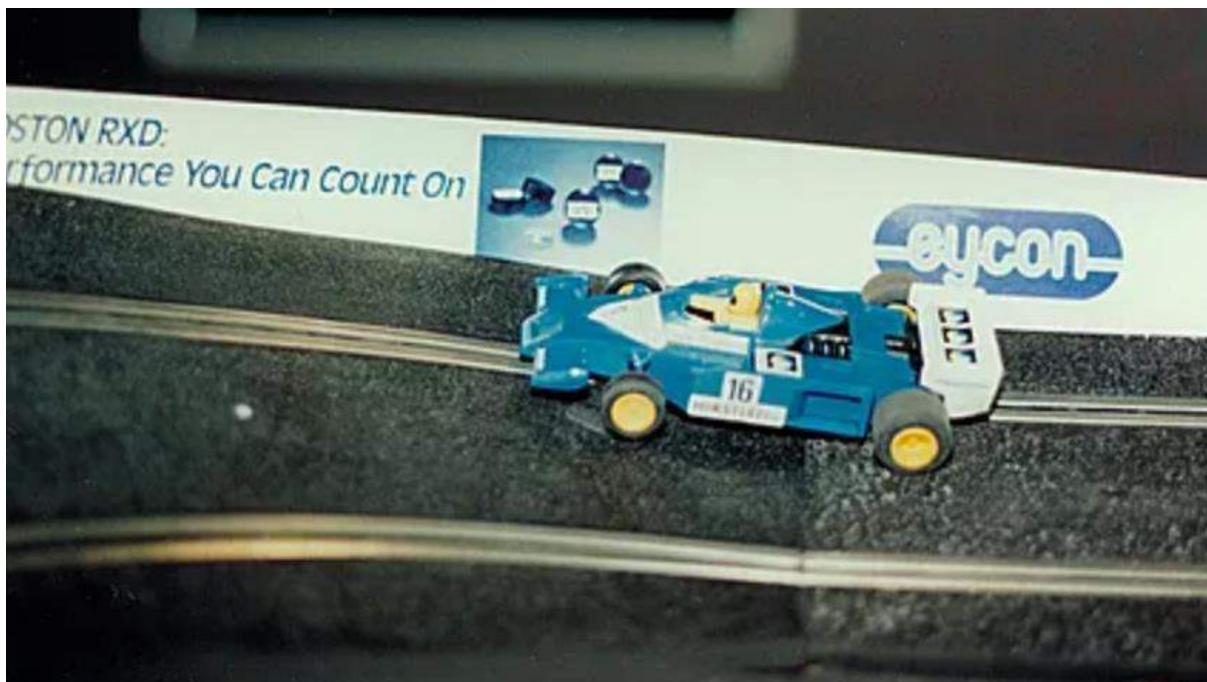

The Bushman's Concerto Conference

Wellington was our next venue - this time at a prestigious hotel in a newly decorated conference facility. This time we chose to keep costs to a minimum and essentially pick up our conference display on our drive from Auckland to Wellington in a rusty old truck!



We collected tree stumps, branches of trees, oil drums, old tools, recently cut forest trimmings, greenery of all types, lengths of pit-sawn timber – indeed any manner of natural bush/forest stuff. When we arrived we constructed a living, smelling replica of a section of NZ native forest. We saved money on hiring furniture by using a chainsaw to hew out tree-stump chairs, we laid rough planks across oil drums to make tables and even put fluffy bunny rabbits in the scene to provide a sense of fun. We hired nothing but the empty un-walled stand!

Prior to leaving Auckland, we arranged to get (you guessed it, on consignment) a significant number of electronic music keyboards (some attached to computers!) to take with us to the show. These we set up at various parts in our man-made forest. The scene was set.

The stand gave forth a pleasing aroma of native foliage, the optometrists playing the keyboards attracted attention (and exhibited some questionable talent!) and the stand became the “come to” place for all to have some fun. We all dressed as lumberjacks – a distinct departure from the obligatory suit and tie.

Again we took no product and instead continued the success of talking until we could talk no more about the products and services we offered. We sold the keyboards (making a handsome profit) and again the show contributed to further business growth.



For another conference I came up with idea that we should make up kit bags of goodies to promote a new lens – the bags are still being used to this day! The great benefit was that the Optometrists walked around the conference carrying our logo everywhere.



At this conference, I designed a monster photo and fact timeline of the company's history and placed on the white-topped table various and obscure objects we used in the lab for making lenses – Optometrists were asked to guess what the objects might be used for – one object was a circular brass ring with four screws around the perimeter ... one optometrist thought it was a thumbscrew we used for optos that don't pay their accounts on time!

By now, the old NZO Group had been dissolved and the building in Leslie Ave was up for sale. The spectacle lab formerly in the rear of the building was now occupied by a sock manufacturing company and we were occupying the whole front section of the building. When the building went on the market, we decided to buy it, the guys in the sock factory were keen on buying that end of the building. The whole building was partitioned into two titles, a huge fire wall placed between the units and we each purchased our end of the building. In short time we decided to build a new and modern laboratory in the former accounts office which was opened by The Rt Hon. Maurice Williamson, Minister for Science and Technology, and Gene Hirst's wife, Jana Hirst.



Part of the new and modern laboratory at Leslie Avenue

We established trade partnerships with a number of lens manufactures around the world and negotiated a deal with the pharmaceutical companies who supplied the solutions used by wearers of contact lenses. We established a warehouse to distribute these solutions and this soon grew into a major part of our business with pallet loads of boxes being shipped every day. We also started importing a range of disposable lenses called "Frequency" which did reasonably well against pretty fierce competition from the multi-nationals.

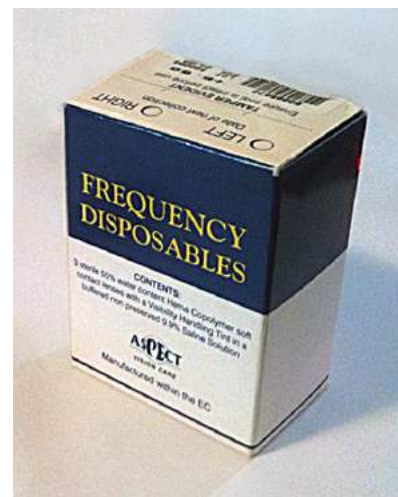

HIRSTLENS OFFICIALLY OPEN LAB

Hon. Maurice Williamson, Minister of Science and Technology, officially commissioned the Hirstlens contact lens laboratory on 12th February.

Former and present staff joined with practitioners and other special guests to witness the event. Among the invited guests were Mrs Hirst, Gene Hirst's wife, and Stan McKee, a former employee who worked for the company for 37 years.

In opening the laboratory Mr Williamson said computers and contact lenses were a strange mix.

"It is unusual for a company to be at the forefront of optics and

information technology."

He went on to elaborate about the information technology age that is sweeping the world and quoting from US Vice President Al Gore "8 out of 10 new jobs will have an Information Technology component."

"Since the turn of this century, there has been an enormous turnaround in employment. In the year 1900, based on US figures which apply elsewhere, over 75 percent of the labour force were involved in manual, either skilled or unskilled, occupations. When we end this century in three years time, it will be less than 24 percent. It is



Mr. Williamson assisted by Mrs. Hirst opening the lab.

a complete reciprocal - managerial, service industries and the information sector have just taken over. Some of the traditional

occupations that we have trained people in for so many decades, will simply disappear."

Announcing the opening of our new laboratory - NZ Optics Magazine



Taking a break from lens work

Our children were growing up fast. Daniel had just started high School and the two girls were well into their primary schooling. They all attended West harbour Primary School and were fortunate to have a run of great teachers and the support of an outstanding principal, Mr Mike Gardiner. Helen, in particular, flourished with her teacher, Mrs Allan-Coombes. Daniel played table tennis and Helen was into soccer, water polo and netball. Eloise, despite being a very, very quiet baby, was now a chatterbox who often dominated the conversation at the table.



Our family

In 1992, I decided that we should start a new technology business. With the work I was doing in helping Optometrists become computer-literate and the amount of computer-based technology we were using in the lab and along with my passions for this technology, I convinced John that we should open a new division and call it “Beyond Imagination” (a slight reference to imaging and the optics of lenses). He agreed and I started to set up a small facility in the front offices of the building. Not soon after an optometrist approached me with a fundus photo (photo of the retina of the eye) and asked whether I could use a computer to enhance the photo. I hasten to add that this was many years before Photoshop existed. I did have a small program called Photostyler and with that and some skulduggery I was able to achieve a better image (scanners in those days were very rudimentary).

I then had another epiphany moment; perhaps I could use this technology to change and restore photos? I spent the next few weeks experimenting with techniques to alter photos and was eventually able to restore damaged images. This would be the start of my next huge business venture. More of this later.

I negotiated deals with Newmarket Computer Centre, Microtek, Ultra Computers and Teco Computers to supply (on consignment) a number of computers, scanners and printers for a new retail centre I was setting up in Leslie Avenue. After much negotiation, cajoling, friendly banter and sweet-talk they all agreed to provide the equipment we needed. I also negotiated the supply of hundreds of boxes of software, electronic music keyboards, cables and connectors and even a range of sunglasses and suitcases! I used a pile of spare benches from the lens lab and tastefully decorated the old boardroom and opened the new Beyond Imagination technology centre in 1996.

I employed a number of people as technicians and sales people and invited a great guy who was working with one of our computer suppliers, Tony Hickmore, to become our Sales Manager. Tony did a great job in shaping the team and we have remained great friends to this day.

The tech support team grew and very soon we had eight technicians servicing equipment and building computer systems. Much of this work came from the rapidly growing number of Optometrists that I was introducing to computerisation. I ended up teaching and setting up computers in almost every optometry practice in New Zealand.

At one point, I had five optometrists sitting in my garage at home until the early hours of the morning building their practice management systems and writing code for their databases. These were crazy times!

I also began experimenting with applications for computers in a diverse range of businesses – teleradiology, practice management, digital music and musical keyboard control (I managed to get a computer to read a sheet of music then automatically play it on an electronic music keyboard!), MIDI platforms, database constructions and much more. We were working at the bleeding edge of computers – there simply wasn't enough power/memory or precision to achieve what we were trying to achieve.

Long, long before the internet was even understood, in fact well before the release of the first IBM PC in 1982, I successfully built an S-100, California Computer Systems CP/M system that allowed me to access and communicate on the fledgling "Source" tele-communications network designed for international conversation and file sharing. This was an all-time first for New Zealand. This was achieved on a screen which could only display simple black and white ASCII characters! Windows had not yet been invented.



Demonstrating the very first Tele-radiology system (looking on are Optometrists Michael Wight, Margaret Raby, Naomi Meltzer, Rodney Gorton, Lex Grocott and Michael frith)



**VIDEO
CONFERENCING**
New Zealand's First Comprehensive Summit

Special presentations from:

- The Hon Roger Maxwell, Minister of Business Development
- John Barrett, Principal, Barrett Support Services, Australia
- Paul Costin, Managing Director, Business by Television, Australia
- Jamie Cousins, Senior Consultant Videoconferencing, Incharge Telecommunications, Australia

Learn how to:

- Explore profitable video conferencing opportunities
- Reduce your operational costs from more efficient communications
- Speed up your decision-making through visual communications
- Implement cost effective video conferencing technology in your business
- Open your business to new markets by video conferencing

4 & 5 July 1995, Hyatt Auckland

Plus 2 LIVE Video Conferencing

H. Luedeck, Senior Manager Business Development, Sony Corporate Europe

John Mitchell, Managing Director, John Mitchell & Associates, Australia

Organized by AIC CONFERENCING A Business Conference

Including Practical Video Conferencing Demonstrations and Applications

In 1995, New Zealand's first ever comprehensive summit on Video Conferencing was held in the Hyatt Hotel in Auckland. I was a keynote presenter on implementing video conferencing as a total multi-media strategy. This invitation came on the back of the ground-breaking work I had been doing with tele-radiology.

8.30 REGISTRATION AND COFFEE

9.00 **Opening remarks from the chair**
Tony Hitchcock
Branch Manager
Software Supplies NZ Ltd

VIDEO CONFERENCING TECHNOLOGY OPTIONS

9.15 **Technology explosion: choices in video conferencing**

- What are the telecommunications requirements?
- The technology options of video conferencing
- Large group systems vs. small group systems
- The emergence of desktop systems

John Barrett, Principal
Barrett Support Services, Australia

IMPLEMENTING A VIDEO CONFERENCING SYSTEM

10.00 **Implementing video conferencing as a total multimedia strategy**

- Video conferencing and the information superhighway
- Integrating video conferencing into your existing multimedia applications
- Using video conferencing to win management support for multimedia
- Cost effective video conferencing using your existing multimedia technology

Ian Handricks, Joint Managing Director
Hirstlens NZ Ltd

10.45 MORNING COFFEE

11.05 **LIVE BY VIDEO CONFERENCE**

CASE STUDY **How to successfully implement video conferencing in your organisation**
This session will feature 3 case study examples from:

- The Queen Elizabeth Hospital Dialysis Telemedicine Project
- The Australian Catholic University
- F.H. Faulding & Co. Ltd

John Mitchell, Managing Director
John Mitchell & Associates, Australia

11.50 **Training and briefing with the best people through business television**

- What are the business television applications and technology?
- Who benefits and why
- Interactivity
- Comparisons to alternatives
- The versatility of connections to other networks
- Practical application examples

Paul Costin, Managing Director
Business By Television, Australia

12.35 LUNCHEON

CRITICAL TELECOMMUNICATION ISSUES FOR VIDEO CONFERENCING

2.00 **A) Network nuts and bolts**

- ISDN lines

From here we ran “Wow” nights where we invited people to experience computer technology and learn about photo restoration and as a bonus tour the contact lens laboratory. These “Wow” nights were a great success and we ended up selling a lot of computers. It was at one of these wow nights in our restoration studio above Harvey Norman where I met Barbara Anderson and Gail Moore, members of Seniornet – more of that later.



Part of the new "Beyond Imagination" enterprise

About this time, I met Graham Fletcher, an Army technician who was nearing the end of his time in the forces. I offered him a job at Beyond Imagination as my right-hand man and technician – he agreed and we are still great friends to this day. Graham is a great technician with an enormous knowledge of computers – I’m certain that he has forgotten more than I have ever known! Graham helped us to build equipment that could handle the power needed for photo restoration and was instrumental in helping develop our remote tele-radiology unit (we were able to transmit x-rays and scans over the phone!).

The work I was doing with photo restoration was profiled on television in the “Beyond 2000” series that was popular at the time. This and a number of newspaper and magazine articles about the system I had developed catapulted the concept into a commercial reality.

It was about this time that I received an order for a computer from Ken Holmes, a systems manager with a fulfilment company in Panmure. I supplied the computer then received a call from him seeking help in getting it working. I went out that Saturday morning, with my daughter, Helen, in hand and proceeded to get it all working.



My good friend and super-technician, Graham Fletcher



More of Beyond Imagination

We got chatting about what I was doing with photo restoration and my other activities and he expressed some interest in being involved. I had no idea at the time that Ken was the well-known TV personality Paul Holmes' brother.

Ken made the decision to be an investor and active part of the Photo Restoration business. He and I would eventually take this business worldwide and it would become the largest photo restoration business on the planet.



Ken Holmes

Photoshop had just arrived on the market and I snapped up a copy and started to develop unique macros (program coding for sequential steps of activity) that provided restoration shortcuts and applications to achieve certain restoration effects. In short time I had a suite of macros which would become the foundation of the business. At this early stage in computer technology the hardware was underpowered and the software demanded great power. It was often frustratingly slow or did not perform at all or freezing when you were at a critical point in the work.

We used a very expensive dye-sublimation printer to print photo-realistic images after the restoration had been completed. These printers were \$18,000 each, extremely heavy and used expensive celluloid colour transfer cartridges. I purchased the printers from Kodak, the manufacturer. It wasn't too long before I got a call from the manager at Kodak, Doug Dickson, who was curious to know why a contact lens company was buying so many expensive dye-sup printers. Doug took a great deal of interest in our operation.

Slowly we started to offer the service to photo stores around the country and to various photo clubs and close contacts and we began receiving a small number of orders. We cut our teeth on these early images and I was quickly developing new macros to deal with specific image conditions.

A couple of years after buying the building we decided that it was too large for our purposes and we wanted to release some capital so we made the decision to sell the building and relocate the business. We moved both the laboratory and Beyond Imagination to Wairau Road on the North Shore. The lab was re-established at one end of the building, Beyond at the other. John more or less took control of the lens manufacture and I took care of Beyond Imagination although we shared responsibilities and supported each other strongly.

Around this time, I decide to re-engage with my high school with a view to giving back for the education I had received when I was a pupil. Selwyn College were keen to develop an initiative around the emerging technologies of audio and visual sciences and provide for the students a facility to further their studies of business and these AV principles.

I offered to mentor and support a major initiative involving a select group of students, some highly-motivated teachers including Louise Parker and Kate Janes (who, 27 years later, is still teaching at Selwyn) and our company with a view to building a new Audio-Visual centre in the college. The initiative was called Project Imagination.

The project was called CAVE (Centre for Audio Visual Enterprise) and we developed a business plan. This involved me teaching the students in the project team all aspects of running a business, researching and planning, the mechanics of funding and how to effectively communicate their ideas.

This was a milestone event for the students and helped them all to shape the future of their careers. A significant presentation was made to the Board of Trustees, College management, teachers and parents and was very well received. I am indebted to the many colleagues, friends, business associates and others that contributed to the project.

News of this project spread very rapidly and I was soon contacted by Mr Cliff Edmeades, Principal of Rutherford High School who invited me to establish a similar project in his school.



Project Imagination



presents

The C.A.V.E.

a multi-media proposal for
a multi-media studio

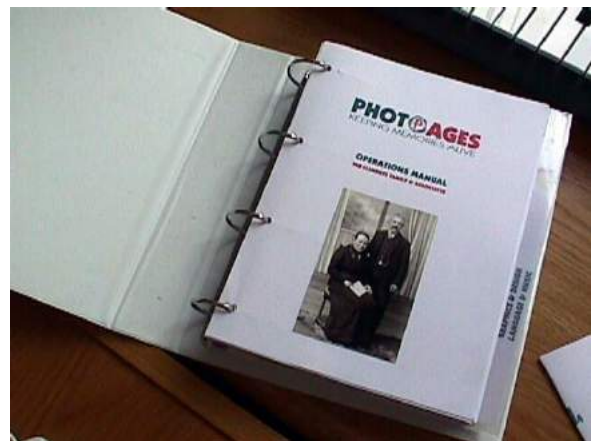

Swallowfield - our building, Ken and some of our team and the Photopages Franchise manuals I wrote

I still had a number of good contacts in the UK from my time in optics, especially owners of some contact lens laboratories. In a social conversation with one of them over the phone we started to discuss the work I was doing with photo restoration. They decided that they would like to do the same in the UK and perhaps we could work together to establish the service over there. Ken, John and I thought that it might be a great opportunity so Ken and I decided to fly up to the UK and set up business.

We had virtually no money, a couple of credit cards and a lot of hope. I arranged for us to stay with a neighbour in my old village, Chalgrove. Gordon and his wife, Patricia, provided Ken and I with a small room and two single beds. Gordon was a heavy smoker and enjoyed a drink or two – it was not ideal accommodation but we accepted it for what it was. We spent the next 4 months in the UK trying to establish the business. It soon became apparent that we should franchise the system – so I sat down and wrote two huge franchise manuals (over 800 pages) and Ken and I visited many of my old contacts and a number of new ones. By the time we were about to go home we had established 6 franchises in the UK. It was very hard work, especially given the fact we had little or no money and the credit card debt was getting scary.



Gordon Fryer

Ken needed to find alternative accommodation as it was becoming uncomfortable for him at Gordon's house and he lucked upon a lovely couple in Goring, Berkshire. They have become life-long friends. We set up an office in Swallowfield, Berkshire (a little south of Reading) and employed a couple of people to help grow and support the enterprise.



Goring, Berkshire

When we returned to New Zealand, I approached Trade NZ (Trade and Enterprise) to see if we could get their assistance in supporting the UK operation and to see if we could secure some funding to grow the business. This was a major turning point in our luck. They agreed and moreover gave us access to an FRST (Foundation for Research Science and Technology) grant. We applied and were awarded a substantial grant to help us build the business.



Photopages franchisees



Trevor Willmot

With this we established a number of NZ franchisees which, as it turned out was a hugely difficult task. I would never recommend to anyone to run a franchise! My friend and neighbour, Trevor Willmot, stepped in and took over running the business while we made the decision to return to the UK. Mere words cannot convey how much I appreciated Trevor's commitment to running things while I was gone. It was a hugely difficult task which he handled brilliantly, albeit he felt he was way out of his depth. A good man!

It takes an enormous amount of courage and fortitude to step into the shoes of another man's enterprise. Trevor is a man who enjoys the challenge of technology, a self-confessed "bodger" and a man of many skills. He has been a terrific friend and has provided me with wisdom and sensible advice. His family are supportive of each other and they all go out of their way to ensure that guests are made to feel welcome.

Trevor is an expert in purchasing, fulfilment and product management. He operates a boutique business in engine supplements and fuel additives along with a range of other specialist products.

We returned to the UK and were hosted at Westminster by Lord Newton at a function to support our entry to the UK market. It was while in the UK we discovered the name “Photopages” for the business. It was the result of a darts match at the “Red Lion” pub in Chalgrove – each of us threw a dart, scored it on the blackboard and had to write an idea for a business name next to the score. After 30 or so throws I wrote “Photopages” with the “Photo” part fairly obvious and the “Pages” part to represent both the paper on which they were printed and the “page” at a wedding at your beck and call. We all agreed to go ahead with the name.

After another 8-week stint in England we returned to NZ only to find that the lens business was declining fast and the technology business was suffering from lack of resources. We made the huge decision to sell the contact lens business and try and keep Beyond Imagination running. John decided to go with the lab and work as the manager for the new owners, I decided to stay with the technology group and run it with Ken. For me and John it was a sad parting but we remained good friends and colleagues.

Ken and I were now in a seriously difficult position. We had no money, very large credit card debt, no prospective customers, it was a couple of weeks before Christmas, a bleak set of accounts with no sales – it was absolutely the lowest point in my working career. We had sacrificed everything to advance the photo restoration business. I will forever be amazed and humbled by Ken’s steadfastness to stand alongside me and work to pull the business out of the fire.

We were living off the smell of an oily rag – the only household income was from my work at the theatre and music teaching, Jocelyn wasn’t working a paying job because she was being the mother for our children and Ken and I could not pay ourselves. We still had the rent to pay on the premises and all the other incidental costs of keeping the business alive.

It was the week before Christmas when Ken and I had almost given up when I said to Ken, “do you know anyone that might be able to help?” He contacted a guy called Barry Fraser who came in to see us – an eccentric fellow who admitted to us that he could not help us financially but he did know someone that might be interested. He introduced us to Alistair Ward who came in to meet us 2 days before Christmas. I showed him the technology behind what we were doing with photos and we let him know, warts and all, the position we now found ourselves. I expanded on all of the various initiatives we had in the pipeline – he suggested that we should stick to our knitting and concentrate on the restoration service. He was curiously interested in the operation and said that he could introduce us to an angel investor, Chris Due.



*Alistair Ward (above)
Chris Due below*



215 Wairau Road (above) - The first Photopages studio (below)



Chris came in on Christmas Eve, spent some time learning what we had and made an offer to invest in the business. We were very relieved. Hanging by a thread, we now had an opportunity to get this service to market and save our bacon.

Chris did invest in tranches and became our fourth shareholder. Alistair also invested and became our fifth. Our third investor was already on board – Ross Stanley. I met Ross on board a flight to Sydney. He was sitting next to me on the flight and we got chatting about life and business. I told him what we were doing and he said, “I’d like to invest in that!” so when we got back to Auckland, Ross came on board as a shareholder. We are still very close friends to this day – he and I regularly play cribbage together!

With the new shareholders on board and some capital to help grow the business we began by moving down stairs in Wairau Road (less expensive rent, but slightly more room) and we hired Lisa Holmes to be our first restorer. We set up 5 workstations and began actively growing our presence in the market. We also hired Doug Dickson (he was the Kodak manager who wondered why we were using so many dye-sub printers). Doug was completing his career with Kodak and we were grateful that he accepted our rather humble offer to join the team. Doug also became a shareholder of the company.

We used a clever computer technician, Ryan Smith, to help us set up the new facility and we were looking for some type of desk to support the double-screen (they were huge and heavy 23” CRT screens) workstations. Ryan introduced us to his close relative, Murray Russell who was both a programmer and small-time furniture maker. Murray designed and built the workstation benches for the new facility.



Photopages first studio - downstairs at Wairau Road, Glenfield



*Prime Minister Helen Clark opened our new Photopages studio –
From left to right - Lisa Holmes (our first digital artist), Rt Hon Helen Clark PM and Ken Holmes*

The huge turning point for us happened late in 2001. Trade NZ were hosting three extremely wealthy business entrepreneurs and investors from the United States, Ed Bernstein, Arun Aruba and Joe Abrams. They were here in New Zealand to determine whether there was an opportunity for them to invest in Kiwi innovation. The agenda for the visitors was to meet with the top ten New Zealand businesses – we were certainly not in that league – a five-person enterprise operating from a small basement office.

I received a call at about 10:00am from our Trade NZ Account manager, Dominic Cavanagh, who asked, "Are you able to show your photo system to three US-based investors later this morning?" (it seems they had about 30 minutes' spare between two other venues and Trade NZ just needed to fill the time gap).

I said, "Absolutely, of course!" We scrambled to clean the place up and prepared the facility to host them. They duly arrived and in around 20 minutes I demonstrated what we could do to photos, a little about the ideas for marketing the service and how we believed that the idea was a unique approach for photo retailers. They all sat and watched without saying a word, thanked us politely, and left. I assumed that we had failed the test!

At 11:00pm on Sunday night that week, while I was working on an urgent restoration, I received a one-line email – “We have an immediate interest in your system, please contact me, Ed”. I quickly realised that it was not from Mr Ed, the talking horse but almost certainly was from Ed Bernstein. I immediately phoned Dominic Cavanagh (who was a little miffed that I had called so late on Sunday night) and asked if he could let me know where Ed Bernstein might be and what was his phone number. Dominic told me that he and his wife were staying at the “Wilderness Lodge” at Lake Moeraki in the South Island. I immediately phoned Ed at the lodge. He thanked me for calling saying that he had expected that I might call and went on to say that he was extremely interested in taking our service right across North America. He suggested that we meet at Auckland Airport the following day before he flew back to the USA.

We met over a coffee and using paper table napkins we scribbled out the basis of a deal to launch our photo restoration service in the USA and Canada. Ed promised to communicate more fully on his return to the USA and would send us a contract to consider based on our discussions over coffee. I admit that I left the airport never expecting to hear from Ed again. It all seemed too good to believe!

Ed kept his promise and we soon had a contract in front of us to consider. The contract even had non-performance clauses by them – if they did not deliver on their side of the agreement, then they would pay us penalty payments! We signed the deal and the Press went crazy announcing the success:



Ed Bernstein

Money, jobs from old memories

A taste for nostalgia and restoring old memories will soon be funding 100 new jobs and millions of dollars in overseas earnings for a small Auckland company.

Glenfield firm Photopages Global, which employs five people, specialises in the digital restoration of old damaged photos.

Thanks to the deep pockets and enthusiasm of three US-based venture capitalists, the Photopages name will soon be seen in photo shops and stores across North America.

In a deal announced yesterday by Trade New Zealand, consumers will soon be able take their old photos into any one of thousands of agents across Canada and the United States.

They will then be digitally scanned, sent to New Zealand's Photopage lab, where they will be restored using software developed by company founder and owner Ian Handricks.

This software automates a lot of the procedures normally done on old photos. Once restored, the picture is electronically sent back to the Photopage agent, where it is printed out onto photographic paper and given back to the customer.

Handricks said there was a growing gap in the photographic market "in the middle" between film-based photography and advanced digital methods.

Digital restoration of old printed photographs was one way of bridging this gap. Photo restoration in North America was something of a craft industry, with some operators taking weeks or months to do the job.

Photopages promised an overnight service at a fixed price. It could colourise black and white photos and restore seriously damaged pictures that other operators could not.

Once the deal swings into operation, work volumes at Photopages are predicted to increase from the 25-30 photos being restored each day to several thousand.

Handricks said the whole market of giving restored photos as presents

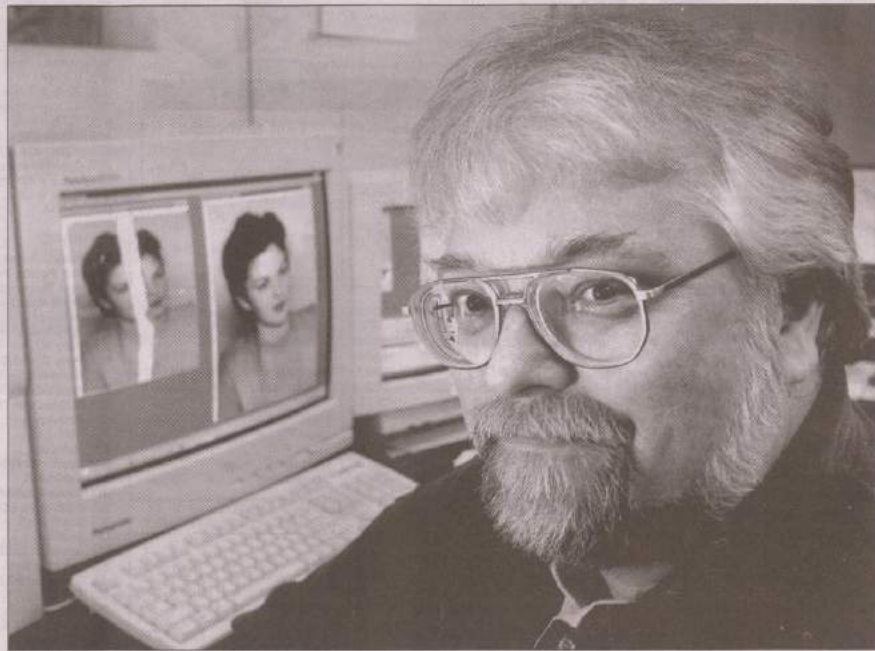

OLD AND NEW: Ian Handricks with the software he designed for photo restoration, which has been taken up by an American company, creating jobs here.

PICTURE / MARTIN SYKES

was lying untapped in North America and Europe.

The deal has been structured so Handricks keeps all the intellectual property rights covering the software and technology used in the photo restoration business.

As well as money, the US backers brought marketing and advertising expertise that would soon be taking the Photopages name to Europe as well.

Trade New Zealand said it had

been working with PGL for the past two years, helping it to set up in Australia and the UK.

Account manager Dominic Cavanagh said Trade NZ brought an American IT journalist to New Zealand last year, showing him several local IT firms.

This journalist "who became quite evangelical about what he saw" according to Trade NZ, then introduced Investment New Zealand, the Government's investment promotion

agency, to US investor Ed Bernstein, who then flew over here, met Handricks, and decided to invest.

Neither Trade NZ nor Handricks will say how much money is being invested by Bernstein and two other investors, though they stressed that advertising, marketing and distribution skills were being provided by the US investors.

The deal with Photopage is a five-year arrangement, with a 10-year renewal provision.

Money, Jobs from Old Memories

Auckland company signs deal with US investors

"A taste for nostalgia and restoring old memories will soon be funding 100 new jobs and millions of dollars in overseas earnings for a small Auckland company. Glenfield firm Photopages Global, which employs five people, specialises in the digital restoration of old damaged photos.

Thanks to the deep pockets and enthusiasm of three US-based venture capitalists, the Photopages name will soon be seen in photo shops and stores across North America.

In a deal announced yesterday by Trade New Zealand, consumers will soon be able take their old photos into any one of thousands of agents across Canada and the United States. They will then be digitally scanned, sent to New Zealand's Photopages lab, where they will be restored using software developed by company founder and owner Ian Handricks.

This software automates a lot of the procedures normally done on old photos. Once restored, the picture is electronically sent back to the Photopages agent, where it is printed out onto photographic paper and given back to the customer. " Handricks said there was a growing gap in the photographic market "in the middle" between film-based photography and advanced digital methods.

Digital restoration of old printed photographs was one way of bridging this gap. Photo restoration in North America was something of a craft industry, with some operators taking weeks or months to do the job. Photopages promised an overnight service at a fixed price. It could colourise black and white photos and restore seriously damaged pictures that other operators could not.

Once the deal swings into operation, work volumes at Photopages are predicted to increase from the 25-30 photos being restored each day to several thousand. Handricks said the whole market of giving restored photos as presents was lying untapped in North America and Europe.

The deal has been structured so Handricks keeps all the intellectual property rights covering the software and technology used in the photo restoration business. As well as money, the US backers brought marketing and advertising expertise that would soon be taking the Photopages name to Europe as well.

Trade New Zealand said it had been working with PGL for the past two years, helping it to set up in Australia and the UK. Account manager Dominic Cavanagh said Trade NZ brought an American IT journalist to New Zealand last year, showing him several local IT firms.

This journalist "who became quite evangelical about what he saw" according to Trade NZ, then introduced Investment New Zealand, the Government's investment promotion agency, to US investor Ed Bernstein, who then flew over here, met Handricks, and decided to invest.

Neither Trade NZ nor Handricks will say how much money is being invested by Bernstein and two other investors, though they stressed that advertising, marketing and distribution skills were being provided by the US investors. The deal with Photopages is a five-year arrangement, with a 10-year renewal provision."

Ed Bernstein was true to his word and we soon began receiving not hundreds of photos but thousands of photos daily. We were seriously underpowered to handle the numbers of images arriving. We had just five restorers who, even with best efforts, could not cope with the exponential growth.



Photos were arriving by the thousands ...



... within days, tens of thousands of restorations were being processed ...



With the contract in our pocket, I went in search of some more investors to raise capital to build a new large facility. I raised many tens of thousands of dollars and we built a new facility above Harvey Norman's flagship store in Wairau Park. It was a huge room and we arranged for Murray Russell to build many new desks, Ryan Smith to build and install a mega server to handle the volume and we purchased many new workstations.



Part of the new facility for Photopages in Wairau Park, Glenfield

We knew we would have to run the facility 24 hours a day, seven days a week and we needed a lot of technicians to man the three shifts. Finding people proved to be a nightmare. We simply could not find, let alone employ, the numbers of operators that we required. We approached universities, tech institutes and art schools in the hope of locating operators and we learned of an art and design school based in New Plymouth, but In the end we had a breakthrough - we managed to hire most of the team from Unitec in Auckland. Training now became the issue – how do we train so many new operators at once and in time to handle the ever increasing numbers of images arriving from North America.

In the end, I fast-tracked the learning and sat down and developed many new macros to speed and simplify the processes. Ken and Doug took control of staff and process management and I concentrated on developing and optimising the system, training and attracting investors. We were fortunate that Ed paid us in full and on time and we never experienced financial issues between the two companies.



Above: Our restoration team at Wairau Park, Glenfield and below at work restoring images



I made a trip to the US to meet with Ed, who was a gracious host and together we looked into new ways of using photos to excite retail growth. It was during this visit that Ed showed me a range of ideas – photos on playing cards, containers, T-shirts and many other ideas. This was the start of some additional services which today is now commonplace. Ed had by now been running a nationwide television campaign to boost sales and had successfully signed on Walgreens, Walmart, CVS, Albertsons, Best Buy and a host of other giant retail chains to our service. In New Zealand we successfully negotiated with Kodak to provide photo-restoration services to their chain of outlets in NZ and also completed the same arrangement with Fuji.

We employed a young Indian, Kaushal, a married man from Ahmedabad in Gujarat, India. Kaushal had been sent to NZ by his father to learn business and then return to take a position of responsibility with the family business. Kaushal responded to one of our adverts we ran for staff. At the first interview Doug offered him a role but he said he was unable to accept because he had made a commitment to support the owner of the BP service station for 3 months and needed to complete that commitment. Based on that response alone Doug told him that if he ever wanted a position with us that he would be first in the line. To his credit when the 3 months was up he made contact and Doug hired him. Kaushal was the only staff member to achieve the daily production numbers we were requiring per operator for some time.



Doug and Kaushal

Our workload was growing fast and one morning Kaushal walked into Doug's office and said, "I am returning to India. I would like to set up a restoration facility in India to handle the excess of work we were receiving". To Doug's credit and on a handshake, a deal was struck with Kaushal that he would open our first satellite operation in Ahmedabad. This he did and he kept his word to be our second operation. He is now a very successful businessman in India and employs hundreds of people. He considers us family and in particular, Doug who he considers is his honorary grandfather! Doug is still in business with Kaushal and his brother, Kandeep.



Part of our large Indian Studio



Kaushal with some of his team



Our Photopages Studio in Shanghai, China



Beginning the build of the photo restoration facility in Shanghai



The Shanghai restoration team





Above: Our Japan Office in Tokyo and below: Just signed our first major retail agreement in Tokyo



Not too soon after this we established a distribution network in Japan, I flew to Japan to establish the service there and afterwards flew to Shanghai, China to build a third production unit. Our volumes of images were growing rapidly and we simply could not cope even with India's help. The New Zealand operation was shaky – it was difficult to find operators and the night shifts were goofing around due to lack of supervision.

Establishing Shanghai was an exercise in frustration. Firstly, to run a business there you require a business licence (difficult to get and expensive), secondly the internet is heavily censored (especially with the transmission of images) and thirdly workmanship is shoddy and good tradesmen are hard to find (slow and expensive). Eventually, we had another operation running – 20 workstations and we flew a couple of our technicians up to manage and train the operators.

The Japanese distributor was owned by Jonathan Hendriksen. He was keen to become involved in our company in New Zealand and made an overture to become an investor and shareholder. At first this seemed to be an attractive proposition and we voted to sell down a part of the company to them. Jonathan came onto our Board and began a series of endeavours that eventuated in him taking over the company and we as founders of the organisation being bought out.



Jonathan Hendriksen

Ken was first to go and got paid out for his current account and shareholding and I was last to leave receiving nothing. Some creative accounting had been applied to my current account turning it from a credit to a debt. I left with nothing and no job and no interest was shown by the new owners in retaining my services. It was a bitter blow. At the same time, Ed had attracted investment from Disney in his company. Exactly the same happened to him (at almost the same time) he lost his company to a buy-out by Disney.

This also marked the end of my marriage. The stress and strains of the business, my frequent tours of duty overseas and growing tensions at home was not helping our relationship. Jocelyn had developed a relationship with someone else and it was becoming impossible to continue the marriage. We decided to split with Jocelyn moving to a new address and me continuing to occupy our family home with the children. Eventually the house was sold, mortgage repaid and the remaining assets split. I moved to a 4-bedroom home in Albany and the children alternated between us both.

So here I was. No job, no business, no marriage and no prospects. A very miserable time, but I knew I had to pick myself up and start again. I set up a workstation at home and in 2003, I began work on Tooth-pix, a professional imaging service providing a comprehensive yet simple method for dental photos to be altered to show predictive outcomes for cosmetic surgery. I pioneered the manipulation software and techniques for Tooth-pix and has worked closely with key dentists in NZ (one of whom was Ed Alcock, a dentist I had first met way back in 1974 in the stairwell of 9 High Street when he was visiting Hirst's dental lab!) to develop a professional on-line interface for all dentistry. Doug, I and my good friends Brett Howes & Melisa Perkin set up Photo Illusions Ltd at a meeting in Opito Bay and we started the new venture developing web sites and some photo restoration and doing whatever we could to make a dollar. Toothpix, Acres & Realty Pix were all developed during this time.



In 2004 saw the release of my unique real estate system, Realty-Pix. Similar to Tooth-pix, it provided the opportunity for property buyers to explore the potential of a property prior to investment, encouragement for vendors to better prepare the property for sale and can inexpensively explore make-over options when considering planned home improvements. I worked closely with key people within the real estate industry to advance the use of more effective marketing techniques.



CS2 workshop

DENTAL PROFESSIONALS
Dr Gerard Kugel
Adobe Photoshop CS2 workshop

Search

Login
Member:
Password:

Adobe Photoshop CS2 workshop

Cosmetic Dentistry with Adobe Photoshop CS2

AUCKLAND & WELLINGTON

After implementing digital photography into your daily dental practice, one of the natural progressions is the cosmetic simulation - combining the versatility of the digital medium, with the power of Adobe Photoshop CS2 and, of course, your own sound clinical judgement - to create a simulated "after" photo from a "before" photo. Mr Handricks is possibly one of the world's most qualified individuals to teach you how to do this. His company, Photo Wonder, uses the Photoshop software to work on millions of photos per week, utilising many techniques which he devised. Using simple, easy to learn and use techniques, participants will learn how to simulate cosmetic dental procedures such as the restoration of missing teeth with implants or bridges, tooth whitening, restoring broken or worn teeth, gingival recontouring, etc.

Here are what some previous participants have said about this course:-

"For me, hands on has always been the best way to learn, and Ian not only made it easy, but interesting, informative and fun. The day went too quick! Photoshop is a big daunting programme but with Ian's expert knowledge it became a breeze to reshape, recolour and repair teeth. I look forwards to using this knowledge to improve the quality of my surgery photos and personal photos, and to restore damaged old photos." - Dr H.Stephen

"Ian Handricks was a great teacher, extremely knowledgable and positive. He was very helpful and approachable. His techniques were very useful and far more simple and quick than any photoshop dental course I have attended before. Also, all the added extras were great, like the 3 photos he restored for me and his tips on genealogy. What an interesting man!" - Dr A.McKeefry

"Simulating potential results for cosmetic cases has never been so easy and the ability to fix my holiday pics was a huge bonus! This course was worth every penny!" - Dr B.Yang

Participants will need to bring their own computer to the workshop but everything else including a working copy of the software will be provided for the day.

Course Details

Approved for NZDA CE credits

Registration - 8:30am. Start 9:00am. Lunch 12:30pm-1:30pm. Finish: 5pm.

Cost: \$1000 incl GST. 20% discount for NZACD members. Course fee includes morning tea, lunch and afternoon tea.

Wednesday, 6th September 2006 (Pre-NZDA Conference)
Crowne Plaza Hotel
128 Albert St
Auckland

Saturday, 23rd October 2006
Venue TBA
Wellington

Course Registration

To register for this course, please fill in the registration form and send back to us by mail or fax

To obtain a registration form:-

- (1) Find one which we have already sent to you in the mail
- (2) Click [here](#) to download the registration form in pdf format
- (3) Email course convenor, Dr Roger Tiang, at secretary@nzacd.co.nz and ask for a form to be sent to you
- (4) Call 0800 NEWSMILE (0800 638 764) and ask for a form to be sent to you

Otherwise, for all enquiries please email secretary@nzacd.co.nz

I also ran workshops for dentists on using Photoshop in cosmetic dentistry – I wrote a number of unique procedures in PS Macros to make the manipulation of Orthodontia Photographs possible to show the outcomes from cosmetic procedures

I also set up a small business offering photo restoration and genealogy services - firstly out of my friend Albert Neilson's picture framing shop in Mairangi Bay and then out of a large Scrapbooking warehouse store in Glenfield. It was here that I met Adrian Clarke, a talented and expert salesman who at that time was running a printing and binding business perfectly suited for my genealogy books. He and I have remained close friends and business associates.



Ken Holmes - Authorised Financial Adviser

Ken had now decided to become an Insurance adviser and set up business in his garage and worked hard to become qualified as an AFA (Authorised Financial Adviser). He and I remained close friends and he asked me to help him devise a method of producing SOA's (Statements of Advice) and methods to book appointments and manage data. We met early each morning and developed a seriously effective system to accomplish what was required. It was so successful that in no time Ken's business had grown very large and he was winning awards for top performance.

With the success we were having with the system, Ken suggested that we should develop an Insurance adviser database system that could automate the functions we had created. We also decided to call the system "Kenny"

I masterminded a huge flowchart and designed a system specification for "Kenny" and we engaged the services of Murray Russell (bench maker/programmer) to write the code. This turned out to be a very long process interrupted by periods when Murray was unavailable and in the end the cost of deploying Murray to write the code made the venture untenable. After installing a dozen or so systems we were forced to abandon the project.



317 Albany Highway, Albany, Auckland - My home after separation from Jocelyn



Me and Melissa

After moving to Albany I struck up a friendship with a lawyer, Melissa Perkin. Always as just friends we used to meet at each other's home for a meal, watch a movie or two. Melissa is a smart and intelligent woman who has established herself as an exceptional businesswoman. She suggested one day that I might consider moving to her home as a flatmate. It seemed to be a sensible arrangement so it happened. I was her flatmate for the next 9 years and we enjoyed many wonderful evenings around the dining table with friends and got to share a lot of sightseeing around the country.

By now, I was providing support services to a large number of advisers and through some contacts in the industry, set up a new services enterprise we called "The Hub". By this time, I had learned to design and write websites and with this knowledge set about creating an interactive site for "The Hub". "The Hub" caught on for a while, but became too difficult to resource and we decided to fold.



Through the activity with "Realty-Pix" and the work I had done with insurance support services, a unique set of circumstantial events happened.

Over a meal with business associates, one of whom was a lawyer, we discussed the recent law change that now allowed lawyers to convey property. The discussion went on late into the evening towards the possibility of creating a dedicated conveyancing system especially designed for lawyers to use. I proposed a concept called "ACRES" (A Complete Real Estate System) and we formed a small working group to spearhead its development. I wrote a complete specification and the system was launched. It is still in operation today.



I grew up with little or no knowledge of the origins of my family and in particular no knowledge of the origin of my surname. When I was 16 I had this sudden urge to find out more about the family. I visited my grandmother and had long chats about what she could remember, did the same with all the living relatives that I could contact and the slowly pieced together a rudimentary family tree chart. This activity soon became an obsession! The tree chart grew in size and I soon realised that I had to find a new method of recording data.

This was the start of a lifelong interest in genealogy which I have now turned into a boutique business. I have researched and written hundreds of family books for many clients over the years. The books are hefty 500+ page volumes full of stories, family history and photos. I now have an enormous database and thousands of resources that lets me discover and uncover the background for most families that I'm researching.

From Shorelines Magazine 1st Oct 2020

A Time-Travelling Scavenger Hunt: The Fascinating World of Genealogy

As human beings, we have a natural curiosity about who we are, where we come from, and why we have particular abilities or think a certain way. Bays resident Ian Handricks understands this yearning for insights. Intrigued by his own unusual surname (forbears.io states there are approximately only 157 people in the world called Handricks), he started asking questions of his paternal grandmother. A vibrant, smart and funny lady who lived to be 105, Ian spent the last nine years of her life digging into the origins of their family. What he uncovered was nothing short of jaw-dropping!

He traced his lineage back to the late 1700s and the French Revolution. Three Jewish brothers bore the name Turfkruijer (from the Russian meaning grass cutter). Levi, Mordecai and Moses made their way to Paris from the Ural Mountains, and took up the macabre job of holding auctions in the street for the severed heads of executed nobility. This earned them the nickname Hangjas (hang head in English). Things turned ugly when an angry mob attacked the brothers, murdering two of them. Levi fled to Haalem in The Netherlands, where he was sheltered by relatives. To protect his identity, he adopted Hangjas as his surname, and travelled to Australia where it seems the immigration officers misheard the name and wrote down Handricks. Levi was Ian's great-great-great grandfather.

Whilst undoubtedly remarkable, Ian says that these kinds of revelations are not unusual. Inspired by his personal voyage of historical discovery, he has been helping people to trace their ancestors for more than 40 years now, and is absolutely of the opinion that every single family has an amazing tale to tell or secret to unearth. Indeed, seeing people's reactions when these stories come to light remains his biggest motivator.

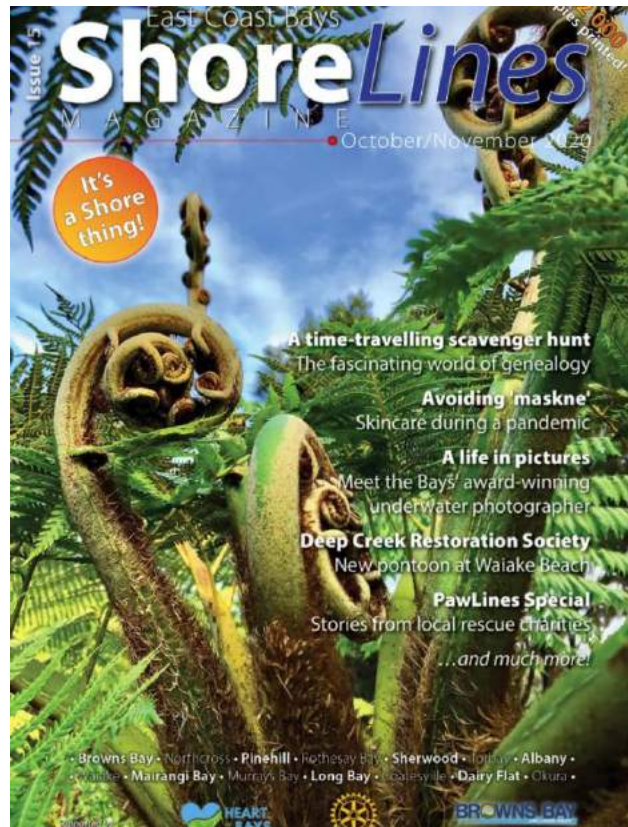

Ian's own research revealed that he is descended from theatrical, artistic, entrepreneurial types, and, as a result, he says he understands himself better. His clients have also felt these benefits. For example, a few years ago, Ian met an elderly gentleman while out shopping. "He looked as though he'd had a hell of a life," Ian recalls. "He was miserable-looking, downtrodden, and told me how unhappy he was in his marriage. His wife came over to where we were sitting, and she looked equally despondent. So, I just told them, 'I'm going to do your family trees. No arguments.' Well, that changed everything! Through my conversations with them, amongst other things, it turned out they'd both had terribly hard lives before they met, and yet they'd never told each other about this and were silently carrying these emotional burdens." Having completed his work on their ancestries, Ian saw the couple again a little while later. "They walked towards me, holding hands and, at 78 years of age, they told me they were enjoying their second honeymoon," he smiles.

Others of Ian's clients have enjoyed a genuine confidence boost. "One 80-year-old lady was leading a fairly pedestrian lifestyle. When she found out that she'd had some seriously go-getter women in her family, it emboldened her. She's now a driven publisher, highly proficient on a computer, and with a real purpose."

Not surprisingly, Ian loves his work! He takes a collaborative approach, and sometimes spends whole weekends with a client, eating picnic food, listening to music, and together learning the secrets of the archives.

He goes into extraordinary detail with his research. The privately published Generations books can be hundreds of pages and include numerous visuals, such as vintage photographs, newspaper clippings, travel records, and life-moment certificates. "Many projects are so large that the information fills more than one volume. Some

families we've been contracted to research and publish have resulted in three to seven volume sets of books – that's more than 1.5 million words, 2,500 pages or more, and upwards of 3,000 photos and document images! These become significant heirlooms and now feature prominently on the living room table or take pride of place on the family bookshelf."

A Time-Travelling Scavenger Hunt: The Fascinating World of Genealogy

As human beings, we have a natural curiosity about who we are, where we come from, and why we have particular abilities or think a certain way.

Rays resident Ian Handricks understands this yearning for insights. Intrigued by his own unusual surname (forbeso states there are approximately only 157 people in the world called Handricks), he started asking questions of his paternal grandmother. A vibrant, smart and funny lady who lived to be 107, Ian spent the last nine years of her life digging into the origins of their family. What he uncovered was nothing short of jaw-dropping!

He traced his lineage back to the late 1700s and the French Revolution. Three Jewish brothers bore the name Turfrazier (from the Russian meaning grass cutter). Levi, Montecai and Moses made their way to Paris from the Ural Mountains, and took up the macabre job of holding auctions in the street for the severed heads of people executed by the guillotine. This earned them the nickname *Hangias* (meaning hang head). Things turned ugly when an angry mob attacked the brothers, murdering two of them. Levi fled to Haarlem in Holland, where he was sheltered by relatives. To protect his identity, he adopted Hangias as his surname and, when his son migrated to Australia, it seems the immigration officers misheard the name and wrote down Handricks. Levi was Ian's great-great-grandfather.



While undoubtedly remarkable, Ian says that these kinds of revelations are not unusual. Inspired by his personal voyage of historical discovery, he has been helping people to trace their ancestors for more than 40 years now, and is absolutely of the opinion that every single family has an amazing tale to tell or secret to unearth. Indeed, seeing people's reactions when these stories come to light remains his biggest motivator.

Ian's own research revealed that he is descended from theatrical, artistic, entrepreneurial types, and, as a result, he says he understands himself better. His clients have also felt these benefits. For example, a few years ago, Ian met an elderly gentleman while out shopping. "He looked as though he'd had a hell of a life," Ian recalls. "The man



miserable-looking, downtrodden, and told me how unhappy he was in his marriage. His wife came over to where we were sitting, and she looked equally despondent. So, I just told them, 'I'm going to do your family trees. No arguments.' Well, that changed everything! Through my conversations with them, amongst other things, it turned out they'd both had terribly hard lives before they met, and yet they'd never told each other about this and were identity carrying these emotional burdens." Having completed his work on their ancestors, Ian saw the couple again a little while later. "They walked towards me, holding hands and, at 78 years of age, they told me they were enjoying their second honeymoon," he smiles.

Others of Ian's clients have enjoyed a genuine confidence boost. "One 80-year-old lady was leading a fairly pedestrian lifestyle. When she found out that she'd had some seriously go-getter women in her family, it



emboldened her. She's now a driven publisher, highly proficient on a computer, and with a real purpose."

Not surprisingly, Ian loves his work! He takes a collaborative approach, and sometimes spends whole



Left: Joseph (Ian's immigration paper)

Right: Ian's grumpy grandmother, Ruby

weekends with a client, eating picnic food, listening to music, and together learning the secrets of the archives.

He goes into extraordinary detail with his research. The privately published *Generations* books can be hundreds of pages and include numerous visuals, such as vintage photographs, newspaper clippings, travel records, and life-moment certificates. "Many projects are so large that the information fills more than one volume. Some families we've been contracted to research and publish have resulted in three to seven volume sets of books – that's

Continued on pg 6

Recognising the joy and fascination that tracing ancestors can bring, Ian provides links to a wealth of free online resources on his website. These include general genealogy sites as well as those that focus on New Zealand, England and Ireland. There are registers of cemeteries and graves, photo archives, ship's registers, and newspaper archives.

He offers some simple advice: begin with what you know. Even if you don't have full names, precise locations or complete dates, pull together the fragments and follow the trail. Talk to your elderly relatives; ask them what they remember. What was the gossip about previous family members? Do they have any old photos or family certificates tucked away? These conversations could be a wonderful way to reconnect to another generation and help to keep family history alive.

Our editor writes: I can personally vouch for how illuminating even a brief time with Ian can be. While we were chatting for this article, and armed only with a couple of names, locations and approximate dates, he had efficiently traced my dad's father's family back several generations and revealed that I was related to one Captain William Money. He was a director of the East India Company and, apparently, a portrait of his sons hangs in the National Maritime Museum in Greenwich. Who knew?!

This spurred me into contacting my uncle and cousins, to see what they know about our family, and inspired conversations and connections which would not otherwise have happened. Perhaps in 2020 more than ever, I'm not sure you can put a price on rekindling those bonds. Thank you, Ian.



Inside some of the books I have researched, written and published

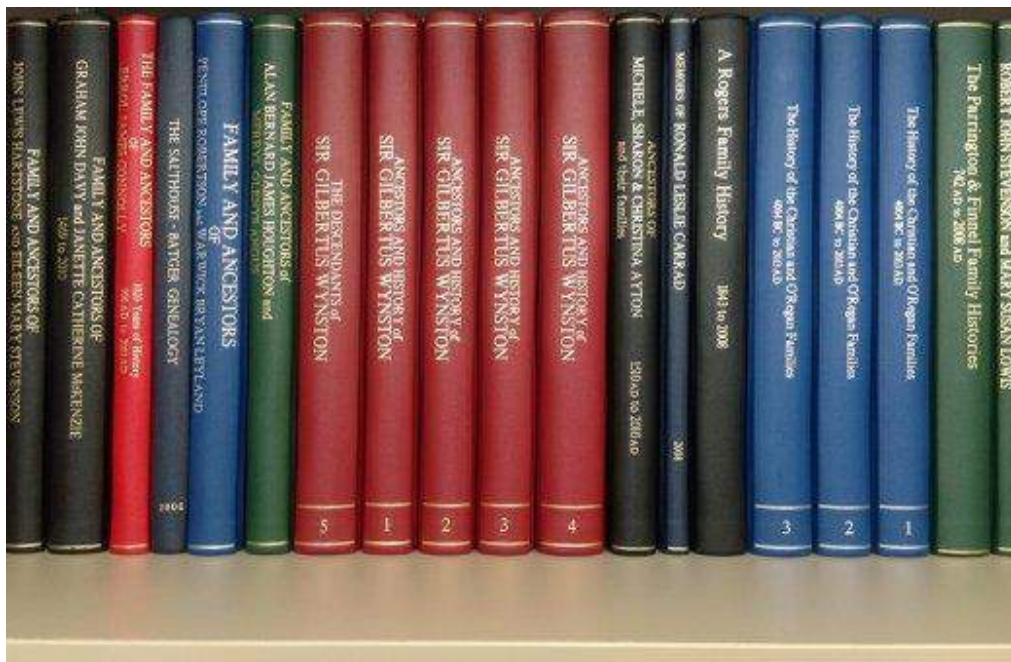

Just some of the more than 2,500 books I have research, written and published over the last 45 years

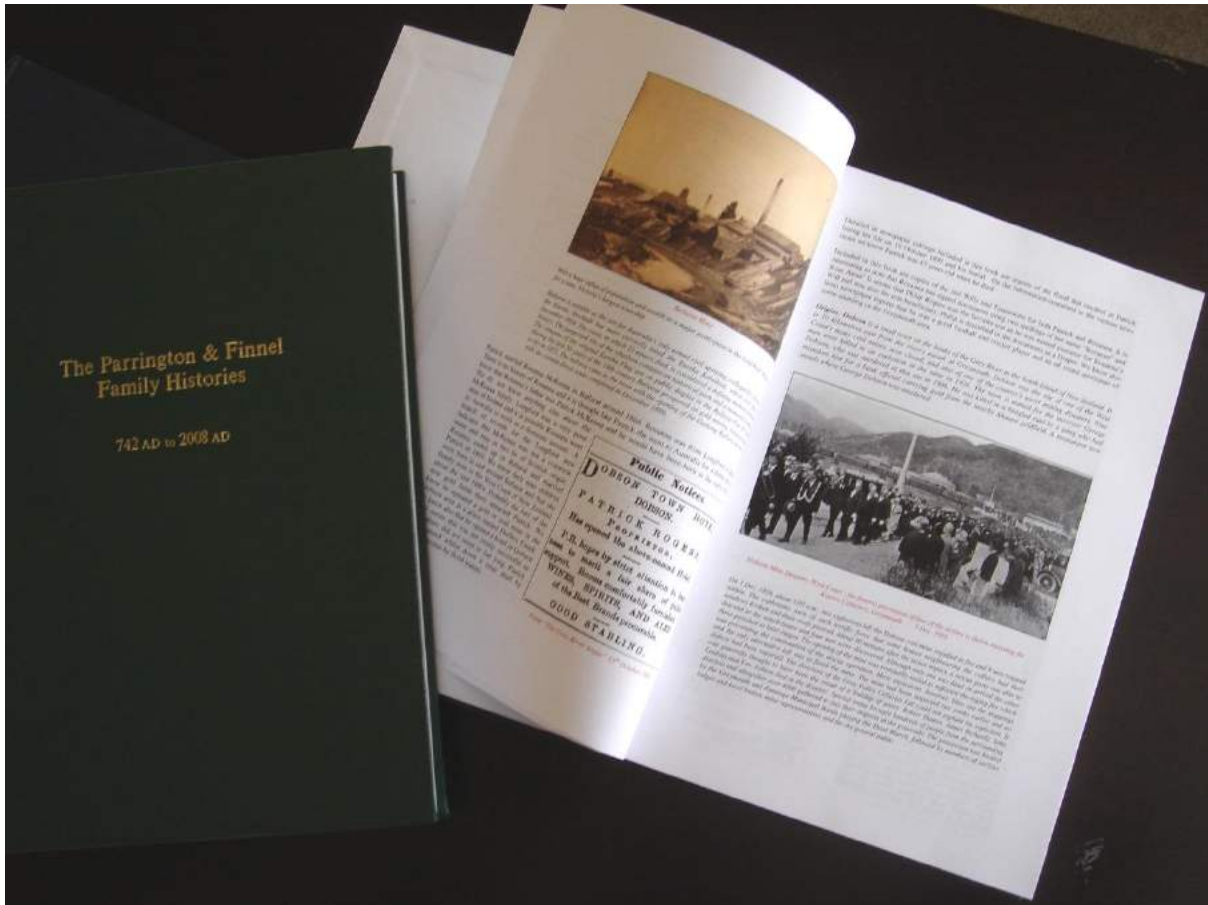

I research and publish many books on genealogy

It is perfect sister business to the photo restoration since each book has 500-1000 photos, most of which require restoring. I research, restore, write, edit and publish every book myself. They are all a significant undertaking and always appreciated by the recipients. I estimate that in the last 30 or so years I have written more than 200 million words and restored more than 300,000 photos and documents for the genealogy books!

After our marriage ended our children spent time living with both of us, however they were now in their late teens (16, 18 & 20) and progressively each of them decided to go flatting. Daniel had started a degree at Massey University but it wasn't panning out the way he had hoped so we offered him a job working in the photo restoration business as a computer technician. This lasted a bit over a year but he found it difficult to engage often arriving late and sometimes sleeping in the office overnight. He was having difficulty finding his feet. Doug had finally had enough and dismissed Daniel (Doug felt a bit worried about firing the boss' son but it was the trigger Daniel needed to get his life on track).

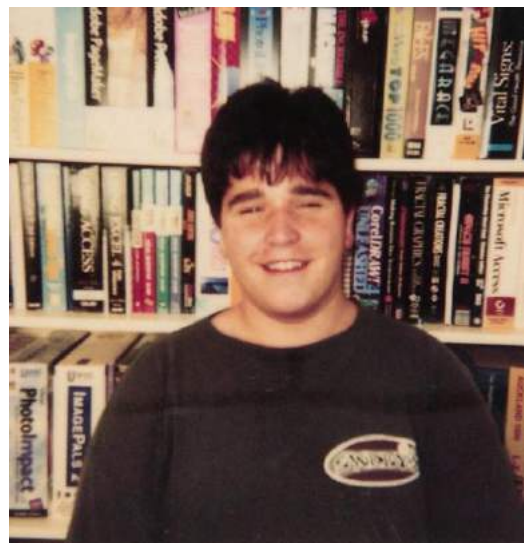



Daniel Logan Handricks



Young Daniel

Daniel soon found a job in technology with Telecom (now Spark) and he was in his element. He loved the work and they were delighted to have him on board. Daniel set himself up in a number of apartments mostly in and around Ponsonby, each one better than the previous, and always with his mates. It is important to note that Daniel was an exceptional cook and chef and was in his element in the kitchen. Everyone appreciated the fine dining afforded by his talents with food.



Daniel loved cooking

Daniel was also a very good (and daring) Bridge player, but the fact that he played at all is purely circumstantial. I used to play regularly at home with some friends and Daniel would hover in the background. I said to him one afternoon, “how about sitting down and having a game?” The response was an abrupt, “No!”. Noting his reply, my partner at the Bridge table got up and headed for the bathroom and told Daniel, “sit down and play my hand, please” – With a gruff he did so and proceeded to play like a grand master – we were all shocked as he had never had a lesson and all he knew about the game was watching over my shoulder. That week I took him with me to the toughest club in New Zealand, Akarana, and we promptly won the evening (mostly due to his play). The president of the club came over to our table and said to Daniel, “Who are you?”, at which he replied, “I’m that old fart’s son!” He was offered a position on the National Youth Team playing at the National Bridge Congress later that month. He played and he won!



Daniel Logan Handricks

Helen was dux at primary school, aged 13, 1996, and got to keep the fancy trophy for a whole year which was proudly displayed on the bookcase at home. She returned the following year to give a valedictory speech. When our marriage ended, Helen was starting her Bachelor of Business degree at Massey University. She had previously been enrolled at Auckland University studying towards an Arts degree majoring in Italian. The shift to business probably suited her more comfortably and she went onto graduate. After a short period of time living with me, with her mother and occasionally with friends, she made the decision to move to South Korea and teach English. Helen finally settled in Australia where she encouraged Daniel to also fly across and live there also. Daniel was not good with saving money and had built up a small number of debts. He decided to emigrate to Australia to join Helen securing a job with Telstra. Helen took over managing his finances until he was in a more stable financial position.



Helen with her award for being Dux

Éloïse also oscillated between me and her mother for a while until she moved into an apartment with her boyfriend of the time. She had secured a job with a marketing company and was enjoying her work. However, with the encouragement of Helen and Daniel, she too emigrated to Australia. Helen and Éloïse set up a web-based business selling clothing and fashions styled in the manner of the 1940's. Helen on returning from Korea established herself in a company promoting secondary and tertiary educational systems.

By 2016, Daniel was living with his girlfriend, Emma Land, at a new home at 40 Grant Ave, Hope Island, Gold Coast, Queensland, Australia. They were very close and happy together. I was so happy for them both. On Christmas Eve 2016, I received a phone call from Daniel – he said that he had had a sudden and terrible pain in his back. He continued by saying he'd seen a doctor who had advised him to go to the hospital to have a scan. Daniel informed me that the scan had shown that he had a large tumor in his bowel and that they would need to operate sometime to remove it. I was naturally seriously worried. A couple of hours later I received another call from him. He was being prepped for an immediate operation. It seemed that with his condition they could not wait.



Emma and Daniel

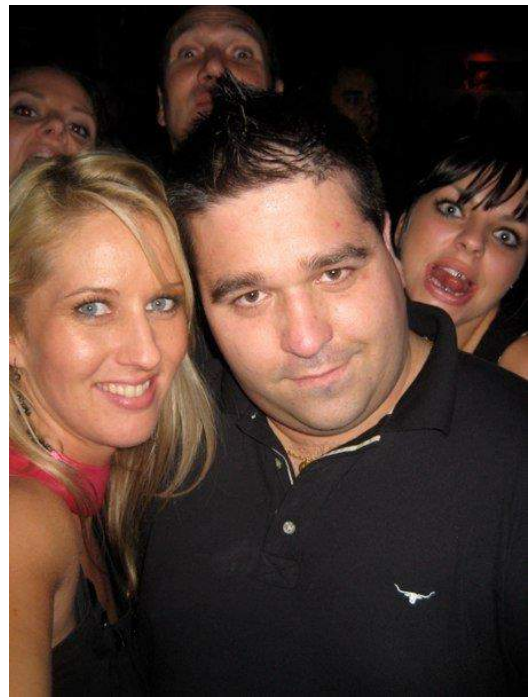

Daniel



Emma Land was the love of Daniel's life. For Valentine's Day, Daniel organised a huge sign to be erected on the corner side of a multi-storey building declaring his love for Emma.

He went into the theatre that evening and when he was able he called letting me know that the cancer was in his bowel, colon and lymph nodes and that he was diagnosed stage 3 cancer. He was in a serious condition. Later that week he had a full set of scans and the cancer was found in his liver and he was now reclassified as stage 4, almost certainly fatal.

Daniel fought hard over the next five months having radiotherapy, chemotherapy and all manner of potent drugs pumped into his body. He developed a terrible rash and he was very unwell. But to his credit he fought hard. Each night we would both go online and play Bridge together to take his mind off the cancer – those midnight to 2:00am sessions were the highlight of his day.



Daniel fought hard through his cancer



I had a long conversation with Daniel the night before he died where I said to him, “Why have you been targeted with this dreadful condition, it should be me?” – he replied, “Hey, Dad, you cannot kill good weeds you know”. The following morning, he got up, made breakfast for Emma, wished her goodbye as she headed to work and he sat down at his computer. A few minutes later he had a pulmonary thrombosis followed by a heart attack and collapsed. He died 6th May 2017 at home.

This is without question the saddest day of my life. Daniel was my only son, the family’s only grandson and my best friend. I miss him dearly.

His funeral was attended by a very large number of people - sadly, his sister, Helen did not attend. His ashes were given to the sea at his favourite beach.

Our two daughters have chosen to cease all communication with the family and I've not heard from either of them in more than 5 years despite making periodic attempts to communicate with them. I am now resigned to the fact that I may never see them again. I have learned that they are both now married (neither Jocelyn nor I were invited to the weddings), but apart from that I have no information.

I have been very fortunate to have close friends who I look to as role models and inspirational mentors. I met Stewart and Pauline Rundle through my association with Seniornet, a club for people aged 55+ who enjoy technology and want to keep in touch with developments. Well before I was age-eligible to join, I became involved with Seniornet North Shore based in Takapuna. I ran a number of classes in Photoshop and other technologies and donated a substantial amount of equipment and software to the club. Stewart and Pauline became close friends and I've always cherished the wisdom and intelligent conversations in which we engage. Also through Seniornet, I have met and have become friends with Barbara Anderson, Lois Kay, Peter Patton, Beryl Parker, Patricia Lough, Carole Wainhouse and so many more wonderful people.

Brett Howes and his fiancé, Amy Hyde are amongst my closest and dearest friends. Brett is an optometrist I have known since the days he was at University completing his degrees. Over the years we have done so much together and we share a love of music, humour and off-the-wall banter. Amy is an accountant who has a beautiful and happy personality. They both invest so much in ensuring those that they know are well-cared for.



Brett and Amy

Robyn Winstone and I have been writing genealogy books for her family for nearly 15 years. She is a sparkling, smart and caring lady who has taken on the responsibility to document the story of one of New Zealand's important industrial businesses. We meet almost every week to research, write and craft new books. She is a very special person in my life. We enjoy conversations on history, family, philosophy and politics and she has become expert in understanding how genealogy and family history books are crafted. Together we have made some exciting discoveries especially around the history of sailing ships that made the arduous journey to New Zealand from England in the 19th century.



Robyn Winstone

I met Sharon Deaker and her husband, Murray through Bridge. Sharon asked me to help her be a better Bridge player and we met often for social games having Daniel and Sharon's sister, Chrissie (her husband was Alan Bollard, a classmate of mine at Selwyn College) along as the other partners. Sharon found Daniel to be a great character and she really enjoyed his company and his daring Bridge antics. On the day Daniel died, Sharon made sure that I was not on my own and insisted that I play Bridge with her in memory of Daniel. I am indebted to her for her support.

About 7 years ago I met Megan Brice. It was a chance meeting in a café at Silverdale. I was delivering some photos to a client who coincidentally was an associate of Megan. For the next few years we kept in semi-regular contact with a quick phone call updating each other on life in general. More recently our friendship has grown and we now keep in regular touch with each other, collaborate on projects, seek advice and wisdom from each other and enjoy a number of social activities together.



Megan Brice

In business, as in life, you're only as good as the people around you. I count myself lucky that my path happened across Megan Brice. Occasionally in life, you meet a remarkable person. Sometimes you are lucky enough to spend some time with them, but you really know that you are fortunate when a remarkable person takes a genuine interest in who you are and where you want to go. Megan is that remarkable person!



Megan and me

I am inspired by her positivity, motivation and experience. She has a grace and enthusiasm for conducting and building a business based on sound and ethical foundations. This is complimented by her deep knowledge of business practices, industrial psychology, training and coaching technique and her special gifts as a speaker, mentor and coach

Recently I was privileged to hear her present a two-hour program to a group in Takapuna where she showed them how they could leave a legacy by being an outstanding coach to their children and grandchildren. The audience were inspired, motivated, energised and lifted by Megan's presentation – a life-changing event for many who were there!

Coincidentally, Megan's father was a well-known and respected optometrist in Whangarei and many years ago I had made the contact lenses that he prescribed for his patients. We met again recently for the first time in many years – a great time remembering the past!

Bridge is an important part of my life. I have been so lucky to meet many wonderful people who love the game and those that play it. I have and have had some outstanding partners who have helped shape my game and my personality. Peter Uffindell and I play on a Tuesday evening and we try hard to improve our game and the banter can be both technical and humorous. His partner June Turner also plays and together they host me for a dinner or two. I started playing with Bob Gibbons about 40 years ago, he's a recognised international Chess champion and judge. We still play together every now and then. A fine gentleman, John Wilson, has been my Bridge partner at Auckland for more than 10 years – we seem to do well and regularly finish in the top three. Others include Steve Laidlaw, Brian MacKenzie, Joy May and so many more!



Peter Uffindell



Me and Bob Gibbons

Over the years I have been fortunate to have won some notable trophies in Bridge and always with the support, expert play and friendship of my wonderful partners. The following are some of the silverware I've won:



TRAUDE LEITL JUNIOR CUP

Awarded to the winning Junior Pair at the Tudor Rosebowl tournament. This cup was presented by Robert Leitl in memory of his wife who played on Wednesday night.

2011 winners: Ian Handricks & Sharon Deaker



BENNETT CUP

Wednesday EVE donated 2007, Section 1 Championship Pairs (Honours Board). Mrs Bennett was President in 1932.

2017 winners: Ian Handricks & John Wilson



PAULINE WEATHERBY SALVER

Wednesday EVE. Donated in 1994 by Pauline Weatherby, a former Club Secretary.

2015 winners: Ian Handricks & John Wilson

2017 winners: Ian Handricks & John Wilson



JOAN McCOWAN CUP

Wednesday Evening. Donated 1980 for the winners of the 5/6 session tournament. Hal McCowan was the main instigator of the Auckland Bridge Club's move from Airdale Street to 273 Remuera Road. Joan McCowan was married to Hal McCowan.

2018 winners: Ian Handricks & John Wilson

2019 winners: Ian Handricks & John Wilson

2023 winners: Ian Handricks & John Wilson



JALFON SALVER

Wednesday Evening Points trophy. F.J. Jalfon was president in 1974/75 and was made a Life Member in 1971.

2012 winner: Ian Handricks

2013 winner: Ian Handricks

2015 winner: Ian Handricks

2016 winner: Ian Handricks

2018 winner: Ian Handricks

2019 winner: Ian Handricks

2020 winner: Ian Handricks

2022 winner: Ian Handricks



Patrick Carter, Auckland Bridge Club Director & Gold Grand Master presenting me with the 2018 Jalfon Salver

Sue Jones is one very special lady. I was playing with another lady at a club one evening when my partner announced that she was not able to play Bridge any longer. She stood up and as quick as a wink, Sue sat down and said, "I want to be your next partner!" She asked me to help her improve her game and this I did. It wasn't too soon after that that she asked me to teach some of her friends how to play. I headed out each Monday to teach the five ladies and before too long they had mastered the game and joined the local club.



Sue Jones (right rear) and the ladies who I taught Bridge

Sue and I have become soul mates and we both enjoy helping people. She introduced me to a family that was looking for a tutor for their son. One sunny afternoon, I met with the parents and they engaged me to start teaching their son, Michael. He finished his time at school and for the last 3 years I have been his only teacher. I teach him all subjects at all levels of college. He has made remarkable progress culminating in the publication of his years' work in large books. I am now also teaching Michael's brothers, this time at a primary school level. I developed a method of teaching that is based around project work. When I first met with Michael he said that his teachers taught him lots of facts but he never got an opportunity to use them. I establish a project topic with Michael that is multi-disciplined, for example I might choose "Greece" as a topic and in the course of completing the work we can cover language, politics, architecture, history, philosophy, astronomy, democracy and food – all aspects of life where Greeks have had an influence.

During the course of his studies I have taught him how to solder and work with electronics (doing this he constructed a working replica of the Enigma machine), provided him the opportunity to meet key people in business where he has been given first-hand knowledge and visited planetariums, museums and many places of educational interest.



Henriette & Elias Nakhle, Megan and me and the Hubtjara team at one of Henriette's wonderful banquets

It was through Sue and Michael's family that I met Henriette and Elias Nakhle, a wonderful couple who have established a beautiful legacy of contributing to the growth of their adopted country of New Zealand. Arriving as new immigrants to New Zealand in the 1960's from modest upbringings in Lebanon, Elias and Henriette set out to build a new life in their adopted country. They built homes, raised a strong family, found friendship, supported and made significant contributions to their community, provided opportunity for many people from many walks of life and found peace and strength in their faith. In 2017 Henriette became the Honorary Consul for Lebanon in New Zealand. She was appointed by The Minister of Foreign Affairs, His Excellency Jibrán Bassil, representing the Lebanese Government and the President, Michel Aoun.

I was commissioned to research and write the story of the family and it was during one of a number of fact-finding visits that Henriette asked for my opinion on an idea that she was thinking about – she said that she would like to set up a facility where New Zealand children could learn to speak and write Arabic. I responded by saying, “I think there is something better we could do”, “why not establish an academy where NZ businesses and Middle Eastern businesses could have a trading platform and where NZ’s could benefit from understanding the language and culture of the Middle East”. She loved the idea and we swung into action. Henriette and Elias hosted a number of exquisite dinners at their home and we laid down the foundations for a new enterprise called “Hub Tijara”.



Hub Tijara was designed to provide a comprehensive range of services to support the growth of business between the Middle East and New Zealand.

These services include education and support for language, culture, etiquette, understanding of the market and knowledge and techniques of how to sell and maintain communication along with the provision of trading services such as market surveying, import/export logistics, financial and market literacy, diplomatic connections and a comprehensive database of business network contacts. The business will be conducted through a sophisticated website. Companies wishing to develop trade or do business in another territory, will be able to choose from a number of discrete services offered by Hub Tijara on its website.

There will be a number of independent and unique service providers associated with the Hub. Each provider will offer a discrete catalogue of services e.g. training, accountancy, market research, IT support, videography, language translation, language education, media management, etc. Each of these service providers will need to be a trusted associate of the Hub Tijara management group and will need to be able to manage growth. The Hub Tijara management group will not engage multiple service providers in one discipline – loyalty to the providers is paramount.

In summary, services will be well-described on the website, show options, provide comprehensive pricing, indicate contact details, provide testimonials etc. All business will come through the Hub. The client will pay the hub to have access to the services chosen by the client. Where we can offer a range the services, the clients can choose online and pay online. The core team was me, Megan Brice, Henriette and Elias Nakhle, Mr. Saad Abou-Chakra and Mrs. Angela Gattung. We invited into the group people who were trusted business associates including Trevor & Lesley Willmot, Phil Dunbar and Miss Hana Malak. We are still poised to launch the operation but have been temporarily halted by the COVID-19 pandemic.

In 2020 I was fortunate to be offered a holiday in the South Island of New Zealand. It turned out to be the trip of a lifetime! The family that hosted me provided me with a 3,500km trip in their private helicopter, a Sikorsky S-76, the full length of New Zealand and back. I flew from Auckland via Paraparaumu (fuel stop), across Cook Strait past Kaikoura and across the Canterbury Plains to arrive at their home at the head waters of Lake Tekapo. I was then given a flight up the Godley River, over the Southern Alps and on up to be alongside the top of Mt Cook! The day was clear and the views and experience were spectacular. The next day I flew from Tekapo down to Manapouri and landing in Queenstown for re-fuelling and lunch at Lake Hayes. We returned via the lakes at the foothills of the Southern Alps. After a few days relaxing and enjoying the wonderful hospitality, I flew back to Auckland via Whanganui. All in all, this was the most exciting and enthralling trip I have ever experienced.

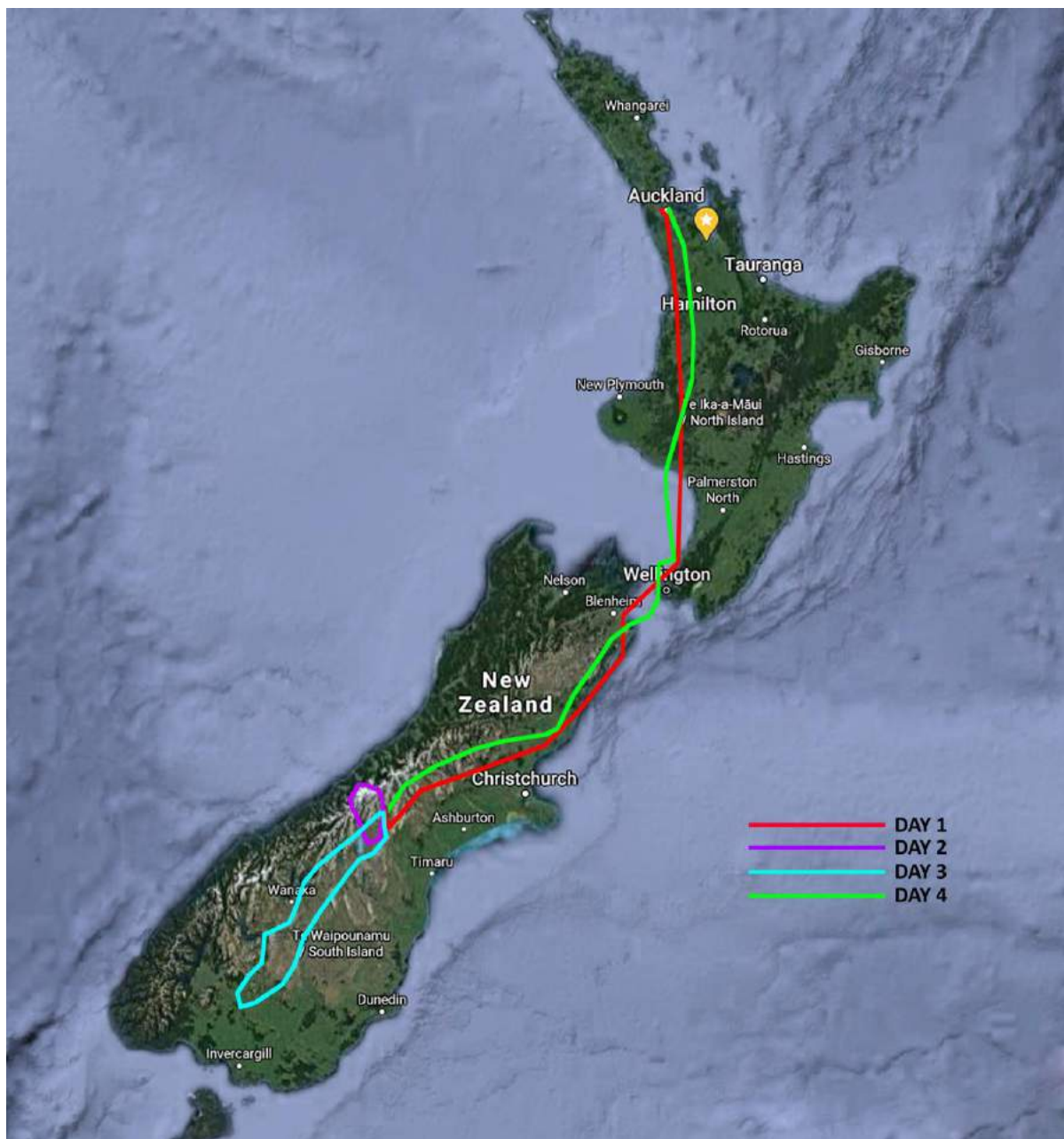







I speak frequently at conferences, seminars and in the community promoting and discussing developments in digital technology, genealogy, optics and business and I am a guest lecturer at the Owen Glenn Business School, University of Auckland where I teach marketing, personal selling, career development and business concepts. In 2012, my tooth-pix business was selected as the key project for final year marketing students to study for completion of their degree.

In 2011, I was appointed as a foundation director of Alexander & Co. Ltd., a leading building surveying company in New Zealand specializing in building enclosures and providing market leading solutions, advice and assistance in all aspects of building surveying, dispute resolution, cladding design, architecture, maintenance planning and building restoration. I was also a consultant with the company providing management, training, business development and career development services. The business of the company was centred around the leaky building issues in the country and we dealt primarily with the significant number of leaky schools. We provided the survey and undertook the remedial work.



On 18th March 2012 I was awarded an Honorary Membership of the Cornea and Contact Lens Society in recognition of outstanding contribution to contact lens practice in New Zealand. It was given for my contribution in original lens design, patents, manufacturing inventions, substantial contributions to the mathematics of optical design, clinical contributions in lens design for astigmatism, keratoconus, post-natal aphakia, bifocal and multifocal contact lenses, production methodology, the development of ground breaking CNC manufacturing optics, surface engineering, materials research, robotics, practice management software and for the introduction of computers into the whole New Zealand optometry market.

I have only been in hospital four times in my life. Firstly, as a small child to have tonsils and adenoids removed (hated the operation, loved the ice cream that followed!). Secondly, when I contracted encephalitis – that was pretty scary, there was serious concern that I might have permanently damaged my brain. I was given all sorts of intelligence tests and fortunately I aced them and was released. Thirdly, to fix a damaged leg and finally a long-awaited operation to remedy an umbilical hernia. I was given a 20% chance of surviving and was told that if I did, I'd be in hospital for a minimum of 4-5 weeks. I had the operation Monday, survived (I wouldn't be writing this if I hadn't!) and was out of hospital and back driving and working by the Thursday of that week. No pain at any stage.

From 2014 I have provided business management training, marketing support and high-level coaching for a number of companies over a diverse scope of disciplines. These include insurance brokers, style and fashion consultants, cartoonists and animators, IT support enterprises, optometrists, dental practices, counsellors and psychotherapists, mortgage brokers, accountants, software support and developers, NLP practitioners, authors and writers, social media experts, restaurateurs, marketing companies and artographers. In supporting these businesses, I have for them created a large number of websites and have provided graphics and design services.



Tony Gill

I continue to provide support and mentoring services to financial advisers. In particular, Tony Gill who I count as a friend and a man of wisdom. Tony has been a financial adviser for a good number of years and is constantly striving to improve his business. It was through Tony that I met Sam Khatri, another financial adviser who was starting to build his enterprise. I have worked alongside Sam in most aspects of his business development and this has culminated in him winning Adviser of the Year four years in succession.



Sam Khatri

Also in 2014 I established NUON, a boutique innovation group which specialises in providing economic IT, graphics and web solutions. I also provide management, writing and marketing support for a number of financial advisors. Also that year I began working with a high profile provincial newspaper supporting business growth and providing editorial and graphic design services. I also designed and delivered a marketing plan for a radiology enterprise based at Ascot Central in Auckland.



Chantele Siedle

I have decided that I should invest some time in helping those that are struggling or need help to get their life and/or business up and running. I've helped a lot of people become successful and in particular, a young lady called Chantele. We had a chance meeting at my office a few months back. I have helped her get a new job and give her the confidence to flourish – which she has done. She has subsequently written a book of the experience!

The family of the children that I teach invited me to share some time with them at their lodge in the South Island. I was treated to a 3,500km helicopter journey traversing the full length of New Zealand. During the week-long tour of New Zealand, I flew the length of the Southern Alps, got alongside the top of Mt Cook, flew to Lake Manapouri, across the Canterbury Plains, around the lakes, rivers and mountains and other notable

landmarks we often dream of seeing. From the snow-capped heights of the Alps, down the azure-blue of Lake Tekapo to the sweeping expanses of Middlemarch – this experience was a life-changer.

I also took another helicopter trip with Michael – this time to Wellington for a few days. We flew down through the middle of the North Island, landing at Wellington Airport and then stayed at the Hilton in Wellington Central. I was hosted at the Beehive and personally given a tour of the Parliament by Hon. Judith Collins. This was followed by a tour of Weta Workshops, Te Papa, the Cable Car and Wellington Observatory and then the flight home via Whanganui.

Recently Megan Brice invited me to contribute to and become a member of a major consortium developing proposals for the Ministry of Health towards improving leadership in New Zealand's Health and Disability System. Much research was undertaken and a large proposal prepared and submitted for consideration. We were short-listed after the first round of submissions and narrowly missed out on selection in the final round. The efforts undertaken were not in vain, we are now working through an opportunity to provide training for a very large healthcare provider.

Recently I was approached by a well-known optometrist who engaged me to develop the mathematics and write a program to calculate the curvatures for a new contact lens design. It felt great working back in optics.



Mark, Sharon and me

Since 2005, I've been involved with a number of business network groups through which I have met many wonderful people who each in their own way have enriched my life. Close friends such as Sharon Fletcher and Mark Garratt bring a sense of family to my life – Sharon has had a roller-coaster ride of ups and downs and Mark has pursued excellence in his career as a Real Estate professional. Together we have enjoyed Sharon's fabulous meals, Mark's supervision of the barbeque and long evenings trading experiences and stories.

I met Phil Dunbar at my very first network meeting. He has over 20 years' experience in market research and worked for larger research companies before starting his own company, Market Knowledge. Melanie Jones is an accomplished accountant, Kerry Dell has expertise in health, Patsy McCook and her husband have a standout accountancy practice, David Ronkowski is a master of business development, Johanna-May Manks is a glorious stylist and there are just so many more who I now call friends that make a difference.

Another exceptional friend is Kevin Crowe, a talented musician and caring father and husband with whom I share a love of music, philosophy and rich conversation. Kevin managed to create beautiful studio recordings of some music I wrote when I was just a seven-year-old. For this and his enduring friendship I shall forever be grateful.



Kevin Crowe

Some of my wonderful friends



Kerry Dell



Patsy McCook



Sue Jones



Sally Spencer-Harris



Davis Ronkowski



Melanie Jones



Adrian Clarke



Steve Laidlaw



Johanna-May Manks



Dawie Otto



Ed Alcock



Jill Alcock



Melissa Perkin



Chris Swain



Denise Boston



Ross Stanley



Amy Hyde



Brett Howes



Peter Uffindell



Robyn Winstone



Vicki Holmes



Ken Holmes



Trevor Willmot



Lesley Willmot



Barbara Anderson



Mark Garratt



Megan Brice



Mike Hocking



Brian MacKenzie



Lois Kay



Natalie Cutler-Welsh



Patricia Lough



Sharon & Murray Deaker



Michael Wight



Geraldine Wight



Diana Ketels



Tony Gill



Joanne Gill



Phil Dunbar



Sharon Fletcher



John Wilson



Tony Hickmore



Stewart & Pauline Rundle



Andrew Willis



Ken Bierman



Angela Royle



Walt & Patty Lewandowski



Vince Yates



Sandie Jennins



Susie Williams



Janice Mogridge



Steve Alexander



Beryl Parker



Martyn Davy



Ed Bernstein



Albert Neilson



Jane Fleming



Ralf Eller



Joan Eller



Matthew Cutler-Welsh



Liz Abbott



Michelle Willis



Robyn Smith



Shilpy Khatri



Bob Gibbons



Chantele Siedle



Doug Dickson



Paula and Andy Dunn



Elias Nakhle



Henriette Nakhle



Graham Fletcher



John Shennan



Karen Guthrie



Noel Templeton



Pauline Chamberlain



Peter Warren



Sam Khatri



Susie Gordon



Laurence O'Connell



Kevin Crowe

Dawie and Davida Otto are special friends. I also met Dawie through networking – he is an exceptional computer wizard who seems to be able to perform miracles with any technology he touches! They have a wonderful family and are building a great business, iTeaspoon. The company name was the result of my whimsy at a meal at their home – it’s brought them good fortune!

At the time my brother Glenn was born I was getting ready to leave home. He and I only ever resided in the same place for a few months. For many years we were not close, mainly due to the unusual state of our parent’s circumstances and the fact that while Glenn was growing up, I was living in England and when I returned to New Zealand, he was living in the Channel Islands in the UK. For a number of years, we had no communication. This all changed the day my son, Daniel, died. I received a call from Glenn who asked to attend the funeral, stand alongside me and to walk with me when the coffin was taken from the service. Since then we have been in regular communication.



Glenn and Fay

Glenn, as it turned out, was trapped in a difficult marriage that had in some ways turned him away from his family. The marriage ended in divorce a few weeks after Daniel died. Glenn’s eldest daughter cut off all ties to him and has since married (Glenn was not invited). Glenn has happily remarried a beautiful and vibrant lady, Fay Wilkinson. They are extremely happy together. Glenn works as an experienced salesman in the industrial electric supply industry.

My sister, Lynette, married a Selwyn College classmate of mine, Siang Huat Ooi, in 1978. Their 43-year marriage has been a happy one and together they have 3 daughters, all of whom have professional careers. Lynette is now a grandmother to a grandson and granddaughter living in Italy. Huat was a professional Electrical Engineers with Fletcher’s for many years. Lynette is currently a manager for Danske Mobler in Botany Downs.



Lynette



My 64th Birthday!

Clockwise from bottom left: Kerry Dell, Shelley Moore, Sue Jones, Megan Brice, Kevin Crowe, Gillian Crowe, Robyn Winstone, June Turner, Brian MacKenzie, Elsje MacKenzie, Sharon Fletcher, Hank Dreyer, Steve Laidlaw, Heather Whineray, Peter Uffindell, Lesley Willmot, Trevor Willmot, me, Mark Garratt, Dawie Otto & Davida Otto



... and the fantastic (keto) cake baked by my good friend, Sue Jones!

Early in 2022, I noticed that my ability to see things clearly was deteriorating rapidly. Words seemed out of focus, contrast was becoming an issue, night vision when driving was frankly scary and it was becoming impossible to function properly. I suspected my glasses were contributing to the problem as the coating had come away from the lens and the visual quality through the lenses was compromised.

I decided to drive over to Whitianga and ask my life-long friend and respected optometrist, Brett Howes, to take a look. He immediately identified that I had cataracts and that I should have them attended to immediately.

He contacted his visiting ophthalmologist, Dr. Chris Murphy and asked him if he could fit me in. He agreed and within 2 weeks I was booked in for the operation to be performed at the Southern Cross Hospital in Hamilton, New Zealand.

The operation is known as Phacoemulsification and is the most common cataract surgery technique performed. Cataract surgery is used to restore vision in patients whose vision has become cloudy from cataracts, a clouding of the eye's lens.

The lens is located behind the iris. It is responsible for focusing light on the retina, and for producing clear, sharp images. The lens has the ability to change shape, known as accommodation. As the eyes age, however, the lens hardens and loses its ability to accommodate. The entire lens is contained within a lens capsule. The light that would normally be focused by the lens is scattered around because of the cloudiness, so vision is no longer clear and sharp.



Brett Howes



Dr Chris Murphy

Phacoemulsification Cataract Surgery

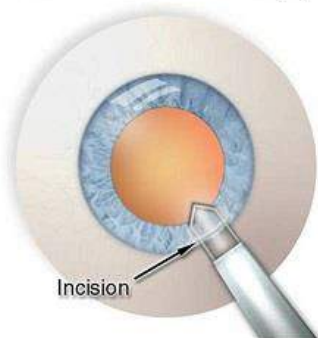

Capsulorhexis

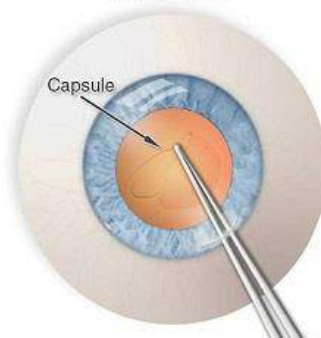

During phacoemulsification, the surgeon makes a small incision at the edge of the cornea and then creates an opening in the membrane that surrounds the lens. A small ultrasonic probe is then inserted, breaking up the cloudy lens into tiny fragments.

The instrument vibrates at ultrasonic speed to chop and almost dissolve the lens material into tiny fragments.

The fragments are then suctioned out of the capsule by an attachment on the probe tip.

After the lens particles are removed, an intraocular lens implant, commonly referred to as an IOL, is implanted and positioned into the lens's natural capsule. It is inserted through the tiny corneal incision through a hollowed-out tube. Once the lens is pushed through, it unfolds and is positioned in place.

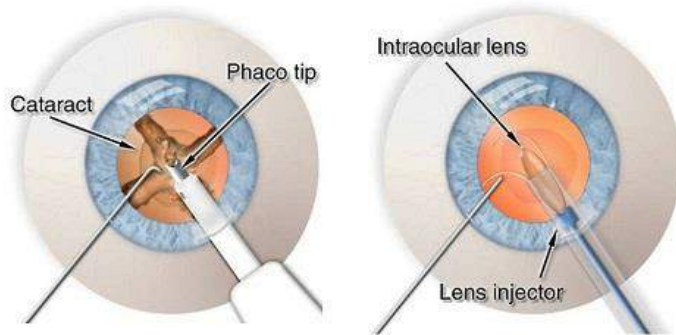

The cataract surgery procedure was performed under topical anaesthesia (numbing drops inserted into the eye).

The operation was completely painless and was surprisingly quick. Immediately following the operation, I needed to wear some protective plastic shield over my eyes (to protect them from accidental touch) – I looked like an escapee from a Horror Movie! (see photo).

The results for my vision have been stunning and life-changing. I now no longer need to wear glasses for normal vision and only require low-cost, low-power spectacles for reading and close work. Colours are now vibrant and contrast stunning – driving at night is now so easy!

My sincere thanks goes out to all of those who helped make this operation happen and who cared enough to give me the opportunity to see with clarity.

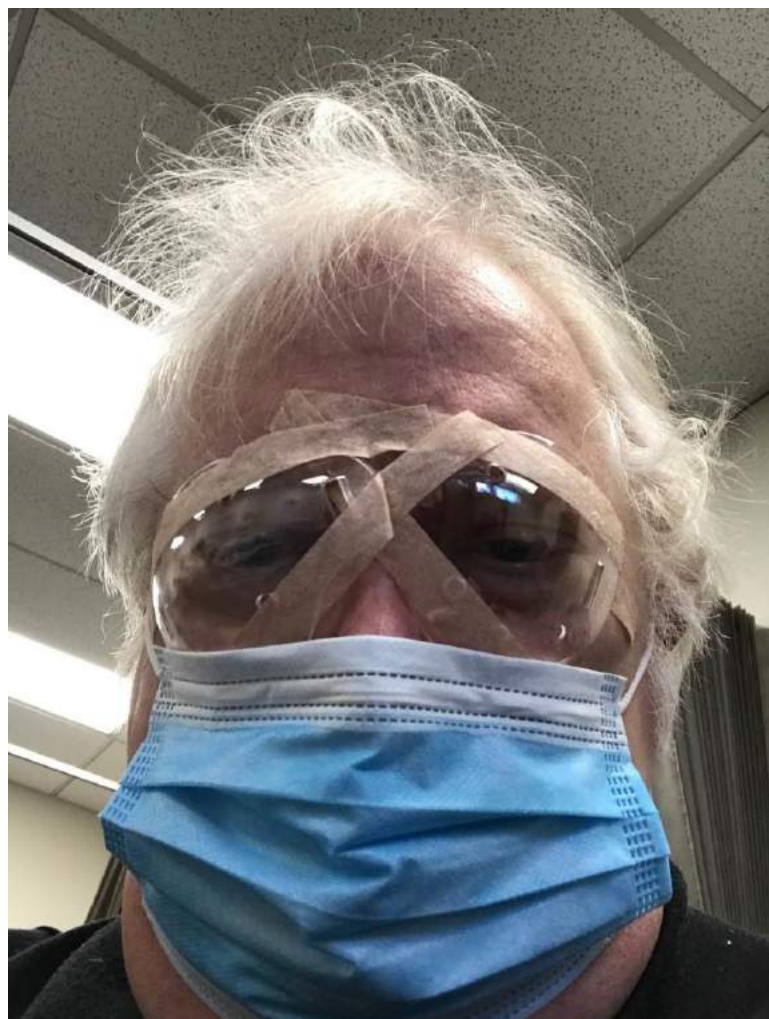

It is with a sense of pride that I am now wearing lenses I helped design nearly 40 years ago. I was very involved with the design and manufacture of Intraocular (IOL) lenses in 1984 using rudimentary CAD software on the first personal computers available at the time. I was featured in “Engineer’s Digest” in June 1986, a specialist magazine dedicated to innovation in engineering design and manufacture. Indeed, the first ever IOL I designed using CAD appears in the article!

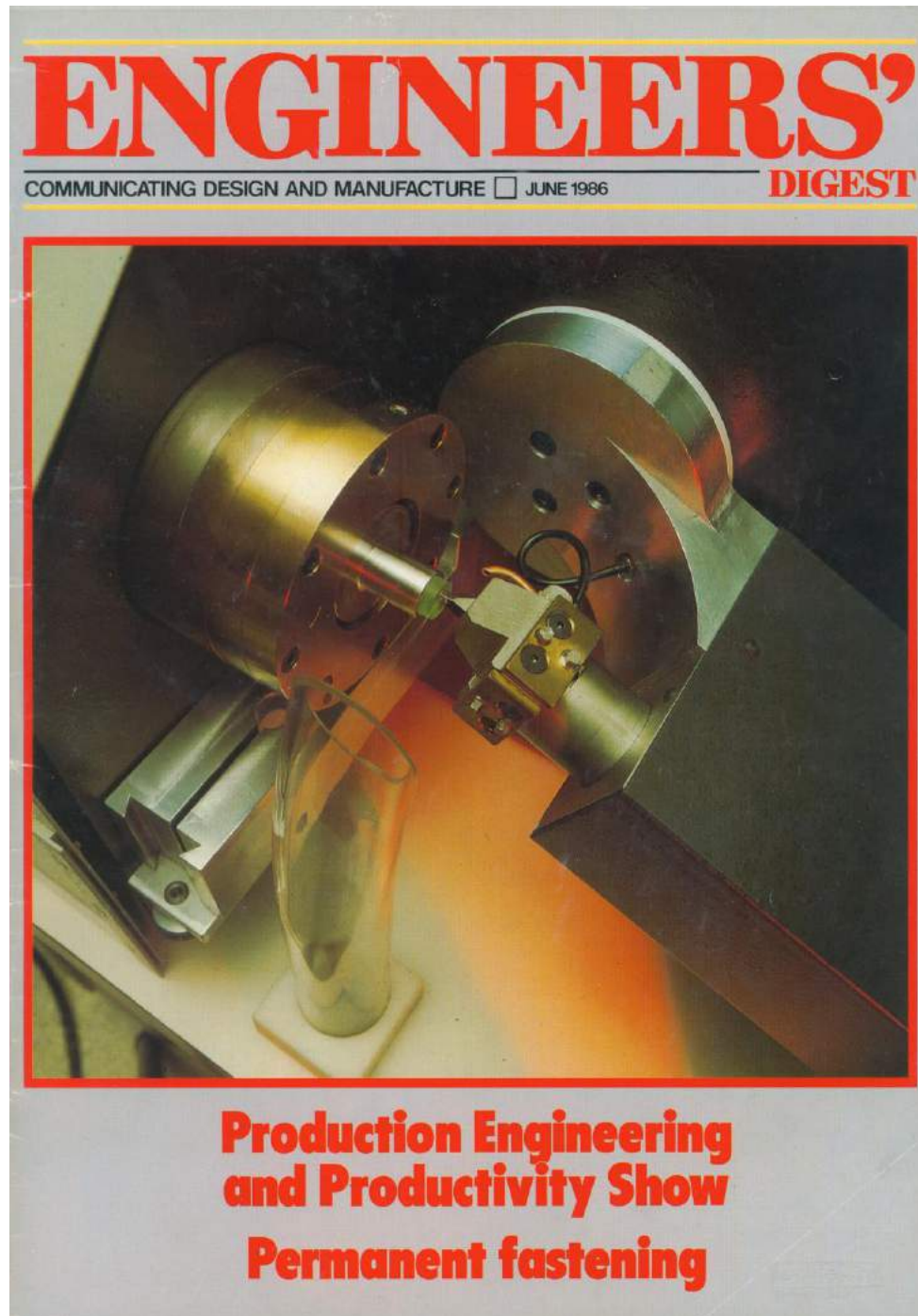

COMPUTER AIDED DESIGN

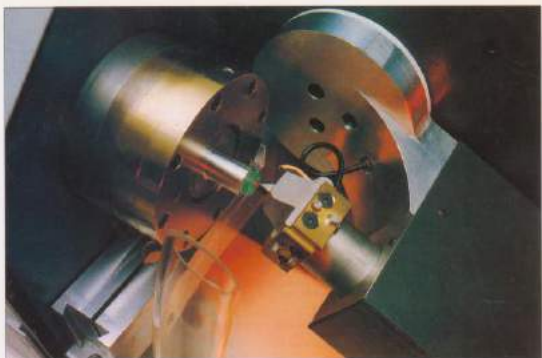

Perfect vision with CAD

Precision means different things to different people. But machining small hemispherical parts only 35 microns thick to a tolerance of 1 micron is ultra-precise by any engineering standards. And when you take in the complex geometrical forms involved and the demands for high productivity and consistent quality, the performance of the Polytech Contact Lens Turning System is quite remarkable.

Designed and built by Contact Lens Supplies (CLS) at High Wycombe, the Polytech is a CNC turning machine which took nearly four years to develop. A prototype was introduced back in 1983 and to date 31 lathes have been built. As well as using the machine itself for contact lens production, CLS sells the Polytech system worldwide with installations in Japan and the USA as well as in Western Europe.

Turning technology
There's no doubt that Contact Lens Supplies has a lead in the technology of turning plastic optical polymers like HEMA contact lenses with the Polytech CNC machine. A key feature in the continuing development process of the diamond

tooling used on the machine, and contact lens design itself, is computer-aided design (CAD). The system selected by CLS enabled its competitive edge in the field of both contact lens design and production in AutoCAD, a general purpose 2D, micro-based package from Autodesk.

Exhibition idea
AutoCAD was bought in September '84 during a visit to the Design Engineering show at the NEC in Birmingham. Ian Handricks, EDP Manager at CLS, initially went to the show to look at computerised inventory control systems but after seeing a demonstration on the AutoCAD stand (the first time, incidentally, he had ever seen CAD in action), he was convinced that micro-CAD could really optimise the company's development programme. He immediately introduced a series of benchmark tests on lens design (such as bringing curves together to see the junction and shifting the curves to different positions) which were very encouraging.

Computer-aided design is helping contact lens manufacturer CLS produce lenses to micron accuracy

COMPUTER AIDED DESIGN

other items of hardware for lens design, engineering drawings and preparing R&D projects for intra-ocular lens work (where the contact lens is actually stitched into the eye), Ian Handricks saw AutoCAD as:

'Giving us the only opportunity to represent and simulate what the Polytech machine actually does'.

To appreciate this, it's worth examining the configuration of the Polytech turning machine to see just how far it's technologically ahead of conventional contact lens turning machines.

The Polytech system offers flexibility in lens design, maintenance, quality and repeatability of product which cannot be matched by any other existing technique. The operator is guided through the programming sequence by a series of simple and interactive menu-type screen displays.

Lathe design
In terms of element design, the lathe has a number of advanced features which enable it to machine high accuracy consistently from lens to lens. The headstock incorporates a precision air-bearing spindle, a high frequency AC motor provides virtually variable spindle speeds from 2000 to 16,000 rev/min and an electronic clearance bearing system brings the spindle to rest in only a second from the top speed. Handracks (usually 6) are added by packable stainless rollers (to three particularly heavy duty or backsets) and is powered by a stepper motor driving through over backlash lead screw and nut.

Spindle chucking is by way of an integral feed-through vacuum system, while chucked tool alignment involves the use of a demountable float-crest TV screen and a high powered (40W) microscope. The headstock is mounted on large diameter, pre-lubricated ball bearings and the radius slide (which actually holds the tool) is a pre-lubricated roller bearing.

Right: A plot they use AutoCAD system of a 300 micron lens. Below: A close-up view of the finished lens.

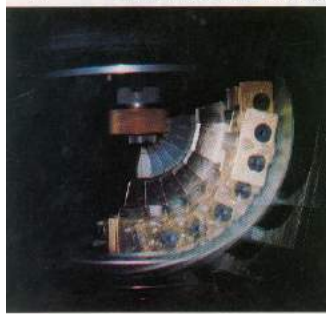

chuck. Adjustment of the latter also uses a stepper motor with zero-backlash lead screw. Air vacuum and ultrasonic pulses to the machine are all monitored by the main computer.

Lead over manual
Compared with hand crank turning machines where the radial slide is fed in by hand—the performance of the Polytech lathe is quite outstanding. In terms of accuracy, the CNC machine is accurate to a repeatable accuracy of 1 micron over a 10mm lens (the tolerance on the traditional type of contact lens

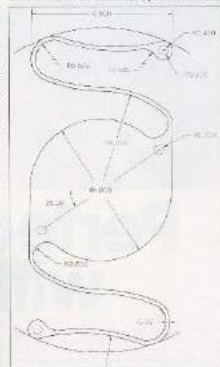

lathe. On the productivity front, the Polytech can produce 130 identical lenses in an hour day. A hand crank machine produces a maximum of 100 in the same time (but such machining is very much operator dependent).

In terms of set-up, it only takes around 5 minutes to change the diamond tool on the CNC machine, whereas it would take between 1 and 2 hours to set-up an conventional lathe. Another plus is that one operator can load after-load Polytech machines, while with hand crank lathes it's a least 1:1 ratio.

However, such impressive performance characteristics don't come cheap initially, a Polytech costs just over £4000 but increased productivity, labour and floor space savings give a 24-30 month payback. As far as the use of AutoCAD is concerned, the CAD system was introduced after the first products were

The first CAD IOL design

...Precision means different things to different people. But machining small hemispherical parts only 35 microns thick to a tolerance of 1 micron is ultra-precise by any engineering standards.

AutoCAD was bought in September '84 during a visit to the Design Engineering show at the NEC in Birmingham. Ian Handricks, EDP Manager at CLS, initially went to the show to look at computerised inventory control systems but after seeing a demonstration on the AutoCAD stand (the first time, incidentally, he had ever seen CAD in action), he was convinced that micro-CAD could really optimise the company's development programme. He immediately introduced a series of benchmark tests on lens design (such as bringing curves together to see the junction and shifting the curves to different positions) results were very encouraging.

So AutoCAD was ordered directly from the Design Engineering Show and used on an IBM PC XT and other items of hardware for lens design, engineering drawings and preparing R&D projects for intra-ocular lens work (where the contact lens is actually stitched into the eye). Ian Handricks saw AutoCAD as; ... 'Giving us the only opportunity to represent and simulate what the Polytech machine actually does'.

Ian Handricks is currently working on 3D CAD (with special additional software developed in-house) for a new range of intraocular contact lenses. Here, full CAD/CAM will be used so that the lens can be designed on AutoCAD and the part program automatically generated and verified on the screen. Manufacturing data will be transmitted down to a prototype NC milling machine in the works...

COMPUTER AID DESIGN



machines had already been built. But for the semi-automated Polytech 2000, a second generation version of the original design, AutoCAD has made a real impact. As well as helping to make ergonomic changes to the machine, it has also produced all the engineering drawings and specifications for the Mk II version. Such draughting routines have saved at least 12 months on project lead times compared with manually produced drawings.

Tool design
AutoCAD has also helped optimize tool design, too—while these natural diamond tools costing around £200 a time, CAD has proved to be a highly effective and economical design tool. By varying tool design in terms of angles, radii and clearance on the screen and simulating the parameters of the resulting scarf (its thickness, radius and shape), the best tool design for the particular cut can be calculated mathematically.

rather than by a series of trial and error tests actually carried out on the machine. Such CAD routines have led to the design of diamond tools which produce better finishes (within 30 Nm peak to valley) and last longer (at least 500 surfaces before a re-grind, instead of only 100 or fewer).

Quality control is another area where AutoCAD has made its presence felt at CLS. The system can generate precise overheads of tooling designs for use on an optical projector to check the form of the tool when it's delivered. Plots of tool insert and shank superimposed on area micrographs are also used in the QC department to highlight any potential problems.

Lens design is the other major area of CAD usage. As well as offering speed and flexibility, AutoCAD also acts as a tool for Ian Handricks and his team to access the full potential of the Polytech 2000 machine. Lens styles, magnifications, optical qualities, color and center design can now be generated, examined very closely and modified quickly. Design work has thus used to take weeks, even months to complete. On AutoCAD, the same tasks can now be carried out in just a few hours.

Lat: Right: AutoCAD drawing of an IOL in. Below: Right: Polytech lathe. Below left: Quality control at CLS.

Over a new style of lens has been created on the screen it's a simple matter to generate the necessary coordinate moves of the headstock and radius slide for inclusion in the part program fed into the Polytech machine.

However, Ian Handricks is currently working on 3D CAD (with special additional software developed in-house) for a new range of intra-ocular contact lenses. Here, full CAD/CAM will be used so that the lens can be designed on AutoCAD and the part program automatically generated and verified on the screen. Manufacturing data will be transmitted down to a prototype NC milling machine in the works.



Late in 2022 the world witnessed the global launch of Artificial Intelligence (AI). I was keen to fully understand this new technology and began studying and learning the processes and applications of AI. I am now giving lectures and running workshops on the technology.

I had been very fortunate to have experienced the early development of AI way back in 1976 when my friend from the DSIR, Denis Malone, gave me the opportunity to see groundbreaking work being done with AI in a process to remove the bones from fish filets. The DSIR had a facility in Auckland at Mt. Albert where a group of scientists and engineers had set up a



production unit that allowed fish filets to move on a metal-mesh conveyer belt into a computer-controlled water-knife cabinet. As the water-knife cut around the bones in the fish the computer was fed back with the result and “learned” to adjust the next cut so that it would cut closer to the bone. By the time a number of fish had been de-boned, the computer was able to refine the cutting process so that the cuts were near perfect.

This was the first time I’d ever seen a computer learn from what it does – the core concept of artificial intelligence. AI is the simulation of human intelligence processes by machines. Many jobs stand to be threatened by AI, however, many tasks will be made easier by AI. Some of these tasks include communication, writing, repetitive tasks, actions requiring predictive decisions, targeted graphic and design, simplification, education, code writing and programming, automation, image processing, proofreading, mathematics & logic, comprehension, data entry, data analysis, pattern recognition, language translation, healthcare analysis, bookkeeping & accounting and much more!

The whole concept of AI is different to what we have known – computer programs before AI were generally step-by-step procedures - one action or command followed by another ... with some steps being a redirection by “if then”.

AI programs do something completely differently – they ingest large amounts of labelled training data, analyze that data for correlations and patterns and then use these patterns to make predictions about future states.

On 30 November 2022 everything changed - ChatGPT was launched! The impact of ChatGPT on the IT world has been immense. It has revolutionized the way people interact with computers, making them more intuitive and user-friendly. It has launched a global AI development frenzy the likes of which we have never before encountered.

Life continues. I'm midway through my seventh decade and everyday new challenges arrive and opportunities present themselves. It's exciting and fulfilling to be living in an age where technology is developing at a pace we could not have imagined some years ago. I remember as a child reading about Dick Tracy and his phone watch – at the time that was pure fantasy – now I have a watch from which I make regular phone calls, a watch which understands what I say to it and one that is able to provide instant answers – and, by the way, it does tell me the time!

I am fortunate that my health is relatively good, my brain is still able to function at a good pace and that prime senses are in good shape. I still maintain a life centred around the rules I made more than 50 years ago. My greatest pleasure is seeing other succeed and flourish. There is nothing more satisfying than to experience the thrill and joy of friends, family and associates achieving and receiving the rewards of honest endeavour.

Sir Isaac Newton once said, "That if I can see further than others it is because I have stood on the shoulders of giants". For me this adage holds true. I am the product of the many people in my life that have guided me, supported and taught me and been there when times were tough. Life has taught me the value of friendship, the wisdom of experience and the generosity of spirit that comes from cheerleaders who give of themselves to ensure my safe and productive journey in this world.



I set out to experience as much as I could, to learn from others, to explore and develop solutions and to be the best that I can. Sure, I've made mistakes, tripped and fallen, scooted past opportunities and could many of times done better than I did – but I have always risen again to fight new challenges, maintained a positive attitude, forever acted in kindness and been grateful for the support of others. Thank you to all who have made my life possible.

TESTIMONIALS

Reflected Experiences



MEGAN BRICE

Managing Director
Integrity Solutions Centre
www.integritysolutionscentre.com

When I first met Ian and asked about his success he explained that his philosophy in life was to live by two guiding principles – kindness and gratitude. I have never met anyone who models these principles with such clarity and consistency as Ian.

Ian has the gift to see more in you than you see in yourself. He builds people up and helps them believe that anything is possible. He is the ultimate teacher, coach, mentor and leader. I have now met a wide range of people that Ian has helped both personally and professionally, through sheer kindness, in a way that has changed their lives. He leaves a lasting, positive impact on people wherever he goes.

Ian is also the most intelligent person I have met in my lifetime. He is able to succeed with the most complex and creative endeavours. He has a unique visionary capacity and can see the end result of all projects. He has the unusual capability to be the visionary, teacher and implementer. He gets things done at a speed most of us cannot comprehend. When he says he will do something for you, it gets done, at lightning speed.

I feel extremely fortunate to have been introduced to Ian. He is a person who can change your life, by seeing opportunity everywhere – for you personally and for your business. Anyone who works with Ian is indeed a very lucky person.



CAROLE GRANT

81 Rifle Range Road
Taupo

I first met Ian Handricks three years ago at a Photographic Conference where he was the key note speaker. I was immediately impressed by his ability to build a rapport with his audience and share his knowledge of photo restoration and genealogy. He inspired his audience with many interesting stories one of which was how he turned a photo restoration hobby into an international success.

The name of this great mentor stayed with me until 2012 when I phoned to ask if he could assist with collating my family history. It was within a week that he produced pages of interesting information about my family. His ability to work on little sleep meant that he was able to compile and produce a very detailed 1200-page document within a year. It came as a set of three books, beautifully bound with colourful images that added life to the final production.

I have been continually amazed and enthused with the information that Ian's unending research has produced. He is a master at bridge and an avid reader. He is a genius.

It is with great interest that I listen to the stories of his life where his ingenuity has taken him to great heights. This includes gaining Honorary Membership of the Cornea and Contact Lens Society, producing templates for changing the face of dentistry. There are many other achievements that are too numerous to list.

Ian is a great teacher and is willing to share his vast knowledge. I was fortunate to learn about many "Apps" from Ian which gave me an understanding of how an iPad works. He likes to see people enjoy life and he enjoys teaching them.

Ian goes out of his way to praise people where service and manners are appreciated. He is a man of integrity that I was happy to have in my home while we were away. It was immaculate on our return from holiday.

I would recommend Ian in any position. This man is simply amazing!



KEN HOLMES

Financial Adviser
Mission Bay
Auckland

If are you looking for someone to die for you then this is the man. He will go to huge lengths to make sure you get what you want.

I have just under 20 years as Ian's business partner and associate. In that whole 20 years I never saw him 'lose the plot'. I have seem him remain calm and focused at different times when we were under huge financial pressure getting our photo restoration start-up working.

It was Ian where the design and speed buck stopped. It was Ian who developed the Photoshop actions which enabled us to restore photos fast and with high quality. It was Ian who consistently produced the good ideas for the operation of our 24 work station operation.

If one was to work with Ian today, they would engage with a polite and funny man who has a good knowledge of who he is. Is always polite, is a good storyteller, software designer, speaker and trainer. His knowledge of computers and in particular iPads is second to none. His mathematical ability is well known in the contact lens industry and the CAM algorithms he developed to lathe contacts lens are still used throughout the world.

Ian has empathy with most people from most walks of life and has spoken at many different locations to many different groups. It is with these strengths and skills in mind that I would highly recommend Ian to any future business associate or customer.



DR. SANDRA D. SMITH PhD, MA(Hons), MA, BA(Hons)

Lecturer

Department of Marketing

The University of Auckland Business School

I have known Ian Handricks for at least six years. Over this time Ian has freely given his time to many of my students as a mentor and also guest lecturer on a number of undergraduate courses.

Ian has such a wealth of business (and general life skills) knowledge that he has made and continues to make an important contribution to the lives of these students. Ian has also, on occasion, offered his extensive editing services to post-graduates who are about to submit their MCom or PhD theses. In addition, Ian and I have worked on various business projects and ideas and I have always found his approach to be intelligent, insightful, creative and certainly cutting edge.

I look forward to continuing to work with Ian as a friend of the University of Auckland Business School, over the coming years.



ANDREW J BURGER

Barrister & Solicitor

Ararat, Victoria, Australia

This testimonial serves to introduce you to Ian Handricks whom I have known since 2007. Ian is one of life's true and unique mavericks. He is a man of exceptional intellect who seldom follows conventional thinking or strategies. Ian has a style that differs from the ordinary – an

inimitable approach that introduces a new dimension of thinking, with accurate big picture focus that visualises issues in their simplest form.

Throughout my association with Ian I have found him to be a reserved person with a rapacious appetite for dealing with issues of complexity – whatever their genesis. Invariably, when general discussion on complex challenges seems exhausted and all ideas spent, Ian will contribute fresh piercing reflections and thought provoking posers. He is the person to have on hand for problem-solving issues or when seeking unprecedented solutions to seemingly irresolvable challenges.

In my erstwhile capacity as a Director of the Auckland District Law Society Inc. in 2008/9, I commissioned Ian to conceptualise a working model through which lawyers could engage in the sale of real estate, based on newly promulgated legislation. After a brief meeting, Ian returned two days later with a meticulously detailed framework and presentation. This demonstrated Ian's extraordinary conceptual skills and his seemingly effortless ability to comprehend the mechanisms of the legal profession.

I am aware of Ian's ground-breaking contributions in the field of optometry, and also that he is a noted genealogist of wide repute who has also distinguished himself as a public speaker. Ian's hobbies include photography, photoshopping, reading, general knowledge, bridge and poetry. He excels in every such capacity.

Ian is a pleasant person, well-liked by my friends and associates, with a delightful sense of humour. He is also an innately generous person who shares his abundant talents and advice openly and freely, but on the flip side he is infuriatingly modest. This is perhaps why he has never aspired to or become the widely renowned or affluent person that his exceptional talents would evidently demand. Mainstream worldly goals matter little to Ian.



HELEN STEEMSON

Copywriter, Course Facilitator,
Company Director
Words for Breakfast Ltd.

In business, as in life, you're only as good as the people around you. I count myself lucky that my path happened across Ian Handricks.

Six years ago, as a fledging business owner, I was inspired and motivated by his positivity, his motivation and above all, his experience. Here, I thought, was a man who could teach me a thing or two about business.

My first reaction proved correct. We've kept in touch over the years, and I've watched Ian lead successive business ventures to fruition with his big picture thinking, and the tightknit group of contacts he's maintained. The longevity and value of these relationships is proof enough of Ian's track record and above all, his deep sense of integrity in his business dealings.

He has been undyingly supportive of Words for Breakfast, in business past my way, in the trust he puts in us and in the value he puts on our service. His word alone has been instrumental in winning significant business for my company – testament to the respect he can garner, and the authority he holds.

I thank Ian for all the time and support he's given me, and look forward to many more brilliant years to come!



TONY HICKMORE

Swimming Coach
Improved Swim Coaching
Taupo

It is my great pleasure to provide this testimonial for Ian as I believe him to be one of the most interesting people I have ever had the good fortune to know.

I met Ian back in the early 1990's when a company I represented supplied technical componentry to his company called Hirstlens. It was during this period that I got to know Ian and discovered a number of his interesting projects that at the time were well ahead of the computer technology we know today.

As our relationship grew I came to work with Ian, at Hirstlens, as he wanted to set up a computer supply company to provide systems and additional services to his customer base of optometrists and ophthalmologists. This addition to the Hirstlens family became known as Beyond Imagination and for which Ian was interviewed on TV and in magazines. Ian saw with Beyond Imagination the opportunity to develop a number of solutions in digital music, photographic restoration and then digitally enhancing x-rays, particularly of mammograms, that allowed for far greater assessments of potential cancer growths.

Even today, Ian's ability to see solutions that others fail to see is one aspect of his skill sets that constantly make me look at any issue in a different light.

Ian's mind seemingly works at 10 times the pace of anyone else I know and no problem would be insurmountable, in fact Ian would rise to the challenge.

I could write a book around the solutions that were developed within Beyond Imagination and believe that Ian's foresight would be an asset in any organisation.

Throughout the last couple of decades Ian and I have kept in touch and I hope that we maintain our friendship for many years to come.

If anyone reading this would like to ask questions about Ian or would like further insights of his skills, then I would be more than happy to elaborate.



JOHN SHENNAN

Former director and
co-owner of Hirstlens
Warkworth

I have known Ian Handricks for some fifty years. I first met Ian when we were under the employment of Hirst Contact Lens NZ Ltd. At that time the company was entering an intensive growth phase, experiencing a similar growth path to that of the fledgling computer industry. Among Ian's many talents is his superior knowledge of applied mathematics. This in itself propelled him within the company when he converted much of the company's optical formulae from manual processing to more efficient methods as provided by the then newly developed programmable calculators. This was pre Apple Mac and PC

Ian went on to continue to develop contact lens manufacturing techniques for the company never short of suggesting changes in traditional manufacturing methods to gain greater efficiencies. Because of his ability to think laterally and question the norm he was offered a position within the company's new research and development facility in the United Kingdom assisting in the development of state-of-the-art contact lens machining systems, some of which were patented. With his R& D duties complete, Ian took up a role in sales and marketing in the company. This virtually took him worldwide where he gained an excellent reputation based on his first-hand knowledge of the contact lens industry.

As Ian's family grew he considered the time was right to return to New Zealand re-joining me to take up an opportunity to enter into a management buyout of Hirstlens. We restructured the company and with Ian's sales and marketing skills, built a strong foundation to develop the company, massively expanding its product range.

At this time Optometry was new to computerisation. A facility was formed to address this. The profession was quick to embrace the advantages of building their own data bases guided by Ian, which in turn gave us the opportunity to form a separate division within the company

leading to further development integrating computers into the photographic industry. Ian was the sole driving force in this initiative which was of great benefit to the company.

Much is owed to Ian's foresight and enthusiasm to succeed, instilling in others the desire to reach their potential. His ability to face challenges in a positive manner has been of great benefit to many of his colleagues.

I consider myself privileged to have worked with Ian, a man of excellent character, blessed with high intelligence and never to avoid an opportunity to help others.



BRETT HOWES B.Sc, Dip. Sci., B.Optom

Mercury Bay Optometrist
Whitianga

I've had the privilege of knowing Ian Handricks for more than 30 years. I first met him when I was an Optometry undergraduate and he was working at Hirst Contact Lens Ltd.

He was a keen teacher of contact lens manufacturing and well respected by all of the students. Later, he taught us all how to use computers and in my case, that was a big challenge!

Ian was singularly responsible for installing computers into every optometry practice in the country and dragging Optometrists into the modern world. He did it with endless, honest and selfless commitment and a total dedication to the job. These are the traits of Ian Handricks.

In every endeavour since, and there have been many, Ian has demonstrated time and time again these attitudes to the job. He is an extraordinary organiser and has the ability to clearly see the objective and map out the steps on the path to that objective.

He can introduce thoughts and ideas which are totally unique and add new colour and direction to the goal.

Any business that involves Ian and channels his abilities will succeed. He has helped me in many ways and I'm proud to call him a friend.



PETER PATTEN

Immediate Past Chairman
SeniorNet North Shore
Auckland

I first met Ian Handricks quite some years ago when he was partly involved in his Hirstlens business, but also launching his online photo restoration business. That was highly impressive.

Later, after I joined SeniorNet North Shore, Ian appeared as a guest speaker & was a highly experienced teacher & demonstrator of such diverse topics as Photoshop, ProShow Gold/Producer (an audio visual program), genealogy & iPads.

Ian has a very high IQ, is very generous with his time & knowledge & is an inspiring teacher who makes friends easily.

I have been very fortunate to know Ian, as well as having gained much from his lessons & talks.



MATTHEW CUTLER-WELSH

Building Science Specialist
Alexander & Co. Ltd

Occasionally in life, you meet a remarkable person. Sometimes you're lucky enough to spend a bit of time with them. But you really know you're fortunate when a remarkable person takes a genuine interest in who you are and where you want to go. Ian Handricks is just such a person.

Ian's reputation as a leader and innovator preceded him when I first had the pleasure of being introduced, soon after I joined Alexander & Co. Ltd. in September 2014. Only six months later, Ian has had an impact on me and I'm truly grateful for having the opportunity to meet, to talk, and to be inspired by him.

As well as being the most available and encouraging board member I've met, Ian has positively impacted people through his formal mentoring role with staff at Alexander & Co. Ltd.

Although I've only known Ian for a relatively short period of time, I know that he's a remarkable person. He has a unique blend of an incredible mind for strategy, invention and business, while also being compassionate, empathetic and emotionally intelligent towards others.

Ian displays all the values and skills that I seek in a great mentor. He has challenged me and encouraged me and I feel I'm better already for having had the privilege to work in an organisation with someone like Ian around. I look forward to more great things to come.



TONY GILL

Director
Gill and Co Ltd

I have known Ian Handricks since 1997 when he became one of my key person clients at a time when he was the CEO of Beyond Imagination Global Ltd. He had just signed with Creekside LLC in North America for the distribution rights of his photo restoration technology and he was recognised for this by becoming a finalist in the Entrepreneur of the Year Awards. It was at this time that Helen Clark, the then NZ Prime Minister, made a visit to his offices in recognition of his accomplishments.

Since then, Ian has devoted a small part of his time to helping me in the preparation of insurance/ACC reports, advising me on business matters and helping with the presentation of our business via website and other media. I value him as a mentor for my business.

I have always considered Ian as having both right and left brain skills – equally competent in analytical and creative pursuits. He has excellent skills in written and oral communication as well as an in-depth understanding of technology.

Regardless of where I am in the country, Ian goes out of his way to ensure that my business keeps running smoothly. Ian has also helped my teenaged son by tutoring him in mathematics (Ian's skills in mathematics are legendary). He has been a good family friend and one whom I can always trust.



CALEB PARKER

Building Science Specialist
Alexander & Co. Ltd.

I have known Ian Handricks since 2013 when I first started working at Alexander & Co. Ltd. My initial experience with Ian was a warm welcome to the team and an immediate offer to provide assistance wherever and whenever necessary. As a Director of Alexander & Co., his ability to engage with every new employee in a respectful, professional and comforting manner never ceases to amaze me.

Ian's broad range of skills makes him an asset to any team in which he is involved. He is a highly intellectual, reliable and well-connected businessman with a truly unique method of thinking and strategizing. Ian's ability to think outside the box and to see the bigger picture makes him an asset to have on your side.

Throughout my time working with Ian, I have found him to be an exceptional mentor for both personal and business related development. When I was tasked with a job to expand a division of our company, Ian was first to propose a business strategy and guide me in the right direction (and I did not have to ask).

I consider it an honour and privilege to work with Ian and would be happy to provide my support to anyone looking to work with him.



ANDREW WILLIS

Director
Azzmax Ltd

I have known Ian for about 15 years and during that time have got to know him both professionally and personally.

I first met Ian when he was developing the PhotoPages™ photo restoration technology and eventually became an investor in this company when it was in the process of becoming a successful and growing business internationally. This company (now named PhotoWonder™) is the most successful photo restoration business in the world employing hundreds of personnel using software that Ian had initially developed in New Zealand.

Ian has continued to develop new and innovative technologies which he has developed into businesses such as Toothpix, a dental imaging software solution.

Ian has many excellent skills including attention to detail, a creative and innovative mind, excellent networking skill, exceptional work ethic and business development skills.

Ian has brokered significant investment funding and been the main provider of the intellectual property behind these successful ideas.



DOUG DICKSON

Director
Photo Illusions Ltd.

My first contact with Ian Handricks was as a supplier to his imaging business in the early 90s while working as the Professional Products Manager for Kodak. Ian's development of the franchise image restoration business linked well within the Kodak product portfolio and a very successful business relationship developed between the two of us.

After leaving Kodak in 2000 I joined Ian's business as a shareholder and Business Development Manager and it was during this time that with Ian's vision and drive we were able to take the business to the international market.

Over the years I have worked with Ian, his desire to develop and implement new products and processes has been a pleasure to be associated with.

Ian is always dedicated and committed to whatever project he is assigned and will always give his very best effort.

Ian's skill set and commitment will be of major benefit to any future business associate or customer.



KEVIN CROWE

Freelance music professional
Sunnynook, Auckland

I've been learning from Ian for about 10 years now, He's the most helpful guy to learn from. For me it's been mostly Photoshop and more recently iPad, but Ian is a huge knowledge source on a broad range of subjects and with years of business experience he's often given me valuable advice regarding my business and family life. His ability to up-skill me to new technology has saved me so much time and whenever I'm stuck on something he's just a phone call away.

We have worked on a number of projects together including website construction, photo slideshow presentations, song arranging and album production

As well as possessing a huge IQ, Ian is friendly, courteous, polite, good humoured, and most of all passionate about imparting knowledge in a dynamic and unforgettable experience of learning. Ian has become a great friend and I highly recommend him and his phenomenal skills to anyone!



PETER GRANTHAM

Associate Building Surveyor
Alexander & Co. Ltd

I have been engaged at Alexander and Co Ltd for almost five years. During this time Ian has been a member of the Board of Directors to provide strategic guidance. In the past two years as my seniority has increased in the company, my interaction with Ian and the board has increased to a point where I can make judgment on the value Ian can provide.

Ian has been engaged as a director and has undertaken supplementary services that were urgently required in terms putting forward and implementing strategic ideas to help diversify and grow the business. Ian has provided in house training and also provided coaching and mentoring to ensure that the staff were fully engaged and listened to.

Ian has an ability to see the potential in people and has provided encouragement to ensure that employees are listened to, coached and most importantly feel valued. Ian has always maintained a positive outlook on the company and has proactively promoted the services

Alexander and Co Ltd could provide, even during his private time. Ian has a wealth of experience in business leadership that are transferable.

I have thoroughly enjoyed working with Ian and would therefore not hesitate to recommend Ian in a similar position.



KERRY SABERTON

L & D Consultant
Bright*Star Training

If you have yet to meet Ian Handricks, I would recommend that you put this at the top of your 'to do' list. There are some people that we meet in life who have a long term effect on us – Ian is one such character. He cares deeply about people and will do anything in his power to help you achieve your potential.

Ian has a lifetime of experience and wisdom to share – time flies in his company and if there is anyone truly worth listening to it's Ian.

I have had the pleasure of working with Ian on the identification and delivery of some very specific training needs – I found this experience insightful to the degree that I am now keen to engage Ian to work with us as a speaker and facilitator.



BARBARA ANDERSON

Chairman
SeniorNet North Shore

I have known Ian Handricks for over 10 years and enjoy his company as a personal friend. As a speaker he has the ability to pass on his knowledge in an interesting and vibrant way including humour at times to keep the interest level high. He handles questions with ease and is always well prepared for his talks.

He is able to field both technical and practical questions and sets up his equipment in plenty of time for lectures. He is extremely knowledgeable and is a divergent thinker, which is a bonus.

Ian has helped me to produce Family History Books and his advice here has been invaluable. He expects high standards of anything he produces and honours his word at all times.

Ian is an Honorary Life Member of our SeniorNet Computing Club and is a favourite speaker of our members. He gives his time freely and is able to cover a wide range of computer based topics. He specialises in iPad and photo restoration but is also capable of many other facets of computing and delights in showing new apps and equipment he has found useful. I have no hesitation in recommending him to others.



KATHY KELL

Managing Director
Legal Accounting Bureau Ltd

I have known Ian Handricks for close to five years. I was first introduced to Ian by a business colleague when I was starting up my own business – Legal Accounting Bureau Limited.

Ian's guidance and encouragement over the last five years have been invaluable to me in getting my business to where it is today. Ian acted as my business mentor offering so much valuable advice regarding the set up of the business and his assistance in marketing strategies and techniques has been fantastic. He was always encouraging and persistent to ensure that I understood what was needed and also put it into practice.

Ian was able to also give me many very valuable referrals to other people who could assist me in different areas such as setting up a website and getting brochures printed.

Ian has always kept in touch to see how things are going and is always able to offer new ideas to consider. If he ever comes across someone or something he thinks may work for me, he always passes it on.

We have become good friends over the last five years. I would not hesitate to recommend Ian to anyone who is in business. He has huge energy and enthusiasm and is so willing to help anyone who shows interest.



SHARYN MORCOM

Outspace Outdoor Solutions Ltd
Cnr Cook Drive & Lee Street
Whitianga, Coromandel Peninsula
New Zealand

I wish we had spoken to Ian before we started our business. Not only could we have avoided a lot of mistakes, but to have enjoyed the sense of enthusiasm, kindly support and brilliance that Ian expels would have given wings to our feet in the early days.

This man has so many strings to his bow that he may as well be the whole orchestra. His wealth of creative ideas is endless and we, as mere mortals, struggle to implement even a few of them. But he has certainly inspired us enough to give it our very best shot. And he understands that we are mere mortals with the most gracious and generous manner.

Ian simply loves to see people succeed and to meet with him and listen to his genius makes it impossible for a little genius not to rub off on you.

Thank you Ian for being so amazing – thank you Ian’s mum for bringing Ian into the world... a very special human being.



CHANTELE SIEDLE

CEO
EmergeSocial

I have met many people but meeting Ian was life changing. Not everyone has the opportunity to run into someone who is so invested in changing people's lives. It wasn't long into my encounter with Ian that everything changed for me. I was unhappy in my job, I felt like there was little hope. Ian spent some time with me getting to know who I was and what I was passionate about. Without hesitation Ian reached out to his network and within a week I had started a life that has been nothing but a pleasure. I met many people who know Ian. It's amazing to hear all the exceptional things Ian has done for himself, but mostly, others, Ian is a kind humble soul that has no problem going the extra mile for people who cross his path. It is an absolute pleasure knowing Ian and everyone who meets him, is sure to feel the same way!



ROCHELLE NARAYAN

Owner & CEO
Celebrate With Me Ltd

Hi my name is Rochelle. I am the owner of Celebrate with Me Ltd. Starting a small business of selling hamper packs is something I have always wanted to do as I just love buying gifts putting it all together in a hamper, decorating cards for birthdays, wedding, hen's night, and of course not forgetting everyone's favourite, Christmas! Thinking about starting all this was easy but putting my plan together was challenging. Trying to find companies who could make my e-commerce website was very hard as the cost was very high and starting a new business, I wanted to keep everything within my budget.

While planning, I met a few amazing people who were guiding me but somehow I got super super lucky when a family friend of mine introduced me to Ian Handricks. Firstly, Ian was easy to approach. Ian was interested in my business as he wanted to know what exactly I was doing so that my website can be made accordingly. While I was getting my side of things sorted, Ian was basically doing my website and he would send me updates and by working together with each other Ian made my website www.celebrate-with-me.com. Ian and I met each other and Ian taught me how to use my own website, he spent hours and hours of his time to ensure that I understood everything I needed to know in order to start an e-commerce business.

When Ian officially completed his part of making the website, I thought that's it but actually I was wrong. Ian basically became my mentor. I had few more difficulties such as setting my payment option and problems with my courier company but Ian helped me a lot by guiding me which steps I have to follow in-order to get all this sorted. It was a long 5-month journey but it's all finally sorted and I am ready to start and till today Ian is still helping me and guiding me. Ian has been my biggest supporter who kept encouraging me that "Rochelle you can do it. Rochelle see the future as it is very bright" throughout this last 5 months I met many people but it's a blessing from God when I met someone as amazing as Ian. Ian thank you very very much for everything you have done for me because most of these wouldn't be possible if I did not have you to guide me and told me to stay positive.



STEFAN (STEF) BILLING

Retired Business Leader

Some years ago, my dear wife Joyce joined North Shore Seniornet to pursue her interest in Photography. She enjoyed the company & the fellowship of members & soon learnt many new tricks about shooting & processing excellent photographs. Her enthusiasm titivated my interest in joining North Shore Seniornet.

I noted that there was a very active ANCESTRY group & decided to jump onboard that group, having had my interest in Family Trees piqued, following an overseas trip which included a visit to the Polygon Woods in Belgium, where my Paternal Grandfather had lost his life in WW1.

Patrick White, or Patsy as he was known to his family, was of Irish decent, born in the north of England, before his family moved south to London where there was plenty of work on the Docks. It was there that he met my grandmother, Catherine Elizabeth Suckling. Being of Irish decent, Patsy referred to my grandmother as Kathleen. Patsy's family were Catholics & Catherine's family were C of E, which in those days, presented a problem for them wanting to marry. Consequently, they emigrated to New Zealand independently, met up in Wellington, married & produced three lovely girls – Rosina, Annie (My Mum), & Kay. With the help & encouragement of others, I managed to discover & document many things about my wider family, using official records & digital programs to develop my first Family Tree.

At this point I got to know Ian on a personal basis. He was always present at the club in the background, assisting in whatever manner he could, sharing his wisdom & passing on his knowledge of researching, building & recording Family Trees, along with a whole lot of computer related Tricks & Treats.

Ian had already produced for some members, several Family Tree Books containing up to 1,000 printed pages per volume, presented on high quality paper, hard bound in personalised covers.

Once these unique, extraordinary creations came to my notice, I knew that I just had to have a couple of sets to hand on to my daughters. As it turned out it took three volumes to capture the history of both Joyce & my family, wherein some data reached back to the year 660.

I must state at this point, that it gives me great pride & pleasure, to be able to hold in my hands, what is effectively, the lives, of a multitude of our joint family relations. Not only that, but I am happy in the knowledge that Joyce & I are passing onto our daughters, a record of where they have come from & who it was that went before them. That knowledge of a journey which took place in real time & space is the GOLD in this exercise!

I could not begin to cover the immense scope of data that Ian has uncovered & the way he has presented such detailed information, which includes photos of places, people, family banners, historical pictures & relationships of note.

The best way to get a handle on it, is to have a chat with Ian & see for yourself, the standard, integrity & creativity of his work.



DAVID RONKOWSKI

Business Consultant
Productivity & Management

I greatly value the work you put into creating the two genealogist volumes you created for me. It provides me and my family with a reference for all the interconnecting branches of the family tree. Wonderful to see a diagrammatic form of the Polish and Welsh side of my family that created some energy to get information from them, knowing it would be captured for prosperity.

One volume was for my wife's side of the family and the other was for mine, so our children have a complete record to refer to and pass on (and maintain) for their families going forward.

It was quite an exercise to pull together lots of information and photographs, personal notes I found that my father had written about when he met my mother, references you found connected to the Polish armoured division my father was assigned to during the war. All of these pieces of paper and photographs would all have been lost or distributed across different places overtime, so it is extremely valuable to have them all in one place and easily referenceable.

They are well presented and very professional. I also appreciated you overcoming many obstacles to achieve an extremely tight timeline to have these printed and ready for when I visited my mother in the UK for her 90th birthday (this was my special gift to her).

My father died in 2001 so to have these personal notes, and wonderful photographs to share with my family was a truly enjoyable and emotional experience.



PAULINE RUNDLE

Retired Teacher

Everyone has a story; your life and experiences are unique. They are special and worth remembering. You have done things in your life that are of great interest to others even if you didn't think so before. You are you and your story is important. Our world and our lives are changing more and more rapidly. Children's lives today bear little resemblance to your childhood. What did you do before TV and the internet? Did you walk to school or ride a

horse? In the past most families spent time on a relative's family farm, did you? How were holidays spent? Did you run free? Or climb a tree in the backyard? How was the shopping done? What were your favourite games? Who were your best friends? How is it all so different from our busy lives today? What about those old photos, what memories do they bring back? What about your teenage years - where did you hang out, who with? Do you have family pictures? Do you want your old, damaged photos brought to life, and coloured, if you want? Getting your story down can be a hugely rewarding experience as well as a lot of fun. Many people have said it's the best thing they've done as it renewed connections with friends and maybe relatives and even teachers they had lost track of over the years.

But maybe you hadn't thought to write it down? Maybe you don't know where to start? Let me assure you, help is at hand. Ian Handricks, Webmaster at North Shore SeniorNet wants to help you get your story done. You think you don't have time? Ian is prepared to sit with you, work with you and get all those fragmented memories, bits of paper, old letters and notes – and photos – into a cohesive whole that you will be thrilled with. Ian is an amazing researcher. In a few minutes, with the sketchiest of information from you, Ian can give you details of your forebears and their lives that you would never have discovered on your own. He can probably find photos of your old school, where you were born, where you grew up. So many possibilities. You owe it to yourself to give it a try now before details become harder and harder to find.

I speak from experience. Ian collated an enormous amount of material for my husband's family history, and his autobiography, and prepared them for publication online. He added many photos to the narrative which already included details of the family surviving the Great Depression. The social lives of the seven children and their parents make fascinating reading and his story, like yours will be, is a very important part of the history of our country or the country you came from. Having your story in print is an option you can choose or not. I cannot recommend Ian's helpfulness and his work too highly.

Ian is helpful, accessible, available, extraordinarily capable in research, photo restoration and has a host of other skills. He has already helped many hundreds of families tell their own stories and many of those have proudly printed their finished work. The proof of the pudding is in the eating and I believe you should take up this offer, look at some of the books that have been printed and grab a chat with Ian as soon as you can. He works out of the SeniorNet room by the Sushi place In Shea Terrace, Takapuna.



CAROL WAINHOUSE

Retired

It has been my absolute pleasure to have known Ian Handricks for many years. I first met Ian in his capacity as a Tutor at SeniorNet North Shore when he was teaching a genealogy session, a subject I was, and continue to be, particularly interested in.

Ian Handricks is a very knowledgeable, competent and generous man and I, like many others, have benefited hugely from his sessions, so much so that he inspired me, after seeing the many wonderful family books he has produced and the research guidance he has given, to have my years of research made into a family book. There was no point, in my opinion, of having all this family research, gained over many years, stored in a computer where nobody could easily access it.

When I initially discussed the idea of producing a family book with Ian and finally decided to go ahead, he initially asked me for my old family photos which he painstakingly sorted into files so they would be easily accessible and then had the enormous task of “working his magic” on these old photos which he completed with absolute brilliance.

Ian then went about working with me and advising where necessary as to the layout of the book, stories to be included, photos to be added and researching further into my family history. After all this work, we sat down together and Ian kindly went through the process of designing and producing my family book, which I, and my family, were more than delighted with.

My family book, including both my husband’s family history and my own, is over 700 pages long and is something that I feel very proud of. I most certainly would never have even attempted to have a book produced without Ian’s expert guidance and knowledge. All through this process, Ian was very approachable, generous with his time and advice and professional. I have recommended Ian to many people, not only to assist in writing their family stories but also on any aspects of researching, photo editing etc.



SHARON DEAKER

Businesswoman
Media Management

I have known Ian Handricks for over 15 years. In that time, I have come to know him as not only as an exceptional genealogist and historian, but also a top bridge player and instructor.

Ian has a remarkable talent for bridging the gap between the past & present, and he has the innate ability to bring history to life through his work.

The family history book he did for my family takes pride & place in our library. One of the things that I appreciate most about Ian's writing is his meticulous attention to detail.

He has an incredible ability to research and gather information and he presents it in a clear concise manner that is easy to follow. He approaches everything he writes with a spirit of intellectual curiosity and humility.

He greets each family history challenge with a level of professionalism and attention to detail that is truly inspiring. His hardback books on genealogy are a testament to his skill, as he seamlessly weaves together the historical photos and text to create a vivid and engaging family masterpiece.

As a bridge player and instructor Ian is without peer. His passion for the game is contagious, and he has a talent for breaking down complex concepts into simple easy to understand terms whether you are a seasoned player or a complete novice, Ian has a way of making the game accessible to all.

Ian is honest, forthright, direct & strong.

In short I cannot recommend Ian Handricks highly enough. He is a true master of his craft and a truly exceptional person.

MY GENEALOGY

Details of main ancestral lines

These pages contain details of my genetic heritage. They are but a small portion of my ancestry. Over the last 45 years I have researched and gathered information on more than six million names that form the basis of my family history database.

I can trace my genealogy back in an unbroken and direct line to the beginnings of human existence. My ancestors include Kings, Queens, Tsars, Emperors, explorers, scientists, authors, rogues, vagabonds, despots, landed gentry, Jewish nomads, artists, actors, politicians, Pharaohs, physicians and every other person of notable character.

My ethnicity is a mixture of European genes:

English	66%
Irish	13%
Dutch	9%
Scottish	6%
German	3%
Italian	3%

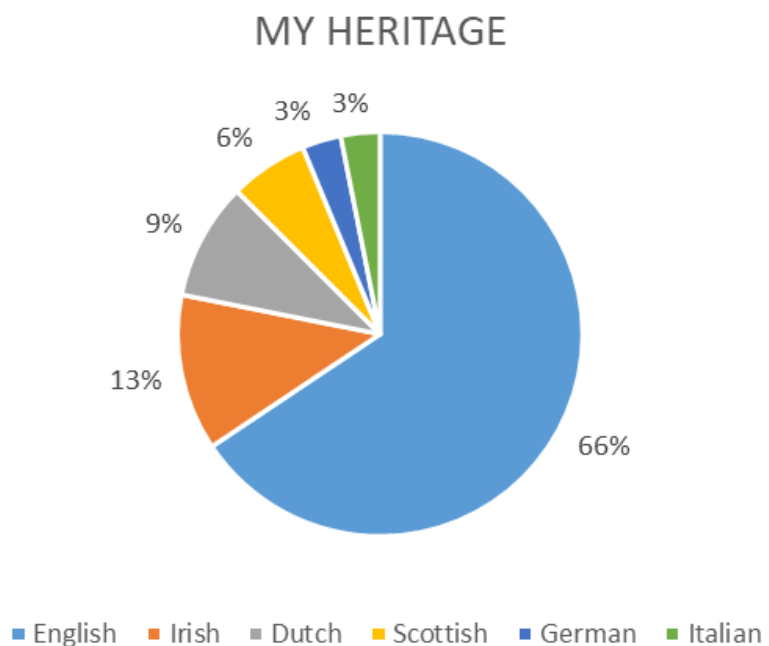

Ancestors of Ian Lister Handricks

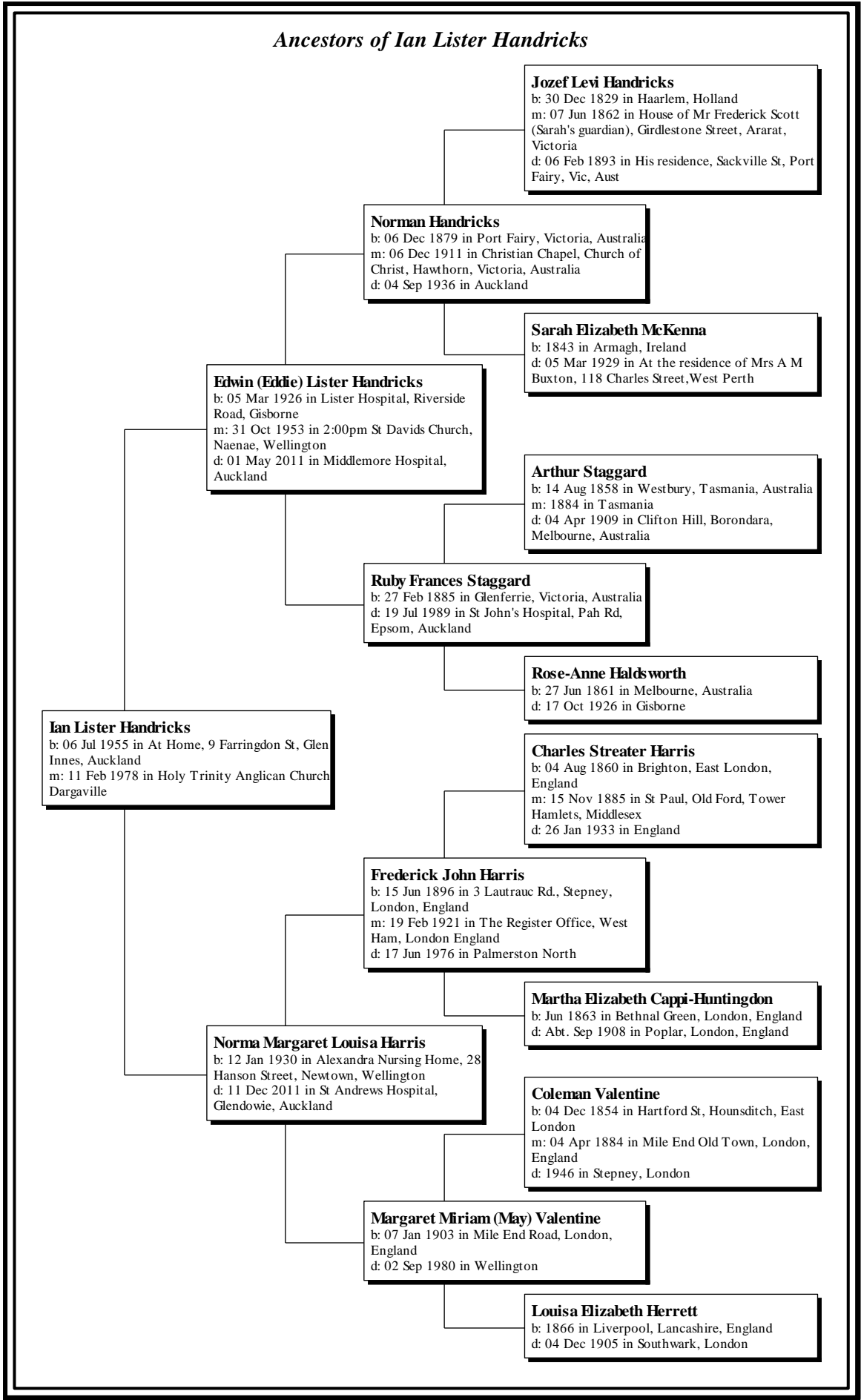

Jozef Levi Handricks
 b: 30 Dec 1829 in Haarlem, Holland
 m: 07 Jun 1862 in House of Mr Frederick Scott (Sarah's guardian), Girdlestone Street, Ararat, Victoria
 d: 06 Feb 1893 in His residence, Sackville St, Port Fairy, Vic, Aust

Norman Handricks
 b: 06 Dec 1879 in Port Fairy, Victoria, Australia
 m: 06 Dec 1911 in Christian Chapel, Church of Christ, Hawthorn, Victoria, Australia
 d: 04 Sep 1936 in Auckland

Sarah Elizabeth McKenna
 b: 1843 in Armagh, Ireland
 d: 05 Mar 1929 in At the residence of Mrs A M Buxton, 118 Charles Street, West Perth

Edwin (Eddie) Lister Handricks
 b: 05 Mar 1926 in Lister Hospital, Riverside Road, Gisborne
 m: 31 Oct 1953 in 2:00pm St Davids Church, Naenae, Wellington
 d: 01 May 2011 in Middlemore Hospital, Auckland

Arthur Staggard
 b: 14 Aug 1858 in Westbury, Tasmania, Australia
 m: 1884 in Tasmania
 d: 04 Apr 1909 in Clifton Hill, Borondara, Melbourne, Australia

Ruby Frances Staggard
 b: 27 Feb 1885 in Glenferrie, Victoria, Australia
 d: 19 Jul 1989 in St John's Hospital, Pah Rd, Epsom, Auckland

Rose-Anne Haldsworth
 b: 27 Jun 1861 in Melbourne, Australia
 d: 17 Oct 1926 in Gisborne

Ian Lister Handricks
 b: 06 Jul 1955 in At Home, 9 Farrington St, Glen Innes, Auckland
 m: 11 Feb 1978 in Holy Trinity Anglican Church Dargaville

Charles Streater Harris
 b: 04 Aug 1860 in Brighton, East London, England
 m: 15 Nov 1885 in St Paul, Old Ford, Tower Hamlets, Middlesex
 d: 26 Jan 1933 in England

Frederick John Harris
 b: 15 Jun 1896 in 3 Lautrauc Rd., Stepney, London, England
 m: 19 Feb 1921 in The Register Office, West Ham, London England
 d: 17 Jun 1976 in Palmerston North

Martha Elizabeth Cappi-Huntingdon
 b: Jun 1863 in Bethnal Green, London, England
 d: Abt. Sep 1908 in Poplar, London, England

Norma Margaret Louisa Harris
 b: 12 Jan 1930 in Alexandra Nursing Home, 28 Hanson Street, Newtown, Wellington
 d: 11 Dec 2011 in St Andrews Hospital, Glendowie, Auckland

Coleman Valentine
 b: 04 Dec 1854 in Hartford St, Houndsditch, East London
 m: 04 Apr 1884 in Mile End Old Town, London, England
 d: 1946 in Stepney, London

Margaret Miriam (May) Valentine
 b: 07 Jan 1903 in Mile End Road, London, England
 d: 02 Sep 1980 in Wellington

Louisa Elizabeth Herrett
 b: 1866 in Liverpool, Lancashire, England
 d: 04 Dec 1905 in Southwark, London

Descendants of Joel Joseph Hangjas Turfkruijer

Generation No. 1

1. JOEL JOSEPH HANGJAS¹ TURFKRUIJER was born Abt. 1690 in Russia.

Children of JOEL JOSEPH HANGJAS TURFKRUIJER are:

2. i. LEVY JOEL HANGJAS² TURFKRUIJER, b. Abt. 1720.
3. ii. MOSES JOEL HANGJAS TURFKRUIJER.

Generation No. 2

2. LEVY JOEL HANGJAS² TURFKRUIJER (*JOEL JOSEPH HANGJAS¹*) was born Abt. 1720.

Child of LEVY JOEL HANGJAS TURFKRUIJER is:

4. i. JOSEPH JOZALE ABRAHAM HANGJAS³ TURFKRUIJER, b. Abt. 1745, Frankfurt, Darmstadt, Hesse, Germany; d. 11 Jan 1823, Amsterdam.

3. MOSES JOEL HANGJAS² TURFKRUIJER (*JOEL JOSEPH HANGJAS¹*)

Child of MOSES JOEL HANGJAS TURFKRUIJER is:

5. i. JOSEPH MOSES HANGJAS³ DUVEEN, d. 1813.

Generation No. 3

4. JOSEPH JOZALE ABRAHAM HANGJAS³ TURFKRUIJER (*LEVY JOEL HANGJAS², JOEL JOSEPH HANGJAS¹*) was born Abt. 1745 in Frankfurt, Darmstadt, Hesse, Germany, and died 11 Jan 1823 in Amsterdam. He married REBECCA ISAAC Abt. 1780. She was born Abt. 1749 in Berlin, Germany, and died 17 Sep 1824 in Haarlem, North Holland, Netherlands.

Children of JOSEPH TURFKRUIJER and REBECCA ISAAC are:

6. i. LEVIE JOSEPH JOZALE⁴ HANGJAS, b. 23 May 1784, Amsterdam, Netherlands; d. 21 Nov 1843, Haarlem.
7. ii. MARCUS MORDECHAI JOSEPH JOZALE HANGJAS TURFKRUYE, b. 1785, Amsterdam; d. 11 Nov 1853, Haarlem, North Holland, Netherlands.
- iii. ISAAC ITSAK JOSEPH JOZALE HANGJAS, b. 1783, Amsterdam; m. MARIANNA MERLA ISAAC ITSAK VAN DER LINDEN; b. Abt. 1785; d. Abt. 1849, Amsterdam.

5. JOSEPH MOSES HANGJAS³ DUVEEN (*MOSES JOEL HANGJAS² TURFKRUIJER, JOEL JOSEPH HANGJAS¹*) died 1813. He married LENA LEVY. She died 1813.

Child of JOSEPH DUVEEN and LENA LEVY is:

8. i. ENOCH ELKAN JOSEPH⁴ DUVEEN, b. 12 May 1781, Grosen Besseik, Duitsland; d. 28 Dec 1867, Meppel, Drenthe, Nederland.

Generation No. 4

6. LEVIE JOSEPH JOZALE⁴ HANGJAS (*JOSEPH JOZALE ABRAHAM HANGJAS³ TURFKRUIJER, LEVY JOEL HANGJAS², JOEL JOSEPH HANGJAS¹*) was born 23 May 1784 in Amsterdam, Netherlands, and died 21 Nov 1843 in Haarlem. He married HENDERIJNTJE HINDELE PRINS JOSEPH WELKOOMST Abt. 1811. She was born 1790 in The Hague, Netherlands, and died 18 Nov 1847 in Haarlem.

Children of LEVIE HANGJAS and HENDERIJNTJE WELKOOMST are:

9. i. JOZEF LEVI⁵ HANDRICKS, b. 30 Dec 1829, Haarlem, Holland; d. 06 Feb 1893, His residence, Sackville St, Port Fairy, Vic, Aust.
10. ii. JACOB LEVI HANGJAS, b. 11 Feb 1819, Haarlem, Nth Holland, Netherlands; d. 31 Jul 1903, Haarlem, Nth Holland, Netherlands.
11. iii. MARCUS LEVI HANGJAS, b. 1822, Haarlem; d. 09 Apr 1867, Rotterdam.
iv. BETJE LEVI HANGJAS, b. 1824.
v. JOZEF ABRAHAM HANGJAS, b. 19 Sep 1823; d. 11 May 1824.
vi. JOZEF LEVI HANGJAS, b. 02 Nov 1826; d. 03 Oct 1828.
vii. ABRAHAM LEVIE HANGJAS, b. 1815; d. 16 May 1815, 8 days old, Amsterdam.
12. viii. MOZES LEVI HANGJAS, b. 23 Dec 1813, Amsterdam, Netherlands; d. 15 Jul 1900, Haarlem, Nth Holland, Netherlands.

7. MARCUS MORDECHAI JOSEPH JOZALE HANGJAS⁴ TURFKRUYE (*JOSEPH JOZALE ABRAHAM HANGJAS³ TURFKRUIJER, LEVY JOEL HANGJAS², JOEL JOSEPH HANGJAS¹*) was born 1785 in Amsterdam, and died 11 Nov 1853 in Haarlem, North Holland, Netherlands. He married SARA SAMSON VOS RUNSFELD 1807 in Amsterdam, daughter of SAMSON RUNSFELD and ESTHER VOSLOG. She was born 1788 in Amsterdam, and died 31 Jan 1861 in Haarlem, North Holland, Netherlands.

Children of MARCUS TURFKRUYE and SARA RUNSFELD are:

13. i. RACHEL MARCUS⁵ HANGJAS, b. 06 Feb 1813, Amsterdam, Netherlands; d. 27 Dec 1891, Haarlem, Nth Holland, Netherlands.
ii. ISAAC MARCUS HANGJAS, b. 18 Jan 1815, Amsterdam, Netherlands; d. 1905.
14. iii. JOSEPH MARCUS HANGJAS, b. 19 Mar 1817, Amsterdam, Netherlands; d. 1908.
15. iv. JANNETJE MARCUS HANGJAS, b. 20 Feb 1819, Den Burg, Texel, Netherlands; d. 1913.
16. v. SCHOONTJE SJEINE HANGJAS, b. 27 Mar 1811, Den Burg, Texel, Netherlands; d. 10 Dec 1890.
vi. BETJE HANGJAS, b. 08 Jul 1826, Den Burg, Texel, Netherlands; d. 1920.
vii. ANNAATJE HINDELE HANGJAS, b. Abt. 1806, Amsterdam, Netherlands; m. SALOMON MEIJER DREES, 16 Apr 1828, Amsterdam, Netherlands; b. Abt. 1805, Amsterdam, Netherlands.
17. viii. MAARTJE MARCUS HANGJAS, b. Bef. 1828; d. 1878.

8. ENOCH ELKAN JOSEPH⁴ DUVEEN (*JOSEPH MOSES HANGJAS³, MOSES JOEL HANGJAS² TURFKRUIJER, JOEL JOSEPH HANGJAS¹*) was born 12 May 1781 in Grosen Besseik, Duitsland, and died 28 Dec 1867 in Meppel, Drenthe, Nederland. He married EVA ISAAK MOZES GODFRIED 01 Jun 1813 in Meppel, Drenthe, Nederland, daughter of IZAAC GODFRIED and RACHEL GOMPERS. She was born 02 Oct 1790 in Meppel, Drenthe, Nederland, and died 25 Jul 1864 in Meppel, Drenthe, Nederland.

Children of ENOCH DUVEEN and EVA GODFRIED are:

18. i. JOSEPH⁵ DUVEEN, b. 05 Jun 1814, Meppel, Drenthe, Nederland; d. 1877, Meppel.
19. ii. MOZES DUVEEN, b. 18 Aug 1816, Meppel; d. 12 Aug 1877, Zwolle.
iii. LENA DUVEEN, b. 21 Mar 1819, Meppel, Drenthe, Netherlands; d. 25 May 1881; m. JACOB MOZES VAN ESSO, 12 Oct 1836, Meppel, Drenthe, Netherlands.
20. iv. RACHEL DUVEEN, b. 18 Jul 1822, Meppel, Drenthe, Netherlands; d. 09 Feb 1866, Zwolle.
v. SALOMON ENOCH DUVEEN.
21. vi. SARA DUVEEN, b. 14 Dec 1826, Meppel, Drenthe, Netherlands; d. 07 Jan 1899, Assen.

Generation No. 5

9. JOZEF LEVI⁵ HANDRICKS (*LEVIE JOSEPH JOZALE⁴ HANGJAS, JOSEPH JOZALE ABRAHAM HANGJAS³ TURFKRUIJER, LEVY JOEL HANGJAS², JOEL JOSEPH HANGJAS¹*) was born 30 Dec 1829 in Haarlem, Holland, and died 06 Feb 1893 in His residence, Sackville St, Port Fairy, Vic, Aust. He married SARAH ELIZABETH MCKENNA 07 Jun 1862 in House of Mr Frederick Scott (Sarah's guardian), Girdlestone Street, Ararat, Victoria, daughter of JAMES MCKENNA and ELIZABETH COPE. She was born 1843 in Armagh, Ireland, and died 05 Mar 1929 in At the residence of Mrs A M Buxton, 118 Charles Street, West Perth.

Children of JOZEF HANDRICKS and SARAH MCKENNA are:

22. i. NORMAN (NORRIE) FREDERICK JAMES⁶ HANDRICKS, b. 06 Dec 1879, Port Fairy, Victoria, Australia; d. 04 Sep 1936, Auckland.
23. ii. SARAH ELIZABET (LILY) HANDRICKS, b. 28 Feb 1863, Port Fairy, Victoria, Australia; d. 15 Jan 1921, Private Hospital in Geelong.
- iii. ANNA MARIA HANDRICKS, b. 1865, Ararat; d. 1866, Ararat.
24. iv. AMELIA (MILLIE) JANE HANDRICKS, b. 1867, Ararat; d. 03 Apr 1958, Mt Henry, West Australia.
25. v. ARTHUR WILLIAM HANDRICKS, b. 1869, Ararat, Victoria, Australia; d. 27 Feb 1945, Private Hospital, Perth.
26. vi. ISABELLA (BELLA) HANDRICKS, b. 1871, Belfast, Victoria, Australia; d. 1934, New Zealand.
- vii. JOSEPH HANDRICKS, b. 1874, Belfast, Vic; d. 1875, Belfast, Vic.
- viii. HENRY (HARRY) HANDRICKS, b. 29 Aug 1876, Belfast, Vic.; d. 1962, Rotorua.
- ix. GLADYS MAY HANDRICKS, b. 1880, Belfast, Vic; d. 18 Jun 1885, Port Fairy, Victoria, Australia.

10. JACOB LEVI⁵ HANGJAS (*LEVIE JOSEPH JOZALE⁴, JOSEPH JOZALE ABRAHAM HANGJAS³ TURFKRUIJER, LEVY JOEL HANGJAS², JOEL JOSEPH HANGJAS¹*) was born 11 Feb 1819 in Haarlem, Nth Holland, Netherlands, and died 31 Jul 1903 in Haarlem, Nth Holland, Netherlands. He married (1) JOHANNA MIEZERUS 07 Oct 1847 in Haarlem, daughter of JAN MIEZERUS and JANSJE SERNEE. She was born 14 Mar 1821 in Haarlem, Nth Holland, Netherlands, and died 20 Jan 1880 in Haarlem, Nth Holland, Netherlands. He married (2) HEINTJE MEIBERGEN 23 Jan 1882 in Stad, Almelo, Overijssel, Netherlands, daughter of LEVII MEIBERGEN and SAARTJE HAGENS. She was born 19 Oct 1841 in Stad, Almelo, Overijssel, Netherlands.

Children of JACOB HANGJAS and JOHANNA MIEZERUS are:

27. i. HENRI JACOB⁶ HANGJAS-DUVEEN, b. 1848, Haarlem, Nth Holland, Netherlands; d. 1877, Haarlem, Nth Holland, Netherlands.
- ii. BERNARD HANGJAS, b. 1863, Haarlem; m. ANTJE TJAKKE VAN LIER, 24 Sep 1886, Appeldoorn; b. 1858, Hoogeveen.
28. iii. CATHARINA JOHANNA HANGJAS, b. 1855.
29. iv. JANSJE HANGJAS, b. 1856, Haarlem.
30. v. JOHANNES HANGJAS, b. 1850, Haarlem; d. 22 Oct 1927.

11. MARCUS LEVI⁵ HANGJAS (*LEVIE JOSEPH JOZALE⁴, JOSEPH JOZALE ABRAHAM HANGJAS³ TURFKRUIJER, LEVY JOEL HANGJAS², JOEL JOSEPH HANGJAS¹*) was born 1822 in Haarlem, and died 09 Apr 1867 in Rotterdam. He married MARIE HELENA CAROLINA WANTENAAC 05 May 1852 in S-Gravenhage, Zuid Holland, Netherlands, daughter of THOMAS WANTENAER and JOHANNA BREEMEN. She was born 20 Nov 1825 in Den Haag.

Children of MARCUS HANGJAS and MARIE WANTENAAC are:

31. i. LOUIS MARINUS ANTONIUS⁶ HANGJAS, b. 08 Mar 1853, Leiden; d. 26 Sep 1912, Haarlem.
32. ii. CAREL JACOB HANGJAS, b. 21 Sep 1855, Rotterdam; d. 02 Jun 1896, Haarlem.
- iii. CATHARINA HELENA MARIA HANGJAS, b. 19 Feb 1857, Rotterdam; d. 23 Nov 1857, Rotterdam.
- iv. JOHANNES THOMAS HANGJAS, b. 16 Feb 1859, Rotterdam; d. 26 Jun 1859, Rotterdam.

12. MOZES LEVI⁵ HANGJAS (*LEVIE JOSEPH JOZALE⁴, JOSEPH JOZALE ABRAHAM HANGJAS³ TURFKRUIJER, LEVY JOEL HANGJAS², JOEL JOSEPH HANGJAS¹*) was born 23 Dec 1813 in Amsterdam, Netherlands, and died 15 Jul 1900 in Haarlem, Nth Holland, Netherlands. He married RACHEL MARCUS HANGJAS 03 Jan 1834 in Texel, Nth Holland, Netherlands, daughter of MARCUS TURFKRUYE and SARA RUNSFELD. She was born 06 Feb 1813 in Amsterdam, Netherlands, and died 27 Dec 1891 in Haarlem, Nth Holland, Netherlands.

Children of MOZES HANGJAS and RACHEL HANGJAS are:

- i. LEVIE⁶ HANGJAS, b. 20 Nov 1837, Haarlem, Nth Holland, Netherlands.
- ii. MARRETJE MOZES HANGJAS, b. 17 Oct 1843, Haarlem, Nth Holland, Netherlands; m. LEVIE ISAAC KETELLAPPER; b. 12 May 1843, Amsterdam.
33. iii. SAARTJE HANGJAS, b. Abt. 1842, Haarlem, Nth Holland, Netherlands; d. 05 Mar 1908, Rotterdam.
- iv. NAATJE HANGJAS, b. Abt. 1859, Haarlem, Nth Holland, Netherlands; m. (1) FREDERIK CHRISTIAAN FUCHS, 04 Jun 1891, Amsterdam; m. (2) HENDRIK VAN EL, 09 Feb 1921, Amsterdam; b. Abt. 1850, Haarlem.
- v. MARCUS HANGJAS, b. Abt. 1835, Haarlem, Nth Holland, Netherlands; d. 13 May 1838.
- vi. HENDERIJNTJE SARA HANGJAS, b. Abt. 1836, Haarlem, Nth Holland, Netherlands; d. 26 Jan 1854.
- vii. MARCUS HANGJAS, b. Abt. 1849, Haarlem, Nth Holland, Netherlands.
- viii. NAATJE HANGJAS, b. 23 Apr 1840, Haarlem, Nth Holland, Netherlands; d. 26 Jan 1854.

13. RACHEL MARCUS⁵ HANGJAS (*MARCUS MORDECHAI JOSEPH JOZALE HANGJAS⁴ TURFKRUYE, JOSEPH JOZALE ABRAHAM HANGJAS³ TURFKRUIJER, LEVY JOEL HANGJAS², JOEL JOSEPH HANGJAS¹*) was born 06 Feb 1813 in Amsterdam, Netherlands, and died 27 Dec 1891 in Haarlem, Nth Holland, Netherlands. She married MOZES LEVI HANGJAS 03 Jan 1834 in Texel, Nth Holland, Netherlands, son of LEVIE HANGJAS and HENDERIJNTJE WELKOO MST. He was born 23 Dec 1813 in Amsterdam, Netherlands, and died 15 Jul 1900 in Haarlem, Nth Holland, Netherlands.

Children are listed above under (12) Mozes Levi Hangjas.

14. JOSEPH MARCUS⁵ HANGJAS (*MARCUS MORDECHAI JOSEPH JOZALE HANGJAS⁴ TURFKRUYE, JOSEPH JOZALE ABRAHAM HANGJAS³ TURFKRUIJER, LEVY JOEL HANGJAS², JOEL JOSEPH HANGJAS¹*) was born 19 Mar 1817 in Amsterdam, Netherlands, and died 1908. He married JUDIK DE JONG 05 May 1839 in Texel, Netherlands, daughter of LEVI DE JONG and MIETJE KLEPMAN. She was born 1814 in Haarlem, Nth Holland, Netherlands, and died 1909.

Children of JOSEPH HANGJAS and JUDIK DE JONG are:

34. i. MARCUS JOSEPH⁶ HANGJAS, b. 03 Jul 1839, Haarlem, Nth Holland, Netherlands; d. 15 Apr 1898, Leiden.
- ii. SAMSON JOSEPH HANGJAS, b. 26 Aug 1846, Haarlem, Nth Holland, Netherlands; d. 08 May 1901, Haarlem, Nth Holland, Netherlands; m. SAARTJE MOK, 22 Sep 1886, Haarlem; b. 23 Oct 1853, Haarlem, Nth Holland, Netherlands; d. 09 Aug 1926, Haarlem, Nth Holland, Netherlands.
35. iii. SIMON HANGJAS, b. 13 Aug 1857, Haarlem; d. 16 Aug 1876.
- iv. NAATJE HANGJAS, b. 03 Mar 1853, Haarlem, Nth Holland, Netherlands; d. 1947.
36. v. SARA HANGJAS, b. 12 Jul 1854, Haarlem, Nth Holland, Netherlands; d. 23 Nov 1942, Amsterdam, Netherlands.
- vi. DAVID JOSEPH HANGJAS, b. 07 Aug 1842, Haarlem, Holland; d. 23 Dec 1842, Haarlem, Holland.
- vii. MIETJE HANGJAS, b. 28 Oct 1843, Haarlem, Holland; d. 16 Sep 1845, Haarlem, Holland.
- viii. LEVI HANGJAS, b. 22 Mar 1845, Haarlem, Holland; d. 02 Oct 1845, Haarlem, Holland.

15. JANNETJE MARCUS⁵ HANGJAS (*MARCUS MORDECHAI JOSEPH JOZALE HANGJAS⁴ TURFKRUYE, JOSEPH JOZALE ABRAHAM HANGJAS³ TURFKRUIJER, LEVY JOEL HANGJAS², JOEL JOSEPH HANGJAS¹*) was born 20 Feb 1819 in Den Burg, Texel, Netherlands, and died 1913. She married (1) ANDRIES VELLEMAN 1840 in Haarlem, son of LEVIE VELLEMAN and LEENTJE DE VRIES. He was born 11 Jul 1819 in Haarlem. She married (2) MOZES PAARDEBEK 1841 in Haarlem, son of SALOMON PAARDEBEK and FLORA DE VRIES. He was born Abt. 1824 in Haarlem, and died 11 Mar 1855 in Haarlem.

Children of JANNETJE HANGJAS and ANDRIES VELLEMAN are:

- i. LEVIE⁶ VELLEMAN, b. 10 Mar 1861, Haarlem; m. JANE SPIER, 02 Aug 1882, Haarlem; b. 1859, Alkmaar.
- ii. LEENTJE VELLEMAN, b. Abt. 1867; d. 01 Oct 1938, Leiden; m. IZAAK FRANSMAN, 07 Apr 1886, Haarlem; b. Abt. 1866, Hilversum.

Children of JANNETJE HANGJAS and MOZES PAARDEBEK are:

37. iii. CORNELIA⁶ PAARDEBEK, b. Abt. 1850, Haarlem.
- iv. MARCUS MOZES PAARDEBEK, b. Abt. 1844, Haarlem; m. ESTHER SCHREUDER, 29 Jan 1873, Haarlem; b. Abt. 1853, Utrecht.
38. v. NAATJE PAARDEBEK, b. Abt. 1851, Haarlem.

16. SCHOONTJE SJEINE⁵ HANGJAS (*MARCUS MORDECHAI JOSEPH JOZALE HANGJAS⁴ TURFKRUYE, JOSEPH JOZALE ABRAHAM HANGJAS³ TURFKRUIJER, LEVY JOEL HANGJAS², JOEL JOSEPH HANGJAS¹*) was born 27 Mar 1811 in Den Burg, Texel, Netherlands, and died 10 Dec 1890. She married HARTOG ELIAS VLESSING 28 Mar 1844 in Texel, Netherlands, son of DAVID LESSING and DUIFJE DE LEEUW. He was born 30 May 1818 in Purmerend, Noord Holland, Netherlands, and died 28 Nov 1885.

Children of SCHOONTJE HANGJAS and HARTOG VLESSING are:

- i. NAATJE⁶ VLESSING, b. 14 Jun 1864, Haarlem, Nth Holland, Netherlands; d. 27 Jun 1864, Haarlem, Nth Holland, Netherlands.
- ii. IZAAK VLESSING, b. 02 Nov 1847, Texel, Noord Holland, Netherlands; d. 20 Dec 1878.
39. iii. SAMUEL VLESSING, b. Abt. 1850, Texel, Noord Holland, Netherlands; d. Bef. 1888.
- iv. MIETJE VLESSING, b. 1854, Texel, Noord Holland, Netherlands; m. ABRAHAM TROOSTWIJK; b. 11 Nov 1838, Leeuwarden; d. 25 May 1898, Amsterdam.
- v. SARA VLESSING, m. HARTOG DE JONG, 18 Oct 1882; b. Abt. 1855, Gorinchem.
- vi. ELIEZER HARTOG VLESSING, b. Abt. 1840, Haarlem; m. SAARTJE DE JONGH, 18 Nov 1868, Haarlem; b. Abt. 1848.

17. MAARTJE MARCUS⁵ HANGJAS (*MARCUS MORDECHAI JOSEPH JOZALE HANGJAS⁴ TURFKRUYE, JOSEPH JOZALE ABRAHAM HANGJAS³ TURFKRUIJER, LEVY JOEL HANGJAS², JOEL JOSEPH HANGJAS¹*) was born Bef. 1828, and died 1878.

Child of MAARTJE MARCUS HANGJAS is:

40. i. IZAAK JOSEF⁶ HANGJAS, b. Abt. 1846, Haarlem.

Child of MAARTJE MARCUS HANGJAS is:

- ii. MARCUS⁶ HANGJAS, b. Abt. 1857, Haarlem; m. ALIDA VAN DEN BOOGAART, 09 Nov 1904, Amsterdam; b. Abt. 1869, Amsterdam.

18. JOSEPH⁵ DUVEEN (*ENOCH ELKAN JOSEPH⁴, JOSEPH MOSES HANGJAS³, MOSES JOEL HANGJAS² TURFKRUIJER, JOEL JOSEPH HANGJAS¹*) was born 05 Jun 1814 in Meppel, Drenthe, Nederland, and died 1877 in Meppel. He married EVA VAN MINDEN 07 Apr 1842 in Zwolle, Overijssel, Nederland, daughter of JOEL VAN MINDEN and JETTJE RIES. She was born 19 Feb 1812 in Zwolle, Overijssel, Nederland, and died 22 Aug 1864 in Meppel.

Children of JOSEPH DUVEEN and EVA VAN MINDEN are:

41. i. BETJE⁶ DUVEEN, b. 04 Nov 1850, Meppel; d. 1918.
42. ii. JOEL JOSEPH DUVEEN, b. 30 Apr 1843, Meppel; d. 09 Nov 1908, Hyeres, France.
- iii. JETTE DUVEEN, b. 1845, Meppel; m. WOLTJE ?, 1865.
43. iv. HENRY HENOCH JOSEPH DUVEEN, b. 26 Oct 1854, Meppel; d. 1915.

19. MOZES⁵ DUVEEN (*ENOCH ELKAN JOSEPH⁴, JOSEPH MOSES HANGJAS³, MOSES JOEL HANGJAS² TURFKRUIJER, JOEL JOSEPH HANGJAS¹*) was born 18 Aug 1816 in Meppel, and died 12 Aug 1877 in Zwolle. He married SAARTJE VECHT 16 Apr 1842 in Burgerlijke Stand, Elburg, Gelderland, Netherlands. She was born 14 Apr 1817 in Elburg, and died 12 Nov 1856 in Zwolle.

Children of MOZES DUVEEN and SAARTJE VECHT are:

- i. JOZEF MOZES⁶ DUVEEN, b. 17 Feb 1853, Zwolle; m. BETJE DUVEEN, 1883; b. 04 Nov 1850, Meppel; d. 1918.
44. ii. EVA DUVEEN, b. 24 Mar 1843, Zwolle; d. 01 Apr 1891, Apeldoorn.
45. iii. HEIMAN MOZES DUVEEN, b. 19 Apr 1845, Zwolle.
46. iv. HENOCH MOZES DUVEEN, b. 01 Apr 1848, Zwolle.
- v. REINTJE DUVEEN, b. 13 Apr 1849, Zwolle, Overijssel, Netherlands; d. 03 Apr 1865.
47. vi. IZAAK DUVEEN, b. 15 May 1851, Zwolle.
48. vii. WOLF DUVEEN, b. 26 Feb 1855, Zwolle.

20. RACHEL⁵ DUVEEN (*ENOCH ELKAN JOSEPH⁴, JOSEPH MOSES HANGJAS³, MOSES JOEL HANGJAS² TURFKRUIJER, JOEL JOSEPH HANGJAS¹*) was born 18 Jul 1822 in Meppel, Drenthe, Netherlands, and died 09 Feb 1866 in Zwolle. She married JOSEPH JOEL KOOPMAN. He was born 13 Apr 1814.

Children of RACHEL DUVEEN and JOSEPH KOOPMAN are:

- i. EVA⁶ KOOPMAN, b. 24 Aug 1853, Zwolle; m. BENJAMIN GOSSCHALK; b. 1852.
- ii. KAREL KOOPMAN, b. 24 Mar 1855, Zwolle; d. 07 Mar 1915, Muiderberg; m. REINA JOHANNA KAMERLING, 24 Jun 1896, Gouda; b. 02 Apr 1867, Veendam.
- iii. AALTJE KOOPMAN, b. 28 Nov 1865, Zwolle.

21. SARA⁵ DUVEEN (*ENOCH ELKAN JOSEPH⁴, JOSEPH MOSES HANGJAS³, MOSES JOEL HANGJAS² TURFKRUIJER, JOEL JOSEPH HANGJAS¹*) was born 14 Dec 1826 in Meppel, Drenthe, Netherlands, and died 07 Jan 1899 in Assen. She married MICHAEL NATHANS 1849.

Children of SARA DUVEEN and MICHAEL NATHANS are:

- i. NATHANS⁶ NATHANS, b. 1850.
- ii. BETJE NATHANS, b. 1857, Assen.

Generation No. 6

22. NORMAN (NORRIE) FREDERICK JAMES⁶ HANDRICKS (*JOZEF LEVI⁵, LEVIE JOSEPH JOZALE⁴ HANGJAS, JOSEPH JOZALE ABRAHAM HANGJAS³ TURFKRUIJER, LEVY JOEL HANGJAS², JOEL JOSEPH HANGJAS¹*) was born 06 Dec 1879 in Port Fairy, Victoria, Australia, and died 04 Sep 1936 in Auckland. He married RUBY FRANCES STAGGARD 06 Dec 1911 in Christian Chapel, Church of Christ, Hawthorn, Victoria, Australia, daughter of ARTHUR STAGGARD and ROSE-ANNE HALDSWORTH. She was born 27 Feb 1885 in Glenferrie, Victoria, Australia, and died 19 Jul 1989 in St John's Hospital, Pah Rd, Epsom, Auckland.

Children of NORMAN HANDRICKS and RUBY STAGGARD are:

49. i. EDWIN (EDDIE) LISTER⁷ HANDRICKS, b. 05 Mar 1926, Lister Hospital, Riverside Road, Gisborne; d. 01 May 2011, Middlemore Hospital, Auckland.
- ii. GWENDOLINE ROSE CORRICK HANDRICKS, b. 03 Oct 1912, Granville, Sydney; d. 02 Nov 2000, Auckland Hospital, Auckland, New Zealand.
50. iii. ROBERT HARRY HANDRICKS, b. 08 Apr 1920, Gisborne; d. 07 Aug 2007, Dargaville.
51. iv. NORMAN LESLIE HANDRICKS, b. 19 Sep 1915, Wellington; d. 27 Jan 2004, Whakatane.
52. v. DOUGLAS HUBERT NELSON HANDRICKS, b. 25 Aug 1917, Nelson; d. 09 May 1981, Sydney.
- vi. WILLIAM HANDRICKS, b. 08 Apr 1920, Gisborne; d. 08 Apr 1920, Gisborne.

23. SARAH ELIZABET (LILY)⁶ HANDRICKS (*JOZEF LEVI⁵, LEVIE JOSEPH JOZALE⁴ HANGJAS, JOSEPH JOZALE ABRAHAM HANGJAS³ TURFKRUIJER, LEVY JOEL HANGJAS², JOEL JOSEPH HANGJAS¹*) was born 28 Feb 1863 in Port Fairy, Victoria, Australia, and died 15 Jan 1921 in Private Hospital in Geelong. She married LEOPOLD EMANUELL JOSEPH 20 Jun 1888 in at the residence of E Bramestan Esq JP, Minister at St Andrews, Port Fairy, Victoria, Australia, son of JOSEPH JOSEPH and DINAH DAVIS. He was born 03 Apr 1866 in Sunderland, Durham, England, and died 10 Mar 1929 in Geelong.

Children of SARAH HANDRICKS and LEOPOLD JOSEPH are:

53. i. MORRIS CEDRIC CLARE⁷ JOSEPH, b. 08 Dec 1890, Ballarat, Victoria, Australia; d. 07 Aug 1972, Windsor, Victoria.
- ii. PRIVATE JOSEPH DAVIS DE PASSE JOSEPH, b. 18 Jun 1900, Melbourne, Victoria, Australia; d. 20 Jul 1916, Killed in Action WW1, Fleurbaix, Formelles, France.
- iii. OLGA BELLA DAVIS DE PASSE JOSEPH, b. 1895, Ballarat, Victoria, Australia; d. 1896.

24. AMELIA (MILLIE) JANE⁶ HANDRICKS (*JOZEF LEVI⁵, LEVIE JOSEPH JOZALE⁴ HANGJAS, JOSEPH JOZALE ABRAHAM HANGJAS³ TURFKRUIJER, LEVY JOEL HANGJAS², JOEL JOSEPH HANGJAS¹*) was born 1867 in Ararat, and died 03 Apr 1958 in Mt Henry, West Australia. She married WILLIAM PENN TOMPSON 17 Apr 1900 in Christ Church (Anglican), Claremont, Perth, son of PIDDOCKE TOMPSON and JANE ARMYTAGE. He was born 12 Oct 1853 in "Bexley Estate" Cooks River, Petersham, New South Wales, and died 17 Apr 1936 in At his residence, 22 St. George's Terrace, Perth.

Child of AMELIA HANDRICKS and WILLIAM TOMPSON is:

54. i. IRIS VERA ISABELLE⁷ TOMPSON, b. 19 Sep 1901, "Paynesville", Shenton Rd., Claremont; d. 30 Aug 1981, Sir Charles Gairdner Hospital, Nedlands, Perth.

25. ARTHUR WILLIAM⁶ HANDRICKS (*JOZEF LEVI⁵, LEVIE JOSEPH JOZALE⁴ HANGJAS, JOSEPH JOZALE ABRAHAM HANGJAS³ TURFKRUIJER, LEVY JOEL HANGJAS², JOEL JOSEPH HANGJAS¹*) was born 1869 in Ararat, Victoria, Australia, and died 27 Feb 1945 in Private Hospital, Perth. He married ANNIE (NANCE) PRICE 27 Jul 1898 in St Alban's Hall, Perth, daughter of ALFRED PRICE and MARY SLINES. She was born 01 Jan 1882 in Connecticut, USA, and died 19 Apr 1957 in at her daughter's residence, 7 Elstree Avenue, Mt Lawley, Mt Perth, Perth, on Good Friday.

Children of ARTHUR HANDRICKS and ANNIE PRICE are:

55. i. CLARENCE (CLARY) ALBERT ARTHUR LESLIE⁷ HANDRICKS, b. 22 Nov 1901, at his parent's residence 82 Charles street, West Perth; d. 16 Apr 1971, Mt Lawley, Perth.
- ii. MARY SYLVIA EMMA HANDRICKS, b. 1912; d. Aft. 1936, Perth; m. WALTER RICHARD HUTTO STEPHENS, 19 Dec 1936, Forrest Park Methodist Church, Walcott St, Mt. awley, Perth; b. 1906, Claremont, Western Australia; d. 12 Dec 1973, 7 Elstree Avenue, Mt Lawley, Mt Perth, Perth.

26. ISABELLA (BELLA)⁶ HANDRICKS (*JOZEF LEV⁵, LEVIE JOSEPH JOZALE⁴ HANGJAS, JOSEPH JOZALE ABRAHAM HANGJAS³ TURFKRUIJER, LEVY JOEL HANGJAS², JOEL JOSEPH HANGJAS¹*) was born 1871 in Belfast, Victoria, Australia, and died 1934 in New Zealand. She married (1) WILLIAM JOHN PAYNE 14 Sep 1895 in Metropolitan Wesleyan Church, Cape Town, South Africa, son of WILLIAM PAYNE and ELIZABETH WILLIAMS. He was born 1868 in Ballarat, Victoria, Australia, and died 05 Aug 1900 in On board H.M.S. China, near Perth. She married (2) WILLIAM HENRY ERNEST CROME 1901 in Kiama, NSW, Australia, son of WILLIAM CROME and LYDIA WILSON. He was born 07 Jun 1867 in Sydney, Australia, and died 09 Nov 1928 in Wellington, New Zealand.

Child of ISABELLA HANDRICKS and WILLIAM CROME is:

- i. MADELAINE BELLE⁷ CROME, b. 1902, Lismore, New South Wales, Australia; d. 1976, Rotorua; m. (1) ROY JAMES ANDERSON BROWN, 1924, New Zealand; b. Jan 1903, Wellington, New Zealand; d. Mar 1954, Wellington, New Zealand; m. (2) THOMAS MAHON DERMODY, 1956, New Zealand.

27. HENRI JACOB⁶ HANGJAS-DUVEEN (*JACOB LEV⁵ HANGJAS, LEVIE JOSEPH JOZALE⁴, JOSEPH JOZALE ABRAHAM HANGJAS³ TURFKRUIJER, LEVY JOEL HANGJAS², JOEL JOSEPH HANGJAS¹*) was born 1848 in Haarlem, Nth Holland, Netherlands, and died 1877 in Haarlem, Nth Holland, Netherlands. He married BETJE DUVEEN 05 Dec 1872 in Haarlem, daughter of JOSEPH DUVEEN and EVA VAN MINDEN. She was born 04 Nov 1850 in Meppel, and died 1918.

Children of HENRI HANGJAS-DUVEEN and BETJE DUVEEN are:

- i. JOEL CHARLES⁷ DUVEEN, b. 1876; d. 1904, Transvaal, South Africa.
- ii. JAMES HENRY DUVEEN, b. 1873, Haarlem; d. Aft. 1956; m. ESTHER DUVEEN, 21 Nov 1911; b. 07 Nov 1870, Hull; d. 22 Nov 1949.
- iii. EVALINE DUVEEN.
- iv. HENRI FRANÇOIS HANGJAS, b. Abt. 1878, Den Haag; m. ROZA ROOZENDAAL, 18 Aug 1909, Deventer; b. Abt. 1883, Deventer.
- v. ? DUVEEN.

28. CATHARINA JOHANNA⁶ HANGJAS (*JACOB LEV⁵, LEVIE JOSEPH JOZALE⁴, JOSEPH JOZALE ABRAHAM HANGJAS³ TURFKRUIJER, LEVY JOEL HANGJAS², JOEL JOSEPH HANGJAS¹*) was born 1855. She married JACOB ROMEIN 23 Nov 1876 in Haarlem. He was born Abt. 1853 in Leeuwarden.

Children of CATHARINA HANGJAS and JACOB ROMEIN are:

- i. MARIA JULIA AMALIA⁷ ROMEIN, b. Abt. 1877, Haarlem; d. 27 Nov 1948, Renkum; m. JAN WARMOLD ALINGH; b. Abt. 1870, Winschoten.
- ii. JACOBA ANTJE TJAKO ROMEIN, b. Abt. 1886, Haarlem; d. 20 May 1915; m. CHRISTOPH GEORGE SIGISMUND BEGEMANN, 20 May 1915, Haarlem; b. Abt. 1890, Tandjong Pandan.
- iii. CATHARINA ROMEIN, b. Abt. 1890, Haarlem; m. ALEXANDER CARLO FIORANI, 10 Feb 1916, Amsterdam; b. Abt. 1887, Den Haag.

29. JANSJE⁶ HANGJAS (*JACOB LEV⁵, LEVIE JOSEPH JOZALE⁴, JOSEPH JOZALE ABRAHAM HANGJAS³ TURFKRUIJER, LEVY JOEL HANGJAS², JOEL JOSEPH HANGJAS¹*) was born 1856 in Haarlem. She married WILLEM HOOIJER 19 May 1881 in Haarlem, son of CORNELIS HOOIJER and LENA SCHEFFER. He was born Abt. 1855 in Leeuwarden.

Children of JANSJE HANGJAS and WILLEM HOOIJER are:

- i. EMMA⁷ HOOIJER, b. Abt. 1875, Haarlem; m. JACOB PIETER KREB, 19 Apr 1906, Alkmaar; b. Abt. 1871, Beemster.
- ii. JANSJE HOOIJER, b. Abt. 1884, Haarlem; m. ARIJ SLUITER; b. Abt. 1883, Stad Almelo.
- iii. HENDRINA HOOIJER, b. Abt. 1894, Alkmaar; m. HERMANUS SCHOONHOVEN, 16 May 1916, Bergen; b. Abt. 1884, Alkmaar.

30. JOHANNES⁶ HANGJAS (*JACOB LEV⁵, LEVIE JOSEPH JOZALE⁴, JOSEPH JOZALE ABRAHAM HANGJAS³ TURFKRUIJER, LEVY JOEL HANGJAS², JOEL JOSEPH HANGJAS¹*) was born 1850 in Haarlem, and died 22 Oct 1927. He married TONIA ZWEERS 29 Jan 1880 in Rheden, daughter of GERRIT ZWEERS and BERENDIEN TEUNISSEN. She was born 1853 in Rheden, and died 10 Oct 1928 in Worth-Rheden.

Child of JOHANNES HANGJAS and TONIA ZWEERS is:

- i. JACOB HENRI⁷ HANGJAS, b. Abt. 1880, Haarlem; d. 08 Oct 1917, Bloemendaal; m. (1) GEERTJE SLOT, 18 May 1905, Haarlem; b. Abt. 1884, Purmerend; m. (2) ENA JOHANNA BLEI, Aft. 1906.

31. LOUIS MARINUS ANTONIUS⁶ HANGJAS (*MARCUS LEVI⁵, LEVIE JOSEPH JOZALE⁴, JOSEPH JOZALE ABRAHAM HANGJAS³ TURFKRUIJER, LEVY JOEL HANGJAS², JOEL JOSEPH HANGJAS¹*) was born 08 Mar 1853 in Leiden, and died 26 Sep 1912 in Haarlem. He married NEELTJE VAN DER WERFF 16 Jul 1876 in Zandvoort, daughter of GERRIT WERFF and WILLEMPJE GROENEVELD. She was born 16 Jul 1856 in Zandvoort, and died 16 Mar 1908 in Haarlem.

Children of LOUIS HANGJAS and NEELTJE WERFF are:

- i. GERRIT⁷ HANGJAS, d. 25 Dec 1923, Bergen op Zoom; m. JACOBA NOORDHUIZEN.
- ii. CAREL GERRIT HANGJAS, b. 18 Nov 1876, Zandvoort; d. 04 Nov 1908, Haarlem.
- iii. WILLEM HENNIE HANGJAS, b. 08 Jul 1878, Zandvoort; d. 21 Aug 1885, Haarlem.
- iv. LOUISA ANTONIA HANGJAS, b. Bet. 1886 - 1887, Haarlem; d. 22 May 1909, Bloemendaal.
- v. LOUIS MARINUS ANTONIUS HANGJAS, b. Abt. 1895, Haarlem; m. MARIA BAARS, 23 Dec 1925, Amsterdam; b. Abt. 1903, Amsterdam.
- vi. LOUISA ANTONIA HANGJAS, b. 1882, Haarlem; d. 21 Aug 1885, Haarlem.
- vii. DOODGEBOREN ZOON HANGJAS, b. 27 Oct 1888, Haarlem; d. 27 Oct 1888, Haarlem.
- viii. MARIA HELENA CAROLINA HANGJAS, b. Bet. 1879 - 1880, Haarlem; m. PIETER ZIPP, 18 May 1905, Haarlem; b. Bet. 1880 - 1881, Beverwijk.
- ix. LOUIS MARINUS ANTONIUS HANGJAS, b. Bet. Mar - Apr 1881, Haarlem; d. 10 Jun 1883, Haarlem.

32. CAREL JACOB⁶ HANGJAS (*MARCUS LEVI⁵, LEVIE JOSEPH JOZALE⁴, JOSEPH JOZALE ABRAHAM HANGJAS³ TURFKRUIJER, LEVY JOEL HANGJAS², JOEL JOSEPH HANGJAS¹*) was born 21 Sep 1855 in Rotterdam, and died 02 Jun 1896 in Haarlem. He married CORNELIA BOOGAART 24 Nov 1880 in Haarlem, daughter of JOHANNES BOOGAART and ELISABETH CORNET. She was born 20 Dec 1860 in Haarlem.

Children of CAREL HANGJAS and CORNELIA BOOGAART are:

- i. NEELTJE LOUISA⁷ HANGJAS, b. 1881.
- ii. DOODGEBOREN ZOON HANGJAS, b. 1882.

33. SAARTJE⁶ HANGJAS (*MOZES LEVI⁵, LEVIE JOSEPH JOZALE⁴, JOSEPH JOZALE ABRAHAM HANGJAS³ TURFKRUIJER, LEVY JOEL HANGJAS², JOEL JOSEPH HANGJAS¹*) was born Abt. 1842 in Haarlem, Nth Holland, Netherlands, and died 05 Mar 1908 in Rotterdam. She married (2) JACOB ABRAHAM YER Bef. 1876. He died Bef. 1886. She married (3) ISRAËL SCHAAP 10 Nov 1886 in Amsterdam, son of RUBEN SCHAAP and HESTER LEVIE. He died 21 May 1927 in Rotterdam.

Child of SAARTJE HANGJAS is:

56. i. JESAIA⁷ HANGJAS, b. 14 Sep 1862, Amsterdam; d. 11 Mar 1942, Amsterdam.

Children of SAARTJE HANGJAS and JACOB YER are:

- ii. ABRAHAM⁷ YER, b. Abt. 1876, Rotterdam; m. KAATJE STAD, 07 Oct 1896, Rotterdam; b. Abt. 1877.
- iii. JUDITH YER, b. 15 Dec 1878, Amsterdam; d. 16 Nov 1969, Rotterdam; m. MARCUS SPREEKMEESTER, 23 Dec 1896, Rotterdam; b. 30 Jul 1878, Rotterdam; d. 01 Feb 1943, Auschwitz.

Child of SAARTJE HANGJAS and ISRAËL SCHAAP is:

- iv. RACHEL SAARTJE⁷ SCHAAP, b. Abt. 1881, Amsterdam; d. 04 Oct 1916, Rotterdam; m. JACOB HERTOOG, 05 Nov 1902, Rotterdam; b. Abt. 1872, Frankfurt.

34. MARCUS JOSEPH⁶ HANGJAS (*JOSEPH MARCUS⁵, MARCUS MORDECHAI JOSEPH JOZALE HANGJAS⁴ TURFKRUYE, JOSEPH JOZALE ABRAHAM HANGJAS³ TURFKRUIJER, LEVY JOEL HANGJAS², JOEL JOSEPH HANGJAS¹*) was born 03 Jul 1839 in Haarlem, Nth Holland, Netherlands, and died 15 Apr 1898 in Leiden. He married (1) RIEKA NAAR 18 Dec 1872 in Haarlem, Nth Holland, Netherlands, daughter of JACOB NAAR and ESTHER MURSIA. She was born Abt. 1851 in Haarlem, Nth Holland, Netherlands. He married (2) BETJE PILLER 22 Oct 1891 in Leiden, daughter of ELKAN PILLER and HANNAH KOEKOEK. She was born 11 Feb 1857 in Gravenhage, Netherlands, and died 20 Mar 1943 in Sobibor.

Children of MARCUS HANGJAS and RIEKA NAAR are:

57. i. JUDIK⁷ HANGJAS, b. 30 Mar 1874, Haarlem, Nth Holland, Netherlands; d. 30 Sep 1937, Antwerpen.
- ii. ESTHER HANGJAS, b. Abt. 1875, Haarlem, Nth Holland, Netherlands; m. HARTOG BLITS, 26 Sep 1894, Amsterdam; b. Abt. 1875.

Children of MARCUS HANGJAS and BETJE PILLER are:

58. iii. ELKAN⁷ HANGJAS, b. 08 Oct 1893, Leiden; d. 31 Jan 1944, Auschwitz.
59. iv. JOSEPH MARCUS HANGJAS, b. 15 Apr 1898, Leiden; d. 31 Jan 1943, Monowitz.
60. v. HANNA HANGJAS, b. 23 Oct 1894, Leiden; d. 13 Mar 1943, Sobibor.
- vi. JOSEPH MARCUS HANGJAS, b. 16 Sep 1892, Leiden; d. 22 Mar 1893, Leiden.

35. SIMON⁶ HANGJAS (*JOSEPH MARCUS⁵, MARCUS MORDECHAI JOSEPH JOZALE HANGJAS⁴ TURFKRUYE, JOSEPH JOZALE ABRAHAM HANGJAS³ TURFKRUIJER, LEVY JOEL HANGJAS², JOEL JOSEPH HANGJAS¹*) was born 13 Aug 1857 in Haarlem, and died 16 Aug 1876. He married JUDIKJE MANHEIM 19 Mar 1873 in Haarlem, daughter of ABRAHAM MANHEIM and RACHEL WALLACH. She was born 13 Aug 1857 in Den Helder.

Children of SIMON HANGJAS and JUDIKJE MANHEIM are:

61. i. REGINA⁷ HANGJAS, b. 23 Oct 1875, Haarlem; d. 26 Oct 1942, Auschwitz.
- ii. JOSEPH HANGJAS, b. 26 Jan 1874, Haarlem; d. 28 May 1943, Sobibor; m. (1) DEBORA MARIANNE FRANK, 26 Jan 1874, Haarlem; b. 19 Jun 1879, Haarlem; d. 28 May 1943, Sobibor; m. (2) DEBORA MARIANNE FRANK, 07 Aug 1901, Zaandam; b. 1879, Haarlem.

36. SARA⁶ HANGJAS (*JOSEPH MARCUS⁵, MARCUS MORDECHAI JOSEPH JOZALE HANGJAS⁴ TURFKRUYE, JOSEPH JOZALE ABRAHAM HANGJAS³ TURFKRUIJER, LEVY JOEL HANGJAS², JOEL JOSEPH HANGJAS¹*) was born 12 Jul 1854 in Haarlem, Nth Holland, Netherlands, and died 23 Nov 1942 in Amsterdam, Netherlands. She married LEVIE KOSTER 11 Jun 1879 in Haarlem, son of WILLEM KOSTER and RACHEL POLAK. He was born 16 Feb 1856 in Hoorn, Netherlands, and died 12 Oct 1920 in Amsterdam, Netherlands.

Children of SARA HANGJAS and LEVIE KOSTER are:

- i. REGINA⁷ KOSTER, b. 16 Sep 1879, Haarlem, Nth Holland, Netherlands; d. 16 Jun 1884, Amsterdam, Netherlands.
- ii. HENRIETTE KOSTER, b. 02 Nov 1880, Amsterdam, Netherlands; d. 01 May 1882, Amsterdam, Netherlands.
62. iii. MARIANNE KOSTER, b. 10 Nov 1881, Amsterdam, Netherlands; d. 1936, Den Haag, Netherlands.
- iv. JOHANNA KOSTER, b. 05 Apr 1883.
63. v. WILLEM KOSTER, b. 03 Dec 1884, Amsterdam, Netherlands; d. 1945, Netherlands.
- vi. JOSEPH KOSTER, b. 10 Mar 1887, Amsterdam, Netherlands; d. 22 Apr 1887, Amsterdam, Netherlands.
- vii. SIMON KOSTER, b. 24 Jun 1888, Amsterdam, Netherlands; d. 11 May 1889, Amsterdam, Netherlands.
64. viii. MARCUS (MAX) KOSTER, b. 14 Apr 1890, Amsterdam, Netherlands; d. 03 Dec 1973, Bronx, New York.
- ix. JOSEPH KOSTER, b. 11 Nov 1893, Amsterdam, Netherlands; d. 1942, Polish Concentration Camp.
65. x. LEONARD KOSTER, b. 11 Nov 1896, Amsterdam, Netherlands; d. 11 Nov 1940, Amsterdam, Netherlands.
- xi. HENRIETTE KOSTER, b. 1898, Amsterdam, Netherlands; d. 1943, Polish Concentration Camp.

37. CORNELIA⁶ PAARDEBEK (*JANNETJE MARCUS⁵ HANGJAS, MARCUS MORDECHAI JOSEPH JOZALE HANGJAS⁴ TURFKRUYE, JOSEPH JOZALE ABRAHAM HANGJAS³ TURFKRUIJER, LEVY JOEL HANGJAS², JOEL JOSEPH HANGJAS¹*) was born Abt. 1850 in Haarlem. She married IZAAK WALLACH 01 Jul 1874 in Haarlem, son of SALAMON WALLACH and SARA VAN EMBDEN. He was born 06 Dec 1850 in Haarlem.

Children of CORNELIA PAARDEBEK and IZAAK WALLACH are:

- i. ANDRIES IZAAK⁷ WALLACH, b. 09 Jul 1871, Haarlem.
- ii. SALOMON WALLACH, b. 24 Jul 1876, Haarlem; d. 13 Mar 1877.
- iii. MOZES WALLACH, b. 27 Sep 1877, Haarlem.
- iv. SARA WALLACH, b. 12 Dec 1881, Haarlem.
- v. LEVI WALLACH, b. 07 Mar 1883, Haarlem; d. 22 Aug 1930, S-Gravenhage; m. ENGETJE DE GROOT, 18 Sep 1912, Amsterdam.
- vi. SALOMON WALLACH, b. 15 Sep 1884, Haarlem.
66. vii. HIJMAN (HERMAN) WALLACH, b. 19 Apr 1890, Haarlem; d. 19 Oct 1942, Katowice, Poland.
67. viii. JANSJE WALLACH, b. 15 Apr 1892, Haarlem; d. 22 Oct 1942, Auschwitz.

38. NAATJE⁶ PAARDEBEK (*JANNETJE MARCUS⁵ HANGJAS, MARCUS MORDECHAI JOSEPH JOZALE HANGJAS⁴ TURFKRUYE, JOSEPH JOZALE ABRAHAM HANGJAS³ TURFKRUIJER, LEVY JOEL HANGJAS², JOEL JOSEPH HANGJAS¹*) was born Abt. 1851 in Haarlem. She married (1) SAMUEL VLESSING 09 Dec 1874, son of HARTOG VLESSING and SCHOONTJE HANGJAS. He was born Abt. 1850 in Texel, Noord Holland, Netherlands, and died Bef. 1888. She married (2) NATHAN SPIER 07 Jan 1888 in Haarlem. He was born 23 Mar 1860 in Arnhem, Gelderland, Netherlands, and died 20 Jan 1941 in Arnhem, Gelderland, Netherlands.

Children of NAATJE PAARDEBEK and SAMUEL VLESSING are:

- i. HARTOG⁷ VLESSING, b. 16 Nov 1875, Haarlem, Nth Holland, Netherlands; d. 10 May 1877, Haarlem, Nth Holland, Netherlands.
- ii. JANSJE VLESSING, b. 16 Dec 1879, Haarlem, Nth Holland, Netherlands; d. 11 Apr 1880, Haarlem, Nth Holland, Netherlands.
- iii. MIETJE VLESSING, b. 06 Apr 1885, Haarlem, Nth Holland, Netherlands; d. 24 May 1889, Haarlem, Nth Holland, Netherlands.
- iv. MOSES VLESSING, b. Abt. 1877, Haarlem, Nth Holland, Netherlands; m. JOHANNA KOK, 30 Jun 1921; b. Abt. 1879.

39. SAMUEL⁶ VLESSING (*SCHOONTJE SJEINE⁵ HANGJAS, MARCUS MORDECHAI JOSEPH JOZALE HANGJAS⁴ TURFKRUYE, JOSEPH JOZALE ABRAHAM HANGJAS³ TURFKRUIJER, LEVY JOEL HANGJAS², JOEL JOSEPH HANGJAS¹*) was born Abt. 1850 in Texel, Noord Holland, Netherlands, and died Bef. 1888. He married NAATJE PAARDEBEK 09 Dec 1874, daughter of MOZES PAARDEBEK and JANNETJE HANGJAS. She was born Abt. 1851 in Haarlem.

Children are listed above under (38) Naatje Paardebek.

40. IZAAK JOSEF⁶ HANGJAS (*MAARTJE MARCUS⁵, MARCUS MORDECHAI JOSEPH JOZALE HANGJAS⁴ TURFKRUYE, JOSEPH JOZALE ABRAHAM HANGJAS³ TURFKRUIJER, LEVY JOEL HANGJAS², JOEL JOSEPH HANGJAS¹*) was born Abt. 1846 in Haarlem. He married (1) SOPHIA VAN KAMPE 03 Mar 1869 in Haarlem, daughter of CORNELIS VAN KAMPE and CATHARINA STOUTENBEEK. She was born Abt. 1844 in Haarlem, and died Bef. 1878. He married (2) JOHANNA MARIA GODEFROOIJ 05 Jun 1878 in Haarlem, daughter of JOHANNES GODEFROOIJ and JOHANNA JANSEN. She was born Abt. 1860 in 5 June 1878.

Children of IZAAK HANGJAS and JOHANNA GODEFROOIJ are:

68. i. IZAAK JOSEF⁷ HANGJAS, b. Abt. 1879, Haarlem.
- ii. MARETJE HANGJAS, b. Abt. 1885, Haarlem; d. 18 Jan 1927, Bloemendaal.
- iii. WILHELMUS HANGJAS, b. Abt. 1886, Haarlem; m. (1) JANSJE VEENINGS, 05 May 1909, Haarlem; m. (2) JANSJE BLOMMAERT, 20 Aug 1925, Amsterdam; b. Abt. 1891, Haarlem.
- iv. CORNELIS HANGJAS, b. 31 Mar 1888, Haarlem; d. 09 Jul 1889.
- v. JOHANNA MARIA HANGJAS, b. Abt. 1890, Haarlem; m. (1) SIEGER NOORDENBOS, 13 Jul 1910, Amsterdam; b. Abt. 1889, Amsterdam; m. (2) ANTHONIE LAGERWEIJ, 07 Aug 1919, Angerlo; b. Abt. 1889, Angerlo.

41. BETJE⁶ DUVEEN (*JOSEPH⁵, ENOCH ELKAN JOSEPH⁴, JOSEPH MOSES HANGJAS³, MOSES JOEL HANGJAS² TURFKRUIJER, JOEL JOSEPH HANGJAS¹*) was born 04 Nov 1850 in Meppel, and died 1918. She married (1) HENRI JACOB HANGJAS-DUVEEN 05 Dec 1872 in Haarlem, son of JACOB HANGJAS and JOHANNA MIEZERUS. He was born 1848 in Haarlem, Nth Holland, Netherlands, and died 1877 in Haarlem, Nth Holland, Netherlands. She married (2) JOZEF MOZES DUVEEN 1883, son of MOZES DUVEEN and SAARTJE VECHT. He was born 17 Feb 1853 in Zwolle.

Children are listed above under (27) Henri Jacob Hangjas-Duveen.

42. JOEL JOSEPH⁶ DUVEEN (*JOSEPH⁵, ENOCH ELKAN JOSEPH⁴, JOSEPH MOSES HANGJAS³, MOSES JOEL HANGJAS² TURFKRUIJER, JOEL JOSEPH HANGJAS¹*) was born 30 Apr 1843 in Meppel, and died 09 Nov 1908 in Hyeres, France. He married ROSETTA BARNETT. She was born 1851, and died 1922.

Children of JOEL DUVEEN and ROSETTA BARNETT are:

69. i. ESTHER⁷ DUVEEN, b. 07 Nov 1870, Hull; d. 22 Nov 1949.
70. ii. JOSEPH JOEL DUVEEN, b. 14 Oct 1869, Hull; d. 1939.
71. iii. CHARLES JOEL DUVEEN, b. 02 Dec 1871, Kingston Upon Hull, Yorkshire, England; d. 1940.
72. iv. LOUIS DUVEEN, b. 21 Feb 1874, Hull; d. 04 Mar 1920.
73. v. EDWARD JOEL DUVEEN, b. 20 Mar 1875, Hull; d. 1946.
74. vi. BENJAMIN JOEL DUVEEN, b. 07 Apr 1876; d. 1959, New York.
- vii. HENRY DUVEEN, b. 03 Nov 1878; d. 1963; m. PHYLLIS HOPE STEVENSON, 1911.
- viii. ANNETTE EVELINE DUVEEN, b. 1879; d. 1954; m. VICTOR A WALKER, 1918.
- ix. ERNEST DUVEEN, b. 10 May 1883; d. 1939, Paris.
- x. EVALINE DUVEEN, b. 1884; d. 1944; m. ARTHUR ABRAHAMS.
75. xi. FLORENCE DUVEEN, b. 1886; d. 1945.
76. xii. JOHN JOEL DUVEEN, b. 13 Jan 1873, Hull; d. 15 Oct 1951.

43. HENRY HENOCHE JOSEPH⁶ DUVEEN (*JOSEPH⁵, ENOCH ELKAN JOSEPH⁴, JOSEPH MOSES HANGJAS³, MOSES JOEL HANGJAS² TURFKRUIJER, JOEL JOSEPH HANGJAS¹*) was born 26 Oct 1854 in Meppel, and died 1915. He married DORA FALCKE 1884 in London.

Child of HENRY DUVEEN and DORA FALCKE is:

- i. GEFREY⁷ DUVEEN, b. 1886.

44. EVA⁶ DUVEEN (*MOZES⁵, ENOCH ELKAN JOSEPH⁴, JOSEPH MOSES HANGJAS³, MOSES JOEL HANGJAS² TURFKRUIJER, JOEL JOSEPH HANGJAS¹*) was born 24 Mar 1843 in Zwolle, and died 01 Apr 1891 in Apeldoorn. She married SIMON DE JONG 06 Jun 1867 in Zwolle. He was born 06 Apr 1840 in Epe, Gelderland.

Children of EVA DUVEEN and SIMON DE JONG are:

- i. SALOMON⁷ DE JONG, m. SARA DE LEEUW, 26 Mar 1908, Groningen; b. 28 Sep 1880, Groningen; d. 25 Jan 1943, Auschwitz.
77. ii. ROOSJE DE JONG, b. 17 Jun 1868, Apeldoorn; d. 23 Nov 1942, Auschwitz.
78. iii. SAARTJE DE JONG, b. 08 Nov 1871, Apeldoorn; d. 12 Jan 1945, Bergen Belsen.
- iv. HESTER DE JONG, b. 1877; m. SALOMON ISRAEL THEMANS, 20 Jun 1900.

45. HEIMAN MOZES⁶ DUVEEN (*MOZES⁵, ENOCH ELKAN JOSEPH⁴, JOSEPH MOSES HANGJAS³, MOSES JOEL HANGJAS² TURFKRUIJER, JOEL JOSEPH HANGJAS¹*) was born 19 Apr 1845 in Zwolle. He married (1) ANTJE-AALTJE VERDUN 15 Dec 1874. She was born 1845 in Dieman, and died 16 Apr 1875 in Zwolle. He married (2) LEENTJE DE LEEUW 09 Dec 1875 in Winschoten, daughter of AARON DE LEEUW and SARA ENGERS. She was born 15 Aug 1847 in Winschoten.

Children of HEIMAN DUVEEN and LEENTJE DE LEEUW are:

- i. MAURITS⁷ DUVEEN, b. 12 Aug 1877, Groningen; d. 15 Dec 1942, Auschwitz; m. (1) GRACIA JESSURUN LOBO; b. 18 Mar 1877, Amsterdam; d. 15 Dec 1942, Auschwitz; m. (2) SOPHIA DANNEBOOM; b. 06 Jul 1893, Zwolle.
79. ii. SARA-SAARTJE DUVEEN, b. 04 Oct 1878, Groningen; d. 08 Oct 1942, Auschwitz.
80. iii. REINA-REINTJE DUVEEN, b. 02 Oct 1879, Groningen; d. 19 Nov 1943, Auschwitz.
- iv. ADOLF DUVEEN, b. 19 Oct 1880, Groningen; d. 19 Nov 1943, Auschwitz; m. MINNA ROSENBERG; b. 1882, Atteln; d. 19 Nov 1943, Auschwitz.
81. v. MARCUS DUVEEN, b. 25 Aug 1882, Groningen; d. 1970, Hilversum.
- vi. SOPHIA DUVEEN, b. 09 Feb 1884.
82. vii. HERMAN DUVEEN, b. 25 Feb 1885, Groningen; d. 22 May 1944, Auschwitz.
83. viii. SOPHIA-FIE DUVEEN, b. 06 Sep 1887, Groningen; d. 28 May 1943, Sobihor.

46. HENOCHE MOZES⁶ DUVEEN (*MOZES⁵, ENOCH ELKAN JOSEPH⁴, JOSEPH MOSES HANGJAS³, MOSES JOEL HANGJAS² TURFKRUIJER, JOEL JOSEPH HANGJAS¹*) was born 01 Apr 1848 in Zwolle. He married HANNA KAN.

Children of HENOCHE DUVEEN and HANNA KAN are:

84. i. JETTE⁷ DUVEEN, b. 25 Oct 1890; d. 1954, Even Yehuda, Israel.
85. ii. SOPHIA DUVEEN.
- iii. JULIUS DUVEEN, b. 13 Mar 1876, Amsterdam; d. 28 Jan 1944, Auschwitz.
- iv. JAAP-JACOB DUVEEN, b. 08 Jan 1884, Amsterdam; d. 21 May 1943, Sobihor.
86. v. HARTOG DUVEEN, b. 1885; d. 1944, Norwich.
87. vi. ABRAHAM-ABIE MOZES, b. 22 Mar 1893, Amsterdam; d. 07 Aug 1942, Auschwitz.

47. IZAAK⁶ DUVEEN (*MOZES⁵, ENOCH ELKAN JOSEPH⁴, JOSEPH MOSES HANGJAS³, MOSES JOEL HANGJAS² TURFKRUIJER, JOEL JOSEPH HANGJAS¹*) was born 15 May 1851 in Zwolle. He married LEENTJE SPANJAR 1879 in Nijkerk, Gelderland, Netherlands. She was born 24 Nov 1857 in Nijkerk.

Children of IZAAK DUVEEN and LEENTJE SPANJAR are:

- i. SAARTJE⁷ DUVEEN, b. 03 Nov 1880, Zwolle; m. DE MESQUITA J. BUENODE, 1901, Zwolle.
- ii. CLARA DUVEEN, b. 21 Apr 1882, Zwolle.
- iii. REINTJE DUVEEN, b. 22 Jun 1883, Zwolle; d. 02 Jul 1943, Sobihor.
- iv. MOZES DUVEEN, b. 23 Aug 1885, Zwolle; d. 14 Mar 1886, Zwolle.
- v. HEINTJE DUVEEN, b. 19 Feb 1887, Zwolle; m. J. H. L. BROKMEIJER, 1908, Zwolle.

48. WOLF⁶ DUVEEN (*MOZES⁵, ENOCH ELKAN JOSEPH⁴, JOSEPH MOSES HANGJAS³, MOSES JOEL HANGJAS² TURFKRUIJER, JOEL JOSEPH HANGJAS¹*) was born 26 Feb 1855 in Zwolle. He married REBEKKA ENGERS 07 Jan 1880 in Winschoten, daughter of FREERK ENGERS and HENDERINA POLAK. She was born 03 Mar 1852 in Winschoten, and died 25 Dec 1916 in Winschoten.

Children of WOLF DUVEEN and REBEKKA ENGERS are:

- i. MOZES⁷ DUVEEN, b. 20 Oct 1880, Zwolle.
- ii. FREERIK DUVEEN, b. 09 Feb 1882, Winschoten; d. 02 Apr 1945, Bergen Belsen; m. JOHANNA WAGENAAR.
88. iii. SIMSON DUVEEN, b. 30 Jun 1883, Winschoten; d. 12 Feb 1943, Auschwitz.
- iv. HERMAN DUVEEN, b. 26 Aug 1884, Winschoten; d. 26 Oct 1942, Auschwitz.
- v. HENDRINA DUVEEN, b. 14 Nov 1885, Winschoten; d. 28 Jan 1944, Auschwitz; m. MICHAEL WAGENAAR; b. 14 Nov 1885, Wildervank.
- vi. IZAK DUVEEN, b. 14 Nov 1885, Winschoten; d. 09 Jan 1886, Winschoten.
- vii. SARA DUVEEN, b. 18 Jan 1887, Winschoten; d. 20 Mar 1943, Sobihor; m. LIEPMAN KOSSES; b. 09 Nov 1882, Bellingwolde; d. 20 Mar 1943, Sobihor.
- viii. IZAAK DUVEEN, b. 25 Sep 1888, Winschoten; m. HENRIETTE DE HAAN; b. 14 Nov 1890, Noordhorn.

Generation No. 7

49. EDWIN (EDDIE) LISTER⁷ HANDRICKS (*NORMAN (NORRIE) FREDERICK JAMES⁶, JOZEF LEVI⁵, LEVIE JOSEPH JOZALE⁴ HANGJAS, JOSEPH JOZALE ABRAHAM HANGJAS³ TURFKRUIJER, LEVY JOEL HANGJAS², JOEL JOSEPH HANGJAS¹*) was born 05 Mar 1926 in Lister Hospital, Riverside Road, Gisborne, and died 01 May 2011 in Middlemore Hospital, Auckland. He married NORMA MARGARET LOUISA HARRIS 31 Oct 1953 in 2:00pm St Davids Church, Naenae, Wellington, daughter of FREDERICK HARRIS and MARGARET VALENTINE. She was born 12 Jan 1930 in Alexandra Nursing Home, 28 Hanson Street, Newtown, Wellington, and died 11 Dec 2011 in St Andrews Hospital, Glendowie, Auckland.

Children of EDWIN HANDRICKS and NORMA HARRIS are:

89. i. IAN LISTER⁸ HANDRICKS, b. 06 Jul 1955, At Home, 9 Farringdon St, Glen Innes, Auckland.
90. ii. LYNETTE MARGARET HANDRICKS, b. 02 Jul 1957, At Home, 9 Farringdon St, Glen Innes, Auckland.
91. iii. GLENN PETER HANDRICKS, b. 03 Mar 1966, Middlemore Hospital, Auckland.

50. ROBERT HARRY⁷ HANDRICKS (*NORMAN (NORRIE) FREDERICK JAMES⁶, JOZEF LEVI⁵, LEVIE JOSEPH JOZALE⁴ HANGJAS, JOSEPH JOZALE ABRAHAM HANGJAS³ TURFKRUIJER, LEVY JOEL HANGJAS², JOEL JOSEPH HANGJAS¹*) was born 08 Apr 1920 in Gisborne, and died 07 Aug 2007 in Dargaville. He married KATHLEEN GLADYS MAY HOWELLS 1956, daughter of STEPHEN HOWELLS and MAUD YOUNG. She was born 27 Jun 1927 in NZ, and died 19 Oct 1989 in Auckland.

Children of ROBERT HANDRICKS and KATHLEEN HOWELLS are:

92. i. LINDA MAY⁸ HANDRICKS, b. 11 Sep 1962.
- ii. DIANE FRANCES HANDRICKS, b. 02 May 1960; m. LIONEL LOZA.

51. NORMAN LESLIE⁷ HANDRICKS (*NORMAN (NORRIE) FREDERICK JAMES⁶, JOZEF LEVI⁵, LEVIE JOSEPH JOZALE⁴ HANGJAS, JOSEPH JOZALE ABRAHAM HANGJAS³ TURFKRUIJER, LEVY JOEL HANGJAS², JOEL JOSEPH HANGJAS¹*) was born 19 Sep 1915 in Wellington, and died 27 Jan 2004 in Whakatane. He married PEGGY DOREEN MOSEN 1943, daughter of JAMES MOSEN and BEATRICE BOWLES. She was born 17 Apr 1923 in Masterton, and died 30 Jun 2014 in Whakatane.

Children of NORMAN HANDRICKS and PEGGY MOSEN are:

93. i. PAUL⁸ HANDRICKS, b. 23 Mar 1944, Masterton.
- ii. SHIRLEY HANDRICKS, b. 30 Jan 1959.

52. DOUGLAS HUBERT NELSON⁷ HANDRICKS (*NORMAN (NORRIE) FREDERICK JAMES⁶, JOZEF LEVI⁵, LEVIE JOSEPH JOZALE⁴ HANGJAS, JOSEPH JOZALE ABRAHAM HANGJAS³ TURFKRUIJER, LEVY JOEL HANGJAS², JOEL JOSEPH HANGJAS¹*) was born 25 Aug 1917 in Nelson, and died 09 May 1981 in Sydney. He met (1) MAUVA BERYL CLEMENTS 1940, daughter of EDGAR CLEMENTS and VIOLET CLARIDGE. She was born 22 Jul 1921 in Nelson, New Zealand, and died Jul 1968 in Akron NY USA. He married (2) FREDA BARBARA SPILSBURY 1946 in New Zealand, daughter of JOHN SPILSBURY and EDNA THORNE. She was born 03 Apr 1922 in St Helens Hospital, Auckland, New Zealand, and died Mar 1989 in Sydney, New South Wales, Australia.

Children of DOUGLAS HANDRICKS and MAUVA CLEMENTS are:

94. i. YVONNE IRENE⁸ HANDRICKS, b. 29 Dec 1940, Auckland.
- ii. ? HANDRICKS, b. 29 Dec 1940, Auckland; d. 29 Dec 1940, Auckland.

53. MORRIS CEDRIC CLARE⁷ JOSEPH (*SARAH ELIZABET (LILY)⁶ HANDRICKS, JOZEF LEVI⁵, LEVIE JOSEPH JOZALE⁴ HANGJAS, JOSEPH JOZALE ABRAHAM HANGJAS³ TURFKRUIJER, LEVY JOEL HANGJAS², JOEL JOSEPH HANGJAS¹*) was born 08 Dec 1890 in Ballarat, Victoria, Australia, and died 07 Aug 1972 in Windsor, Victoria. He married HANNAH WINIFRED COLEMAN 23 Jun 1918 in London England, daughter of DAVID COLEMAN and ISABEL SLUIS. She was born 30 Sep 1897 in Paddington, London, England, and died 15 Apr 1976 in Melbourne.

Children of MORRIS JOSEPH and HANNAH COLEMAN are:

95. i. JOSEPHINE⁸ JOSEPH, b. 01 Oct 1920.
96. ii. BERESFORD (BERRY) CLARE JOSEPH, b. 14 Apr 1922; d. 13 Mar 2007.
97. iii. DAVID LEOPOLD JOSEPH, b. 13 Feb 1927.
98. iv. NATHAN COLEMAN JOSEPH, b. 12 Sep 1930.
99. v. ELIZABETH ISOBEL JOSEPH, b. 22 Jun 1932.
100. vi. VALERIE VIOLET JOSEPH, b. 15 Jan 1934.

54. IRIS VERA ISABELLE⁷ TOMPSON (*AMELIA (MILLIE) JANE⁶ HANDRICKS, JOZEF LEVI⁵, LEVIE JOSEPH JOZALE⁴ HANGJAS, JOSEPH JOZALE ABRAHAM HANGJAS³ TURFKRUIJER, LEVY JOEL HANGJAS², JOEL JOSEPH HANGJAS¹*) was born 19 Sep 1901 in "Paynesville", Shenton Rd., Claremont, and died 30 Aug 1981 in Sir Charles Gairdner Hospital, Nedlands, Perth. She married HUBERT D'ESTERRE MINCHIN 03 Sep 1921 in Perth, WA, son of WILLIAM MINCHIN and FLORENCE HENNIKER. He was born 19 Oct 1896 in Camberwell, Victoria, and died 14 Jul 1974 in Sir Charles Gairdner Hospital, Nedlands, Perth.

Children of IRIS TOMPSON and HUBERT MINCHIN are:

101. i. RONALD D'ESTERRE⁸ MINCHIN, b. 15 Jan 1923, Perth, Western Australia, Australia.
102. ii. HUBERT BRIAN MINCHIN, b. 21 Sep 1924, Perth, Western Australia, Australia.
103. iii. WILLIAM PENN MINCHIN, b. 06 Apr 1927, Perth, Western Australia, Australia.
104. iv. ROSS MINCHIN, b. 29 Dec 1936, Perth.
105. v. IAN HUGH MINCHIN, b. 28 Nov 1938, Perth.

55. CLARENCE (CLARY) ALBERT ARTHUR LESLIE⁷ HANDRICKS (*ARTHUR WILLIAM⁶, JOZEF LEVI⁵, LEVIE JOSEPH JOZALE⁴ HANGJAS, JOSEPH JOZALE ABRAHAM HANGJAS³ TURFKRUIJER, LEVY JOEL HANGJAS², JOEL JOSEPH HANGJAS¹*) was born 22 Nov 1901 in at his parent's residence 82 Charles street, West Perth, and died 16 Apr 1971 in Mt Lawley, Perth. He married (1) MAUD EDNA BOESSER 1922, daughter of FERDINAND BOESSER and MAUDE WALDON. She was born 1905 in Perth, Western Australia, Australia, and died 04 Jun 1989 in at her residence 57 Lanark St. Coolbinia, Perth. He married (2) VIOLET MAY JACKSON 08 Apr 1939 in Wesley Church, Perth, daughter of HARRY JACKSON. She was born 1917, and died 21 Aug 1988 in Cottage Hospice, Shenton Park, Perth.

Child of CLARENCE HANDRICKS and MAUD BOESSER is:

- i. ALBERT EGERTON WAYNE⁸ HANDRICKS, b. 08 Dec 1922, Perth; d. 22 Jul 1994, Mt Lawley, Perth; m. GWENYTH MARIA CHENEY.

56. JESAIA⁷ HANGJAS (*SAARTJE⁶, MOZES LEVI⁵, LEVIE JOSEPH JOZALE⁴, JOSEPH JOZALE ABRAHAM HANGJAS³ TURFKRUIJER, LEVY JOEL HANGJAS², JOEL JOSEPH HANGJAS¹*) was born 14 Sep 1862 in Amsterdam, and died 11 Mar 1942 in Amsterdam. He married KLAARTJE SCHELVIS 30 Dec 1896 in Rotterdam, daughter of LEENDERT SCHELLEVIS and GRIETJE ROEPER. She was born Abt. 1875 in Amsterdam, and died 1939.

Children of JESAIA HANGJAS and KLAARTJE SCHELVIS are:

106. i. ISRAEL LEENDERT⁸ HANGJAS, b. 03 Jun 1897, Amsterdam; d. 16 Apr 1943, Sobibor.
107. ii. ABRAHAM HANGJAS, b. 27 Sep 1898, Amsterdam; d. 31 Mar 1944, Auschwitz.
108. iii. MOSES HANGJAS, b. 13 Jun 1901, Amsterdam; d. 13 Mar 1943, Sobibor.
- iv. SARA HANGJAS, b. 23 Jul 1903, Amsterdam; d. 21 Oct 1903, Amsterdam.
109. v. HARTOG HANGJAS, b. 03 Dec 1904, Amsterdam; d. 31 Jan 1943, Monowitz.
110. vi. ANNA HANGJAS, b. 09 Apr 1907, Amsterdam; d. 23 Apr 1943, Sobibor.
- vii. SAMUEL HANGJAS, b. 27 Sep 1911, Amsterdam; d. 24 Nov 1915, Amsterdam.

57. JUDIK⁷ HANGJAS (*MARCUS JOSEPH⁶, JOSEPH MARCUS⁵, MARCUS MORDECHAI JOSEPH JOZALE HANGJAS⁴ TURFKRUYE, JOSEPH JOZALE ABRAHAM HANGJAS³ TURFKRUIJER, LEVY JOEL HANGJAS², JOEL JOSEPH HANGJAS¹*) was born 30 Mar 1874 in Haarlem, Nth Holland, Netherlands, and died 30 Sep 1937 in Antwerpen. She married MORDECHAI VIEIJRA 27 Dec 1896 in Zaandam, son of DAVID VIEIJRA and REBECCA PIEMENTEL. He was born 10 Jul 1870 in Amsterdam, and died 1944 in Deurne.

Children of JUDIK HANGJAS and MORDECHAI VIEIJRA are:

- i. REBECCA⁸ VIEIJRA, b. 23 Oct 1903, Amsterdam; d. 11 Dec 1903, Amsterdam.
- ii. RIEKE VIEIJRA, b. 27 Feb 1905, Amsterdam; d. 12 Sep 1998, Antwerpen; m. HIJMAN (HENRI) SALOMON; b. 1905, Amsterdam; d. 24 Apr 1974, Antwerpen.
- iii. REBECCA VIEIJRA, b. 27 Jul 1907, Antwerpen; d. 11 Sep 1942, Auschwitz; m. ISIDOR FRANSMAN, 09 Mar 1904, Amsterdam; b. 09 Mar 1904, Amsterdam; d. 04 Sep 1942, Auschwitz.
111. iv. DAVID VIEIJRA, b. 23 Sep 1909, Antwerpen; d. 11 Sep 1942, Auschwitz.

58. ELKAN⁷ HANGJAS (*MARCUS JOSEPH⁶, JOSEPH MARCUS⁵, MARCUS MORDECHAI JOSEPH JOZALE HANGJAS⁴ TURFKRUYE, JOSEPH JOZALE ABRAHAM HANGJAS³ TURFKRUIJER, LEVY JOEL HANGJAS², JOEL JOSEPH HANGJAS¹*) was born 08 Oct 1893 in Leiden, and died 31 Jan 1944 in Auschwitz. He married (1) ELISABETH CATHARINA VAN DER HAM 26 May 1920 in Gravenhage, daughter of HIJMAN HAM and SUSANNA FULDAUER. She was born 07 Jan 1895 in Gravenhage. He married (2) SARAH HILDEGARD LACHS 20 May 1935 in Leiden, daughter of NATHAN LACHS and OLGA SAMUEL. She was born 10 May 1905 in Hochkirchen, Nörvenich, and died 26 Feb 1943 in Auschwitz.

Child of ELKAN HANGJAS and ELISABETH HAM is:

- i. LIESBETH SUSANNA⁸ HANGJAS.

59. JOSEPH MARCUS⁷ HANGJAS (*MARCUS JOSEPH⁶, JOSEPH MARCUS⁵, MARCUS MORDECHAI JOSEPH JOZALE HANGJAS⁴ TURFKRUYE, JOSEPH JOZALE ABRAHAM HANGJAS³ TURFKRUIJER, LEVY JOEL HANGJAS², JOEL JOSEPH HANGJAS¹*) was born 15 Apr 1898 in Leiden, and died 31 Jan 1943 in Monowitz. He married (1) SARA BOAS. She was born Abt. 1900, and died 1939. He married (2) CATHARINA AKKER Aft. 1939. She was born 07 Oct 1905 in Antwerpen, and died 12 Oct 1942 in Auschwitz.

Child of JOSEPH HANGJAS and SARA BOAS is:

- i. ELISABETH JEANETTE⁸ HANGJAS, b. 03 Jan 1928, Den Haag; d. 12 Oct 1942, Monowitz.

60. HANNA⁷ HANGJAS (*MARCUS JOSEPH⁶, JOSEPH MARCUS⁵, MARCUS MORDECHAI JOSEPH JOZALE HANGJAS⁴ TURFKRUYE, JOSEPH JOZALE ABRAHAM HANGJAS³ TURFKRUIJER, LEVY JOEL HANGJAS², JOEL JOSEPH HANGJAS¹*) was born 23 Oct 1894 in Leiden, and died 13 Mar 1943 in Sobibor. She married JACOB BLITZ 16 Jun 1920 in Leiden. He was born 13 Apr 1883 in Amsterdam, and died 13 Mar 1943 in Sobibor.

Child of HANNA HANGJAS and JACOB BLITZ is:

- i. ALICE⁸ BLITZ, b. 18 Jul 1923, Leiden; d. 26 Mar 1943, Sobibor.

61. REGINA⁷ HANGJAS (*SIMON⁶, JOSEPH MARCUS⁵, MARCUS MORDECHAI JOSEPH JOZALE HANGJAS⁴ TURFKRUYE, JOSEPH JOZALE ABRAHAM HANGJAS³ TURFKRUIJER, LEVY JOEL HANGJAS², JOEL JOSEPH HANGJAS¹*) was born 23 Oct 1875 in Haarlem, and died 26 Oct 1942 in Auschwitz. She married MEIJER TURFKRUIJER 04 Jan 1899 in Amsterdam, son of MEIJER TURFKRUIJER and FLORA AAP. He was born 20 Aug 1875 in London, and died 26 Oct 1942 in Auschwitz.

Children of REGINA HANGJAS and MEIJER TURFKRUIJER are:

- i. FLORA⁸ TURFKRUIJER, b. 15 Jun 1900, Amsterdam; d. 28 May 1943, Sobibor; m. ABRAHAM ZADOK PARSER, 13 Dec 1923, Amsterdam; b. 05 Oct 1899, Amsterdam; d. 28 May 1943, Sobibor.
- ii. HENRICA TURFKRUIJER.

62. MARIANNE⁷ KOSTER (*SARA⁶ HANGJAS, JOSEPH MARCUS⁵, MARCUS MORDECHAI JOSEPH JOZALE HANGJAS⁴ TURFKRUYE, JOSEPH JOZALE ABRAHAM HANGJAS³ TURFKRUIJER, LEVY JOEL HANGJAS², JOEL JOSEPH HANGJAS¹*) was born 10 Nov 1881 in Amsterdam, Netherlands, and died 1936 in Den Haag, Netherlands. She married EDMOND RAYMOND ISAAC, son of JACQUES ISAAC and ANNA CANTHER. He was born Abt. 1886 in Herstal.

Children of MARIANNE KOSTER and EDMOND ISAAC are:

- i. JACQUES⁸ ISAAC, b. 1920.
- ii. LOUIS ISAAC, b. 1923.
- iii. RENEE ISAAC, b. 1928.

63. WILLEM⁷ KOSTER (*SARA⁶ HANGJAS, JOSEPH MARCUS⁵, MARCUS MORDECHAI JOSEPH JOZALE HANGJAS⁴ TURFKRUYE, JOSEPH JOZALE ABRAHAM HANGJAS³ TURFKRUIJER, LEVY JOEL HANGJAS², JOEL JOSEPH HANGJAS¹*) was born 03 Dec 1884 in Amsterdam, Netherlands, and died 1945 in Netherlands. He married MARIANNE LOUISE (JANNY) VAN DER HAM 22 Oct 1919 in Den Haag. She was born 10 May 1896 in The Hague, Netherlands, and died 1985 in Amsterdam, Netherlands.

Children of WILLEM KOSTER and MARIANNE HAM are:

- i. SONJA S⁸ KOSTER, b. 31 Jan 1921.
- ii. SUZANNE KOSTER.

64. MARCUS (MAX)⁷ KOSTER (*SARA⁶ HANGJAS, JOSEPH MARCUS⁵, MARCUS MORDECHAI JOSEPH JOZALE HANGJAS⁴ TURFKRUYE, JOSEPH JOZALE ABRAHAM HANGJAS³ TURFKRUIJER, LEVY JOEL HANGJAS², JOEL JOSEPH HANGJAS¹*) was born 14 Apr 1890 in Amsterdam, Netherlands, and died 03 Dec 1973 in Bronx, New York. He married ESTHER DUITZ 29 Feb 1920 in Brooklyn, NY. She was born 11 May 1891 in Amsterdam, Netherlands, and died 03 Jul 1979 in Bronx, New York.

Children of MARCUS KOSTER and ESTHER DUITZ are:

- i. LEWIS WILLEM⁸ KOSTER.
- ii. HENRY JOHN KOSTER.

65. LEONARD⁷ KOSTER (*SARA⁶ HANGJAS, JOSEPH MARCUS⁵, MARCUS MORDECHAI JOSEPH JOZALE HANGJAS⁴ TURFKRUYE, JOSEPH JOZALE ABRAHAM HANGJAS³ TURFKRUIJER, LEVY JOEL HANGJAS², JOEL JOSEPH HANGJAS¹*) was born 11 Nov 1896 in Amsterdam, Netherlands, and died 11 Nov 1940 in Amsterdam, Netherlands. He married MARIANNE (MARIETJE) DOTSCH 22 Apr 1925, daughter of DAVID DOTSCH and HANNA DE BRUIN. She was born 24 Apr 1901 in Amsterdam, Netherlands, and died 14 Jul 1986 in Utrecht, Netherlands.

Child of LEONARD KOSTER and MARIANNE DOTSCH is:

- i. LOUISE SONJA (WEIS)⁸ KOSTER, b. 12 Aug 1926.

66. HIJMAN (HERMAN)⁷ WALLACH (*CORNELIA⁶ PAARDEBEK, JANNETJE MARCUS⁵ HANGJAS, MARCUS MORDECHAI JOSEPH JOZALE HANGJAS⁴ TURFKRUYE, JOSEPH JOZALE ABRAHAM HANGJAS³ TURFKRUIJER, LEVY JOEL HANGJAS², JOEL JOSEPH HANGJAS¹*) was born 19 Apr 1890 in Haarlem, and died 19 Oct 1942 in Katowice, Poland. He married FROUKJE VAN ESSO 06 Apr 1913 in Groningen. She was born 10 Sep 1890 in Groningen, and died 03 Sep 1943 in Katowice, Poland.

Children of HIJMAN WALLACH and FROUKJE VAN ESSO are:

- i. ISIDOOR⁸ WALLACH, b. 25 Mar 1914.
- ii. ROSETTA WALLACH, b. 04 Jun 1918.
- iii. CORRIE WALLACH, b. 05 Jun 1920.
- iv. LEO WALLACH, b. 07 Aug 1922.
- v. JANSJE WALLACH.

67. JANSJE⁷ WALLACH (*CORNELIA⁶ PAARDEBEK, JANNETJE MARCUS⁵ HANGJAS, MARCUS MORDECHAI JOSEPH JOZALE HANGJAS⁴ TURFKRUYE, JOSEPH JOZALE ABRAHAM HANGJAS³ TURFKRUIJER, LEVY JOEL HANGJAS², JOEL JOSEPH HANGJAS¹*) was born 15 Apr 1892 in Haarlem, and died 22 Oct 1942 in Auschwitz. She married COENRAAD SAMUEL BERKELO. He was born 18 Jun 1891 in Groningen, and died 22 Oct 1942 in Auschwitz.

Child of JANSJE WALLACH and COENRAAD BERKELO is:

- i. CORNELIS⁸ BERKELO, b. 14 Sep 1926, Groningen; d. 28 Feb 1943, Auschwitz.

68. IZAAK JOSEF⁷ HANGJAS (*IZAAK JOSEF⁶, MAARTJE MARCUS⁵, MARCUS MORDECHAI JOSEPH JOZALE HANGJAS⁴ TURFKRUYE, JOSEPH JOZALE ABRAHAM HANGJAS³ TURFKRUIJER, LEVY JOEL HANGJAS², JOEL JOSEPH HANGJAS¹*) was born Abt. 1879 in Haarlem. He married MARGARETHA LAMET, daughter of NICOLAAS LAMET and JOHANNA VEERKAMP. She was born Abt. 1884 in Den Haag.

Child of IZAAK HANGJAS and MARGARETHA LAMET is:

112. i. JOHANNES WILHELMUS⁸ HANGJAS, b. 05 Sep 1902, Den Haag; d. 04 Oct 1975, Amsterdam.

69. ESTHER⁷ DUVEEN (*JOEL JOSEPH⁶, JOSEPH⁵, ENOCH ELKAN JOSEPH⁴, JOSEPH MOSES HANGJAS³, MOSES JOEL HANGJAS² TURFKRUIJER, JOEL JOSEPH HANGJAS¹*) was born 07 Nov 1870 in Hull, and died 22 Nov 1949. She married (1) JULES JACQUES LOWENGARD 09 Mar 1891. She married (2) JAMES HENRY DUVEEN 21 Nov 1911, son of HENRI HANGJAS-DUVEEN and BETJE DUVEEN. He was born 1873 in Haarlem, and died Aft. 1956.

Children of ESTHER DUVEEN and JULES LOWENGARD are:

- i. ARMAND⁸ LOWENGARD, b. 1893.
- ii. DOROTHY LOWENGARD.

70. JOSEPH JOEL⁷ DUVEEN (*JOEL JOSEPH⁶, JOSEPH⁵, ENOCH ELKAN JOSEPH⁴, JOSEPH MOSES HANGJAS³, MOSES JOEL HANGJAS² TURFKRUIJER, JOEL JOSEPH HANGJAS¹*) was born 14 Oct 1869 in Hull, and died 1939. He married ELSIE SALAMON 31 Jul 1899. She was born 18 Aug 1881 in New York.

Child of JOSEPH DUVEEN and ELSIE SALAMON is:

- i. DOROTHY⁸ DUVEEN, b. 1903; m. WILLIAM FRANCIS CUTHBERT GARTHWAITE, 23 Jul 1931.

71. CHARLES JOEL⁷ DUVEEN (*JOEL JOSEPH⁶, JOSEPH⁵, ENOCH ELKAN JOSEPH⁴, JOSEPH MOSES HANGJAS³, MOSES JOEL HANGJAS² TURFKRUIJER, JOEL JOSEPH HANGJAS¹*) was born 02 Dec 1871 in Kingston Upon Hull, Yorkshire, England, and died 1940. He married ANN KOHLER.

Child of CHARLES DUVEEN and ANN KOHLER is:

- i. CHARLES⁸ DUVEEN, b. 1922; d. 1978.

72. LOUIS⁷ DUVEEN (*JOEL JOSEPH⁶, JOSEPH⁵, ENOCH ELKAN JOSEPH⁴, JOSEPH MOSES HANGJAS³, MOSES JOEL HANGJAS² TURFKRUIJER, JOEL JOSEPH HANGJAS¹*) was born 21 Feb 1874 in Hull, and died 04 Mar 1920. He married HELEN BEATRICE SALAMON. She was born 11 Jun 1881.

Children of LOUIS DUVEEN and HELEN SALAMON are:

113. i. LEONARD⁸ DUVEEN, d. 1986.
- ii. CLAUDE DUVEEN, m. EILEEN ?.
- iii. ARTHUR DUVEEN.
- iv. MARGARET DUVEEN, d. 1942; m. WILLIAM ?.

73. EDWARD JOEL⁷ DUVEEN (*JOEL JOSEPH⁶, JOSEPH⁵, ENOCH ELKAN JOSEPH⁴, JOSEPH MOSES HANGJAS³, MOSES JOEL HANGJAS² TURFKRUIJER, JOEL JOSEPH HANGJAS¹*) was born 20 Mar 1875 in Hull, and died 1946. He married VERA MARSDEN 1912.

Children of EDWARD DUVEEN and VERA MARSDEN are:

- i. RAYMOND⁸ DUVEEN, b. 1921.
- ii. ROSETTE DUVEEN.

74. BENJAMIN JOEL⁷ DUVEEN (*JOEL JOSEPH⁶, JOSEPH⁵, ENOCH ELKAN JOSEPH⁴, JOSEPH MOSES HANGJAS³, MOSES JOEL HANGJAS² TURFKRUIJER, JOEL JOSEPH HANGJAS¹*) was born 07 Apr 1876, and died 1959 in New York.

Children of BENJAMIN JOEL DUVEEN are:

- i. RHODA⁸ DUVEEN.
- ii. BEN DUVEEN, b. 1915.

75. FLORENCE⁷ DUVEEN (*JOEL JOSEPH⁶, JOSEPH⁵, ENOCH ELKAN JOSEPH⁴, JOSEPH MOSES HANGJAS³, MOSES JOEL HANGJAS² TURFKRUIJER, JOEL JOSEPH HANGJAS¹*) was born 1886, and died 1945. She married RENE GIMPEL.

Children of FLORENCE DUVEEN and RENE GIMPEL are:

- i. CHARLES⁸ GIMPEL.
- ii. PETER GIMPEL.

76. JOHN JOEL⁷ DUVEEN (*JOEL JOSEPH⁶, JOSEPH⁵, ENOCH ELKAN JOSEPH⁴, JOSEPH MOSES HANGJAS³, MOSES JOEL HANGJAS² TURFKRUIJER, JOEL JOSEPH HANGJAS¹*) was born 13 Jan 1873 in Hull, and died 15 Oct 1951. He married BLANCHE GRIMES BUTLER 22 Apr 1903. She was born in New York.

Child of JOHN DUVEEN and BLANCHE BUTLER is:

- i. JOHN⁸ DUVEEN, b. 1907.

77. ROOSJE⁷ DE JONG (*EVA⁶ DUVEEN, MOZES⁵, ENOCH ELKAN JOSEPH⁴, JOSEPH MOSES HANGJAS³, MOSES JOEL HANGJAS² TURFKRUIJER, JOEL JOSEPH HANGJAS¹*) was born 17 Jun 1868 in Apeldoorn, and died 23 Nov 1942 in Auschwitz. She married DAVID SALOMON DE JONG 26 May 1891, son of SALOMON DE JONG and KLARA POLAK. He died 26 Mar 1939 in Eelde Drenthe.

Children of ROOSJE DE JONG and DAVID DE JONG are:

- i. SALOMON DAVID⁸ DE JONG, b. 04 May 1892.
- ii. SIMON RUDOLF DE JONG, b. 19 Feb 1898.
- iii. SOPHIA DE JONG, b. 08 May 1902.
- iv. RUDOLF DAVID SALOMON DE JONG, b. 01 Aug 1905.

78. SAARTJE⁷ DE JONG (*EVA⁶ DUVEEN, MOZES⁵, ENOCH ELKAN JOSEPH⁴, JOSEPH MOSES HANGJAS³, MOSES JOEL HANGJAS² TURFKRUIJER, JOEL JOSEPH HANGJAS¹*) was born 08 Nov 1871 in Apeldoorn, and died 12 Jan 1945 in Bergen Belsen. She married MAURITS MOGENDORFF 17 Dec 1895 in Doetinchem, son of JESAJA MOGENDORFF and GEZINA KOOPMANS. He was born 22 Mar 1868 in Groenlo, and died 27 Aug 1941 in Arnhem.

Children of SAARTJE DE JONG and MAURITS MOGENDORFF are:

114. i. CHARLES⁸ MOGENDORFF, b. 21 Dec 1897, Doetinchem; d. 03 Mar 1945, Bergen Belsen.
115. ii. EVALINE SUSANNE MOGENDORFF, b. 02 May 1900, Stad Doetinchem; d. 10 Oct 1989, Amsterdam.

79. SARA-SAARTJE⁷ DUVEEN (*HEIMAN MOZES⁶, MOZES⁵, ENOCH ELKAN JOSEPH⁴, JOSEPH MOSES HANGJAS³, MOSES JOEL HANGJAS² TURFKRUIJER, JOEL JOSEPH HANGJAS¹*) was born 04 Oct 1878 in Groningen, and died 08 Oct 1942 in Auschwitz. She married ? LEK.

Child of SARA-SAARTJE DUVEEN and ? LEK is:

- i. WILLIAM⁸ LEK, b. 01 Mar 1901, Amsterdam; d. 06 Feb 1945, Dachau.

80. REINA-REINTJE⁷ DUVEEN (*HEIMAN MOZES⁶, MOZES⁵, ENOCH ELKAN JOSEPH⁴, JOSEPH MOSES HANGJAS³, MOSES JOEL HANGJAS² TURFKRUIJER, JOEL JOSEPH HANGJAS¹*) was born 02 Oct 1879 in Groningen, and died 19 Nov 1943 in Auschwitz. She married LOUIS VAN STRATEN. He was born 27 Jan 1881 in Deil, and died 19 Nov 1943 in Auschwitz.

Children of REINA-REINTJE DUVEEN and LOUIS VAN STRATEN are:

- i. HERMAN⁸ VAN STRATEN.
- ii. SELMA VAN STRATEN.
- iii. LEON VAN STRATEN.
- iv. MAURITS VAN STRATEN.
- v. LENA VAN STRATEN.

81. MARCUS⁷ DUVEEN (*HEIMAN MOZES⁶, MOZES⁵, ENOCH ELKAN JOSEPH⁴, JOSEPH MOSES HANGJAS³, MOSES JOEL HANGJAS² TURFKRUIJER, JOEL JOSEPH HANGJAS¹*) was born 25 Aug 1882 in Groningen, and died 1970 in Hilversum. He married JETTE DUVEEN, daughter of HENOKH DUVEEN and HANNA KAN. She was born 25 Oct 1890, and died 1954 in Even Yehuda, Israel.

Children of MARCUS DUVEEN and JETTE DUVEEN are:

- i. HENRY⁸ DUVEEN.
- ii. JULIUS DUVEEN.
- iii. ADOLF DUVEEN.

82. HERMAN⁷ DUVEEN (*HEIMAN MOZES⁶, MOZES⁵, ENOCH ELKAN JOSEPH⁴, JOSEPH MOSES HANGJAS³, MOSES JOEL HANGJAS² TURFKRUIJER, JOEL JOSEPH HANGJAS¹*) was born 25 Feb 1885 in Groningen, and died 22 May 1944 in Auschwitz. He married CLARA STEIN. She was born 13 Jul 1890 in Cescher, and died 22 May 1944 in Auschwitz.

Children of HERMAN DUVEEN and CLARA STEIN are:

- i. LEO⁸ DUVEEN, b. 16 Apr 1920, Amsterdam; d. 15 Feb 1943, Seibersdorf.
- ii. MARCUS DUVEEN, b. 08 Nov 1921, Amsterdam; d. 10 Feb 1943, Seibersdorf.

83. SOPHIA-FIE⁷ DUVEEN (*HEIMAN MOZES⁶, MOZES⁵, ENOCH ELKAN JOSEPH⁴, JOSEPH MOSES HANGJAS³, MOSES JOEL HANGJAS² TURFKRUIJER, JOEL JOSEPH HANGJAS¹*) was born 06 Sep 1887 in Groningen, and died 28 May 1943 in Sobihor. She married MOZES VAN AMERINGEN. He was born 08 Jul 1888 in Amsterdam, and died 28 May 1943 in Sobihor.

Children of SOPHIA-FIE DUVEEN and MOZES VAN AMERINGEN are:

- i. LENY⁸ VAN AMERINGEN.
- ii. JACOBUS VAN AMERINGEN.

84. JETTE⁷ DUVEEN (*HENOKH MOZES⁶, MOZES⁵, ENOCH ELKAN JOSEPH⁴, JOSEPH MOSES HANGJAS³, MOSES JOEL HANGJAS² TURFKRUIJER, JOEL JOSEPH HANGJAS¹*) was born 25 Oct 1890, and died 1954 in Even Yehuda, Israel. She married MARCUS DUVEEN, son of HEIMAN DUVEEN and LEENTJE DE LEEUW. He was born 25 Aug 1882 in Groningen, and died 1970 in Hilversum.

Children are listed above under (81) Marcus Duveen.

85. SOPHIA⁷ DUVEEN (*HENOKH MOZES⁶, MOZES⁵, ENOCH ELKAN JOSEPH⁴, JOSEPH MOSES HANGJAS³, MOSES JOEL HANGJAS² TURFKRUIJER, JOEL JOSEPH HANGJAS¹*) She married ? VAN DIJK.

Children of SOPHIA DUVEEN and ? VAN DIJK are:

116. i. DIEN⁸ VAN DIJK, b. Hilversum.
- ii. SJEF VAN DIJK.
- iii. ANNEKE-ANNE VAN DIJK.
117. iv. HERMAN VAN DIJK.

86. HARTOG⁷ DUVEEN (*HENOCH MOZES⁶, MOZES⁵, ENOCH ELKAN JOSEPH⁴, JOSEPH MOSES HANGJAS³, MOSES JOEL HANGJAS² TURFKRUIJER, JOEL JOSEPH HANGJAS¹*) was born 1885, and died 1944 in Norwich. He married JOHANNA DUIITS.

Child of HARTOG DUVEEN and JOHANNA DUIITS is:

- i. ROBERT WILLIAM HAROLD⁸ DUVEEN, m. VIRGINIA HEHENKAMP.

87. ABRAHAM-ABIE⁷ MOZES (*HENOCH MOZES⁶ DUVEEN, MOZES⁵, ENOCH ELKAN JOSEPH⁴, JOSEPH MOSES HANGJAS³, MOSES JOEL HANGJAS² TURFKRUIJER, JOEL JOSEPH HANGJAS¹*) was born 22 Mar 1893 in Amsterdam, and died 07 Aug 1942 in Auschwitz. He married HETTY CASUTTO.

Child of ABRAHAM-ABIE MOZES and HETTY CASUTTO is:

- i. HANS-HENRY⁸ DUVEEN.

88. SIMSON⁷ DUVEEN (*WOLF⁶, MOZES⁵, ENOCH ELKAN JOSEPH⁴, JOSEPH MOSES HANGJAS³, MOSES JOEL HANGJAS² TURFKRUIJER, JOEL JOSEPH HANGJAS¹*) was born 30 Jun 1883 in Winschoten, and died 12 Feb 1943 in Auschwitz. She married RACHELTJE PAIS 1920. He was born 15 Mar 1892 in Harlingen, and died 12 Feb 1943 in Auschwitz.

Children of SIMSON DUVEEN and RACHELTJE PAIS are:

- i. REBEKKA⁸ DUVEEN, b. 21 Feb 1921, Winschoten; d. 12 Feb 1943, Auschwitz.
- ii. AARON DUVEEN, b. 05 Mar 1922, Winschoten; d. 12 Feb 1943, Auschwitz.

Generation No. 8

89. IAN LISTER⁸ HANDRICKS (*EDWIN (EDDIE) LISTER⁷, NORMAN (NORRIE) FREDERICK JAMES⁶, JOZEF LEVI⁵, LEVIE JOSEPH JOZALE⁴ HANGJAS, JOSEPH JOZALE ABRAHAM HANGJAS³ TURFKRUIJER, LEVY JOEL HANGJAS², JOEL JOSEPH HANGJAS¹*) was born 06 Jul 1955 in At Home, 9 Farringdon St, Glen Innes, Auckland. He married JOCELYN RUTH BROWN 11 Feb 1978 in Holy Trinity Anglican Church, Dargaville, daughter of OWEN BROWN and ROMA SIMONS. She was born 16 Dec 1954 in Te Kopuru.

Children of IAN HANDRICKS and JOCELYN BROWN are:

- i. DANIEL LOGAN⁹ HANDRICKS, b. 20 May 1981, National Women's Hospital, Auckland; d. 08 May 2017, 40 Grant Ave, Hope Island, Gold Coast, Queensland, Australia.
- ii. HELEN RUBY HANDRICKS, b. 31 Oct 1983, John Radcliffe Hospital, Oxford, England; m. RICHARD GLEW, 03 Jan 2020, Australia.
- iii. ÉLOÏSE ADÈLE HANDRICKS, b. 11 Oct 1985, John Radcliffe Hospital, Oxford, England; m. ANTON GILBERT, 03 Oct 2020, Brisbane, Australia.

90. LYNETTE MARGARET⁸ HANDRICKS (*EDWIN (EDDIE) LISTER⁷, NORMAN (NORRIE) FREDERICK JAMES⁶, JOZEF LEVI⁵, LEVIE JOSEPH JOZALE⁴ HANGJAS, JOSEPH JOZALE ABRAHAM HANGJAS³ TURFKRUIJER, LEVY JOEL HANGJAS², JOEL JOSEPH HANGJAS¹*) was born 02 Jul 1957 in At Home, 9 Farringdon St, Glen Innes, Auckland. She married SIANG HUAT OOI 25 Mar 1978 in Auckland, son of HOI OOI and SAW PHAN. He was born 30 Nov 1952 in Malaysia.

Children of LYNETTE HANDRICKS and SIANG OOI are:

- i. LISA MARGARET⁹ OOI, b. 20 Oct 1981.
118. ii. FIONA MAY OOI, b. 22 Mar 1984, Auckland.
- iii. ROBYN JANE OOI, b. 31 Dec 1987.

91. GLENN PETER⁸ HANDRICKS (*EDWIN (EDDIE) LISTER⁷, NORMAN (NORRIE) FREDERICK JAMES⁶, JOZEF LEVI⁵, LEVIE JOSEPH JOZALE⁴ HANGJAS, JOSEPH JOZALE ABRAHAM HANGJAS³ TURFKRUIJER, LEVY JOEL HANGJAS², JOEL JOSEPH HANGJAS¹*) was born 03 Mar 1966 in Middlemore Hospital, Auckland. He married (1) JUNE ELIZABETH DAVISON 12 Sep 1987 in Auckland, daughter of ROY BRINK and MARJORIE PAPE. She was born 06 Mar 1966 in Australia. He married (2) FAY LUCINDA WILKINSON 13 Jul 2019 in Sandy Creek, Queensland, daughter of ROBERT WILKINSON and LEILA SANDERS. She was born 04 Mar 1965 in Horsham, Victoria.

Children of GLENN HANDRICKS and JUNE DAVISON are:

- i. KIMBERLEY MARIE⁹ HANDRICKS, b. 15 Jul 1995, Auckland.
- ii. KELLIE JUNE HANDRICKS, b. 15 Mar 1998, Auckland.

92. LINDA MAY⁸ HANDRICKS (*ROBERT HARRY⁷, NORMAN (NORRIE) FREDERICK JAMES⁶, JOZEF LEVI⁵, LEVIE JOSEPH JOZALE⁴ HANGJAS, JOSEPH JOZALE ABRAHAM HANGJAS³ TURFKRUIJER, LEVY JOEL HANGJAS², JOEL JOSEPH HANGJAS¹*) was born 11 Sep 1962. She married RAYMOND JOHN MCLEAN 16 Sep 1987. He was born 12 Sep 1962.

Children of LINDA HANDRICKS and RAYMOND MCLEAN are:

- i. CHARLOTTE (CHARLIE) MAY⁹ MCLEAN, b. 15 Mar 1987.
- ii. MAX CHRISTIAN MCLEAN, b. 08 Sep 1988.

93. PAUL⁸ HANDRICKS (*NORMAN LESLIE⁷, NORMAN (NORRIE) FREDERICK JAMES⁶, JOZEF LEVI⁵, LEVIE JOSEPH JOZALE⁴ HANGJAS, JOSEPH JOZALE ABRAHAM HANGJAS³ TURFKRUIJER, LEVY JOEL HANGJAS², JOEL JOSEPH HANGJAS¹*) was born 23 Mar 1944 in Masterton. He married VICKI ASHTON CHATFIELD 11 Jan 1966 in Gisborne, daughter of KEITH CHATFIELD and PIKI MORRELL. She was born 12 Jun 1948 in Opotiki.

Children of PAUL HANDRICKS and VICKI CHATFIELD are:

119. i. PAUL KEITH NORMAN⁹ HANDRICKS, b. 18 Aug 1967, Opotiki.
120. ii. LISA-JANE HANDRICKS, b. 26 Jul 1969, Opotiki.
121. iii. LEIGH-ANNE HANDRICKS, b. 20 Jul 1966, Opotiki.
121. iv. JOANNE ASHTON HANDRICKS, b. 27 Jun 1970, Gisborne.

94. YVONNE IRENE⁸ HANDRICKS (*DOUGLAS HUBERT NELSON⁷, NORMAN (NORRIE) FREDERICK JAMES⁶, JOZEF LEVI⁵, LEVIE JOSEPH JOZALE⁴ HANGJAS, JOSEPH JOZALE ABRAHAM HANGJAS³ TURFKRUIJER, LEVY JOEL HANGJAS², JOEL JOSEPH HANGJAS¹*) was born 29 Dec 1940 in Auckland. She married (1) ROBERT NORMAN FOGAL Abt. 1957 in Akron New York, son of GEORGE FOGAL and FLORENCE STIBBS. He was born 19 Oct 1931 in on the family farm, Akron, New York. She married (2) LEON FOSTER ROWIN 26 Feb 1966 in Los Angeles, son of ROLLIE ROWIN and ETHEL VAN DUZEE. He was born 19 Aug 1938.

Children of YVONNE HANDRICKS and ROBERT FOGAL are:

122. i. WADE EDWARD⁹ FOGAL, b. 22 Sep 1957, California.
123. ii. VICTORIA LYNNE FOGAL, b. 04 Oct 1958, California.
123. iii. RAYMIE PAUL FOGAL, b. 04 Apr 1961, Hawthorne, Ca.

Child of YVONNE HANDRICKS and LEON ROWIN is:

124. iv. STEVEN LEE⁹ ROWIN, b. 09 Oct 1966, California.

95. JOSEPHINE⁸ JOSEPH (*MORRIS CEDRIC CLARE⁷, SARAH ELIZABET (LILY)⁶ HANDRICKS, JOZEF LEVI⁵, LEVIE JOSEPH JOZALE⁴ HANGJAS, JOSEPH JOZALE ABRAHAM HANGJAS³ TURFKRUIJER, LEVY JOEL HANGJAS², JOEL JOSEPH HANGJAS¹*) was born 01 Oct 1920. She married LESLIE JAMES BUTCHER. He was born 22 Feb 1918.

Children of JOSEPHINE JOSEPH and LESLIE BUTCHER are:

125. i. WARWICK HUGH JOSEPH⁹ BUTCHER, b. 16 Feb 1947.
126. ii. CHRISTINE LESLEY BUTCHER, b. 23 Aug 1948.
127. iii. FREDERICK JOHN MARSHALL BUTCHER, b. 26 May 1958.

96. BERESFORD (BERRY) CLARE⁸ JOSEPH (*MORRIS CEDRIC CLARE⁷, SARAH ELIZABET (LILY)⁶ HANDRICKS, JOZEF LEVI⁵, LEVIE JOSEPH JOZALE⁴ HANGJAS, JOSEPH JOZALE ABRAHAM HANGJAS³ TURFKRUIJER, LEVY JOEL HANGJAS², JOEL JOSEPH HANGJAS¹*) was born 14 Apr 1922, and died 13 Mar 2007. He married BERYL JUNE BAINES, daughter of ERNEST BAINES and BERTHA ROWELL. She was born 09 Jun 1927 in Footscray.

Children of BERESFORD JOSEPH and BERYL BAINES are:

128. i. ROGER LEWIS⁹ JOSEPH, b. Abt. 1951.
129. ii. CHARMAINE ANNE JOSEPH, b. 24 Oct 1952.
130. iii. ROSEMARY JANE JOSEPH, b. 12 Mar 1956.

97. DAVID LEOPOLD⁸ JOSEPH (*MORRIS CEDRIC CLARE*⁷, *SARAH ELIZABET (LILY)*⁶ *HANDRICKS*, *JOZEF LEVI*⁵, *LEVIE JOSEPH JOZALE*⁴ *HANGJAS*, *JOSEPH JOZALE ABRAHAM HANGJAS*³ *TURFKRUIJER*, *LEVY JOEL HANGJAS*², *JOEL JOSEPH HANGJAS*¹) was born 13 Feb 1927. He married GWENDOLINE ELSIE BROWN. She was born 22 Apr 1929.

Children of DAVID JOSEPH and GWENDOLINE BROWN are:

- i. DIANNE⁹ JOSEPH, d. 06 Apr 2005.
- ii. RONALD JOSEPH.
- iii. CHERYL JOSEPH, m. VANCE MOORE.
- iv. JANICE JOSEPH.

98. NATHAN COLEMAN⁸ JOSEPH (*MORRIS CEDRIC CLARE*⁷, *SARAH ELIZABET (LILY)*⁶ *HANDRICKS*, *JOZEF LEVI*⁵, *LEVIE JOSEPH JOZALE*⁴ *HANGJAS*, *JOSEPH JOZALE ABRAHAM HANGJAS*³ *TURFKRUIJER*, *LEVY JOEL HANGJAS*², *JOEL JOSEPH HANGJAS*¹) was born 12 Sep 1930. He married (1) BETTY (VICKY) RIDER. She was born 27 Nov 1936. He married (2) MARMIE MARTINEZ. She was born 14 Aug 1960.

Children of NATHAN JOSEPH and BETTY RIDER are:

- i. STEVEN⁹ JOSEPH.
- ii. JUDY JOSEPH.
- iii. DARREN JOSEPH.

Child of NATHAN JOSEPH and MARMIE MARTINEZ is:

- iv. JUSTIN CEDRIC⁹ JOSEPH, b. 01 Jul 1997.

99. ELIZABETH ISOBEL⁸ JOSEPH (*MORRIS CEDRIC CLARE*⁷, *SARAH ELIZABET (LILY)*⁶ *HANDRICKS*, *JOZEF LEVI*⁵, *LEVIE JOSEPH JOZALE*⁴ *HANGJAS*, *JOSEPH JOZALE ABRAHAM HANGJAS*³ *TURFKRUIJER*, *LEVY JOEL HANGJAS*², *JOEL JOSEPH HANGJAS*¹) was born 22 Jun 1932. She married RONALD THOMAS MITCHELL. He was born 16 Jun 1916, and died 1980.

Children of ELIZABETH JOSEPH and RONALD MITCHELL are:

- i. LINDA ELIZABETH⁹ MITCHELL, b. 11 Jul 1958; m. CARMELO VITO LA SPADA; b. 12 May 1934, Sardinia.
131. ii. JOHN LESLY MITCHELL, b. 29 Sep 1959.
132. iii. MICHAEL RONALD MITCHELL, b. 26 Jan 1962.
- iv. JENNIFER MARGARET MITCHELL, b. 04 Jul 1968; m. (JULIAN) WENG CHEE CHAN; b. 23 May 1957.

100. VALERIE VIOLET⁸ JOSEPH (*MORRIS CEDRIC CLARE*⁷, *SARAH ELIZABET (LILY)*⁶ *HANDRICKS*, *JOZEF LEVI*⁵, *LEVIE JOSEPH JOZALE*⁴ *HANGJAS*, *JOSEPH JOZALE ABRAHAM HANGJAS*³ *TURFKRUIJER*, *LEVY JOEL HANGJAS*², *JOEL JOSEPH HANGJAS*¹) was born 15 Jan 1934. She married STANLEY RYAN. He was born 04 Oct 1930.

Children of VALERIE JOSEPH and STANLEY RYAN are:

133. i. LEONARD WAYNE⁹ RYAN, b. 31 Jan 1956.
134. ii. SUSAN LINDA RYAN, b. 12 Feb 1957.
135. iii. NANCY JANE RYAN, b. 01 Mar 1959.
136. iv. DONNA KAY RYAN, b. 17 Nov 1962.
137. v. JEANINE MAY RYAN, b. 17 Nov 1962.

101. RONALD D'ESTERRE⁸ MINCHIN (*IRIS VERA ISABELLE*⁷ *TOMPSON*, *AMELIA (MILLIE) JANE*⁶ *HANDRICKS*, *JOZEF LEVI*⁵, *LEVIE JOSEPH JOZALE*⁴ *HANGJAS*, *JOSEPH JOZALE ABRAHAM HANGJAS*³ *TURFKRUIJER*, *LEVY JOEL HANGJAS*², *JOEL JOSEPH HANGJAS*¹) was born 15 Jan 1923 in Perth, Western Australia, Australia. He married (1) ELIZABETH BAGOT CURTISS 15 Nov 1944 in London England. She was born Abt. 1923 in Western Australia, Australia. He married (2) SHIRLEY DOROTHY WALKER 18 Jun 1971 in Victoria, Australia. She was born 1923.

Children of RONALD MINCHIN and ELIZABETH CURTISS are:

- i. RONALD IAN D'ESTERRE⁹ MINCHIN, b. 12 Dec 1945.
- ii. ANGELA MINCHIN, b. 05 Sep 1949; m. JOHN ROZIER.

102. HUBERT BRIAN⁸ MINCHIN (*IRIS VERA ISABELLE⁷ TOMPSON, AMELIA (MILLIE) JANE⁶ HANDRICKS, JOZEF LEVI⁵, LEVIE JOSEPH JOZALE⁴ HANGJAS, JOSEPH JOZALE ABRAHAM HANGJAS³ TURFKRUIJER, LEVY JOEL HANGJAS², JOEL JOSEPH HANGJAS¹*) was born 21 Sep 1924 in Perth, Western Australia, Australia. He married JILL LEONHARDT 29 Jan 1954.

Child of HUBERT MINCHIN and JILL LEONHARDT is:

- i. FIONA⁹ MINCHIN, b. 02 Mar 1964.

103. WILLIAM PENN⁸ MINCHIN (*IRIS VERA ISABELLE⁷ TOMPSON, AMELIA (MILLIE) JANE⁶ HANDRICKS, JOZEF LEVI⁵, LEVIE JOSEPH JOZALE⁴ HANGJAS, JOSEPH JOZALE ABRAHAM HANGJAS³ TURFKRUIJER, LEVY JOEL HANGJAS², JOEL JOSEPH HANGJAS¹*) was born 06 Apr 1927 in Perth, Western Australia, Australia. He married JOY MARJORY FRASER 21 Jun 1952.

Children of WILLIAM MINCHIN and JOY FRASER are:

- i. MICHAEL⁹ MINCHIN, b. 05 Aug 1954.
- ii. PENELOPE MINCHIN, b. 05 Jul 1953.
- iii. PHILIPPA MINCHIN, b. 02 Jul 1956.
- iv. KATE ELIZABETH MINCHIN, b. 31 Dec 1961.

104. ROSS⁸ MINCHIN (*IRIS VERA ISABELLE⁷ TOMPSON, AMELIA (MILLIE) JANE⁶ HANDRICKS, JOZEF LEVI⁵, LEVIE JOSEPH JOZALE⁴ HANGJAS, JOSEPH JOZALE ABRAHAM HANGJAS³ TURFKRUIJER, LEVY JOEL HANGJAS², JOEL JOSEPH HANGJAS¹*) was born 29 Dec 1936 in Perth. He married PAMELA ANN HADDAD 03 Mar 1962.

Children of ROSS MINCHIN and PAMELA HADDAD are:

- i. PAUL D'ESTERRE⁹ MINCHIN, b. 23 Feb 1965.
- ii. BRADLEY ROSS MINCHIN, b. 22 Sep 1966.

105. IAN HUGH⁸ MINCHIN (*IRIS VERA ISABELLE⁷ TOMPSON, AMELIA (MILLIE) JANE⁶ HANDRICKS, JOZEF LEVI⁵, LEVIE JOSEPH JOZALE⁴ HANGJAS, JOSEPH JOZALE ABRAHAM HANGJAS³ TURFKRUIJER, LEVY JOEL HANGJAS², JOEL JOSEPH HANGJAS¹*) was born 28 Nov 1938 in Perth. He married CAROL ANNE JONES 28 Oct 1961.

Children of IAN MINCHIN and CAROL JONES are:

- i. LISA JEANETTE⁹ MINCHIN, b. 24 Jun 1964.
- ii. KERRI SUSAN MINCHIN, b. 04 Dec 1966.
- iii. SUSAN JANE MINCHIN, b. 21 Aug 1968.
- iv. NICOLE LOUISE MINCHIN, b. 26 Nov 1970.

106. ISRAEL LEENDERT⁸ HANGJAS (*JESAIA⁷, SAARTJE⁶, MOZES LEVI⁵, LEVIE JOSEPH JOZALE⁴, JOSEPH JOZALE ABRAHAM HANGJAS³ TURFKRUIJER, LEVY JOEL HANGJAS², JOEL JOSEPH HANGJAS¹*) was born 03 Jun 1897 in Amsterdam, and died 16 Apr 1943 in Sobibor. He married BETJE BOEKEN 19 Nov 1919 in Amsterdam, daughter of MARCUS BOEKEN and HEINTJE GOEDEL. She was born 22 Jan 1900 in Amsterdam, and died 16 Apr 1943 in Sobibor.

Children of ISRAEL HANGJAS and BETJE BOEKEN are:

- i. JESAIA⁹ HANGJAS, b. 11 May 1920, Amsterdam; d. 30 Sep 1942, Auschwitz; m. ESTHER LEVIT; b. 31 May 1920, Amsterdam; d. 30 Sep 1942, Auschwitz.
138. ii. HENDRIKA HANGJAS, b. 07 Dec 1921, Amsterdam; d. 29 Jul 1942, Auschwitz.
- iii. SAMUEL HANGJAS, b. 16 Mar 1923, Amsterdam; d. 07 May 1942, Amsterdam.
- iv. BRANCA HANGJAS, b. 01 Dec 1924, Amsterdam; d. 30 Sep 1942, Auschwitz.
- v. ABRAHAM HANGJAS, b. 07 Sep 1930, Amsterdam; d. 16 Apr 1943, Sobibor.
- vi. MARIANNA HANGJAS, b. 04 Sep 1933, Amsterdam; d. 16 Apr 1943, Sobibor.
- vii. MAX HANGJAS, b. 22 Oct 1936, Amsterdam; d. 16 Apr 1943, Sobibor.

107. ABRAHAM⁸ HANGJAS (*JESAIA⁷, SAARTJE⁶, MOZES LEVI⁵, LEVIE JOSEPH JOZALE⁴, JOSEPH JOZALE ABRAHAM HANGJAS³ TURFKRUIJER, LEVY JOEL HANGJAS², JOEL JOSEPH HANGJAS¹*) was born 27 Sep 1898 in Amsterdam, and died 31 Mar 1944 in Auschwitz. He married JETJE PILLER 24 Jul 1918 in Amsterdam, daughter of JONAS PILLER and BETJE KETELLAPPER. She was born 20 Nov 1898 in Amsterdam, and died 19 Oct 1942 in Auschwitz.

Child of ABRAHAM HANGJAS and JETJE PILLER is:

139. i. KLARA⁹ HANGJAS, b. 10 May 1923, Amsterdam; d. 19 Oct 1942, Auschwitz.

108. MOSES⁸ HANGJAS (*JESAIA*⁷, *SAARTJE*⁶, *MOZES LEVI*⁵, *LEVIE JOSEPH JOZALE*⁴, *JOSEPH JOZALE ABRAHAM HANGJAS*³ *TURFKRUIJER*, *LEVY JOEL HANGJAS*², *JOEL JOSEPH HANGJAS*¹) was born 13 Jun 1901 in Amsterdam, and died 13 Mar 1943 in Sobibor. He married SARA BOEKEN 01 Mar 1922 in Amsterdam. She was born 03 Aug 1902 in Amsterdam, and died 24 Sep 1942 in Auschwitz.

Children of MOSES HANGJAS and SARA BOEKEN are:

- i. JESAIA⁹ HANGJAS, b. 30 Sep 1922, Amsterdam; d. 09 Apr 1943, Sobibor.
- ii. MAX HANGJAS, b. 21 Jan 1927, Amsterdam; d. 31 Jan 1943, Monowitz.
- iii. CLARA HANGJAS, b. 13 Feb 1928, Amsterdam; d. 24 Sep 1942, Monowitz.
- iv. HENDRIKA HANGJAS, b. 14 Nov 1929, Amsterdam; d. 24 Sep 1942, Monowitz.
- v. LEENDERT HANGJAS, b. 03 Jan 1931, Amsterdam; d. 24 Sep 1942, Auschwitz.
- vi. ARON HANGJAS, b. 08 Apr 1932, Amsterdam; d. 24 Sep 1942, Monowitz.
- vii. ABRAHAM HANGJAS, b. 25 Oct 1934, Amsterdam; d. 24 Sep 1942, Monowitz.
- viii. BRANCA HANGJAS, b. 24 Feb 1936, Amsterdam; d. 24 Sep 1942, Monowitz.
- ix. HARRY HANGJAS, b. 04 May 1940, Amsterdam; d. 24 Sep 1942, Monowitz.
- x. MARIANNE HANGJAS, b. 17 Sep 1941, Amsterdam; d. 24 Sep 1942, Auschwitz.

109. HARTOG⁸ HANGJAS (*JESAIA*⁷, *SAARTJE*⁶, *MOZES LEVI*⁵, *LEVIE JOSEPH JOZALE*⁴, *JOSEPH JOZALE ABRAHAM HANGJAS*³ *TURFKRUIJER*, *LEVY JOEL HANGJAS*², *JOEL JOSEPH HANGJAS*¹) was born 03 Dec 1904 in Amsterdam, and died 31 Jan 1943 in Monowitz. He married CLARA GROEN 25 Oct 1933 in Amsterdam. She was born 19 Jan 1907 in Amsterdam, and died 12 Oct 1942 in Auschwitz.

Children of HARTOG HANGJAS and CLARA GROEN are:

- i. JACQUES⁹ HANGJAS, b. 08 Aug 1935, Amsterdam; d. 12 Oct 1942, Auschwitz.
- ii. HANS HANGJAS, b. 21 Jun 1939, Amsterdam; d. 12 Oct 1942, Monowitz.

110. ANNA⁸ HANGJAS (*JESAIA*⁷, *SAARTJE*⁶, *MOZES LEVI*⁵, *LEVIE JOSEPH JOZALE*⁴, *JOSEPH JOZALE ABRAHAM HANGJAS*³ *TURFKRUIJER*, *LEVY JOEL HANGJAS*², *JOEL JOSEPH HANGJAS*¹) was born 09 Apr 1907 in Amsterdam, and died 23 Apr 1943 in Sobibor. She married LEVIE WATERMAN 28 Nov 1928 in Amsterdam, son of HARTOG WATERMAN and BERTHA PLAS. He was born 28 Dec 1907 in Amsterdam, and died 30 Nov 1943 in Dorohucza.

Children of ANNA HANGJAS and LEVIE WATERMAN are:

- i. HARTOG⁹ WATERMAN, b. 02 May 1929, Amsterdam; d. 23 Apr 1943, Sobibor.
- ii. JESAIA WATERMAN, b. 20 May 1935, Amsterdam; d. 23 Apr 1943, Sobibor.
- iii. BERTHA WATERMAN, b. 06 May 1938, Amsterdam; d. 23 Apr 1943, Sobibor.
- iv. CLARA WATERMAN, b. 25 Nov 1939, Amsterdam; d. 23 Apr 1943, Sobibor.
- v. SARA WATERMAN, b. 02 May 1941, Amsterdam; d. 23 Apr 1943, Sobibor.

111. DAVID⁸ VIEIJRA (*JUDIK*⁷ *HANGJAS*, *MARCUS JOSEPH*⁶, *JOSEPH MARCUS*⁵, *MARCUS MORDECHAI JOSEPH JOZALE HANGJAS*⁴ *TURFKRUYE*, *JOSEPH JOZALE ABRAHAM HANGJAS*³ *TURFKRUIJER*, *LEVY JOEL HANGJAS*², *JOEL JOSEPH HANGJAS*¹) was born 23 Sep 1909 in Antwerpen, and died 11 Sep 1942 in Auschwitz. He married JEANETTE (NETTIE) PLAS. She was born 22 Aug 1905 in Amsterdam, and died 11 Sep 1942 in Auschwitz.

Children of DAVID VIEIJRA and JEANETTE PLAS are:

- i. ESTHER⁹ VIEIJRA, b. 12 Oct 1936, Antwerpen; d. 11 Sep 1942, Auschwitz.
- ii. MAURICE VIEIJRA, b. 20 May 1938, Antwerpen; d. 11 Sep 1942, Auschwitz.

112. JOHANNES WILHELMUS⁸ HANGJAS (*Izaak Josef*⁷, *Izaak Josef*⁶, *Maartje Marcus*⁵, *Marcus Mordechai Joseph Jozale Hangjas*⁴ *Turfkruye*, *Joseph Jozale Abraham Hangjas*³ *Turfkruijer*, *Levy Joel Hangjas*², *Joel Joseph Hangjas*¹) was born 05 Sep 1902 in Den Haag, and died 04 Oct 1975 in Amsterdam. He married MARIA SIMONS 02 Nov 1927 in Amsterdam, daughter of ANTONIUS SIMONS and JOHANNA WIERINK. She was born 25 Jul 1907 in Amsterdam, and died 11 Jul 1976 in Amsterdam.

Child of JOHANNES HANGJAS and MARIA SIMONS is:

140. i. GREETJE⁹ HANGJAS.

113. LEONARD⁸ DUVEEN (*LOUIS*⁷, *JOEL JOSEPH*⁶, *JOSEPH*⁵, *ENOCH ELKAN JOSEPH*⁴, *JOSEPH MOSES HANGJAS*³, *MOSES JOEL HANGJAS*² *TURFKRUIJER*, *JOEL JOSEPH HANGJAS*¹) died 1986. He married JOY ?.

Child of LEONARD DUVEEN and JOY ? is:

- i. CLIVE⁹ DUVEEN, b. 1928.

114. CHARLES⁸ MOGENDORFF (*SAARTJE*⁷ *DE JONG*, *EVA*⁶ *DUVEEN*, *MOZES*⁵, *ENOCH ELKAN JOSEPH*⁴, *JOSEPH MOSES HANGJAS*³, *MOSES JOEL HANGJAS*² *TURFKRUIJER*, *JOEL JOSEPH HANGJAS*¹) was born 21 Dec 1897 in Doetinchem, and died 03 Mar 1945 in Bergen Belsen. He married REINTJE VAN DER HORST. She was born 05 Feb 1898 in Steenwijk, and died 11 Jun 1943 in Sobihor.

Children of CHARLES MOGENDORFF and REINTJE HORST are:

- i. BETTY SARA⁹ MOGENDORFF, b. 12 Dec 1929.
- ii. MAURITS MOGENDORFF, b. 09 Mar 1932.

115. EVALINE SUSANNE⁸ MOGENDORFF (*SAARTJE*⁷ *DE JONG*, *EVA*⁶ *DUVEEN*, *MOZES*⁵, *ENOCH ELKAN JOSEPH*⁴, *JOSEPH MOSES HANGJAS*³, *MOSES JOEL HANGJAS*² *TURFKRUIJER*, *JOEL JOSEPH HANGJAS*¹) was born 02 May 1900 in Stad Doetinchem, and died 10 Oct 1989 in Amsterdam. She married (1) CHARLES PREEGERS. She married (2) HARTOG VAN ESSO 02 Jun 1921 in Doetinchem. He was born 01 May 1892 in Meppel, and died 19 Apr 1945 in Schipkau.

Children of EVALINE MOGENDORFF and HARTOG VAN ESSO are:

- i. ANNIE-ANNY⁹ VAN ESSO.
- ii. SERA VAN ESSO.

116. DIEN⁸ VAN DIJK (*SOPHIA*⁷ *DUVEEN*, *HENOCH MOZES*⁶, *MOZES*⁵, *ENOCH ELKAN JOSEPH*⁴, *JOSEPH MOSES HANGJAS*³, *MOSES JOEL HANGJAS*² *TURFKRUIJER*, *JOEL JOSEPH HANGJAS*¹) was born in Hilversum. She married ISADORE LOPES CARDOSO.

Child of DIEN VAN DIJK and ISADORE CARDOSO is:

- i. ? LOPES⁹ CARDOSO.

117. HERMAN⁸ VAN DIJK (*SOPHIA*⁷ *DUVEEN*, *HENOCH MOZES*⁶, *MOZES*⁵, *ENOCH ELKAN JOSEPH*⁴, *JOSEPH MOSES HANGJAS*³, *MOSES JOEL HANGJAS*² *TURFKRUIJER*, *JOEL JOSEPH HANGJAS*¹) He married LENY COHEN.

Child of HERMAN VAN DIJK and LENY COHEN is:

- i. DINA⁹ VAN DIJK.

Generation No. 9

118. FIONA MAY⁹ OOI (*LYNETTE MARGARET*⁸ *HANDRICKS*, *EDWIN (EDDIE) LISTER*⁷, *NORMAN (NORRIE) FREDERICK JAMES*⁶, *JOZEF LEVI*⁵, *LEVIE JOSEPH JOZALE*⁴ *HANGJAS*, *JOSEPH JOZALE ABRAHAM HANGJAS*³ *TURFKRUIJER*, *LEVY JOEL HANGJAS*², *JOEL JOSEPH HANGJAS*¹) was born 22 Mar 1984 in Auckland. She married ANTONIO MASTELLONE 19 Oct 2014 in Massa Lubrense, Italy.

Child of FIONA OOI and ANTONIO MASTELLONE is:

- i. SILVANA¹⁰ MASTELLONE, b. 05 Jan 2016, Italy.

119. PAUL KEITH NORMAN⁹ HANDRICKS (*PAUL*⁸, *NORMAN LESLIE*⁷, *NORMAN (NORRIE) FREDERICK JAMES*⁶, *JOZEF LEVI*⁵, *LEVIE JOSEPH JOZALE*⁴ *HANGJAS*, *JOSEPH JOZALE ABRAHAM HANGJAS*³ *TURFKRUIJER*, *LEVY JOEL HANGJAS*², *JOEL JOSEPH HANGJAS*¹) was born 18 Aug 1967 in Opotiki. He married (1) KAREN GALLY. He married (2) LINDA REECE, daughter of DAVID REECE and NORMA GOODSPEED. He married (3) OLIVIA BAYLISS.

Children of PAUL HANDRICKS and KAREN GALLY are:

- i. BENJAMIN¹⁰ HANDRICKS, b. 01 Jan 1992.
- ii. KELVIN HANDRICKS, b. 02 Apr 1993.

Child of PAUL HANDRICKS and LINDA REECE is:

- iii. DEVON NORMAN¹⁰ REECE, b. 17 Sep 1999.

Children of PAUL HANDRICKS and OLIVIA BAYLISS are:

- iv. LEVI JOSEF¹⁰ BAYLISS-HANDRICKS, b. 08 Jan 2020, Wellington.
- v. HAZEL BAYLISS-HANDRICKS, b. Aug 2021, Raumati.

120. LISA-JANE⁹ HANDRICKS (*PAUL⁸, NORMAN LESLIE⁷, NORMAN (NORRIE) FREDERICK JAMES⁶, JOZEF LEVI⁵, LEVIE JOSEPH JOZALE⁴ HANGJAS, JOSEPH JOZALE ABRAHAM HANGJAS³ TURFKRUIJER, LEVY JOEL HANGJAS², JOEL JOSEPH HANGJAS¹*) was born 26 Jul 1969 in Opotiki. She met CARL PHILPOTT. He was born 13 Jul 1972 in Auckland.

Children of LISA-JANE HANDRICKS and CARL PHILPOTT are:

- i. FLETCHER NORMAN¹⁰ PHILPOTT, b. 14 Feb 2004, Whakatane.
- ii. SPENCER HENRI PHILPOTT, b. 23 Sep 2005, Whakatane.

121. JOANNE ASHTON⁹ HANDRICKS (*PAUL⁸, NORMAN LESLIE⁷, NORMAN (NORRIE) FREDERICK JAMES⁶, JOZEF LEVI⁵, LEVIE JOSEPH JOZALE⁴ HANGJAS, JOSEPH JOZALE ABRAHAM HANGJAS³ TURFKRUIJER, LEVY JOEL HANGJAS², JOEL JOSEPH HANGJAS¹*) was born 27 Jun 1970 in Gisborne. She married PAUL ELSOM 17 Mar 2003 in Snells Beach. He was born Nov in Auckland.

Child of JOANNE HANDRICKS and PAUL ELSOM is:

- i. TOBY ASHTON¹⁰ ELSOM, b. 14 Jul 2004.

122. VICTORIA LYNNE⁹ FOGAL (*YVONNE IRENE⁸ HANDRICKS, DOUGLAS HUBERT NELSON⁷, NORMAN (NORRIE) FREDERICK JAMES⁶, JOZEF LEVI⁵, LEVIE JOSEPH JOZALE⁴ HANGJAS, JOSEPH JOZALE ABRAHAM HANGJAS³ TURFKRUIJER, LEVY JOEL HANGJAS², JOEL JOSEPH HANGJAS¹*) was born 04 Oct 1958 in California. She married (1) STEPHEN ROCKER 1977. She married (2) RONALD PATTERSON 1987.

Child of VICTORIA FOGAL and STEPHEN ROCKER is:

- 141. i. SHANON¹⁰ ROCKER, b. 24 Aug 1977.

Children of VICTORIA FOGAL and RONALD PATTERSON are:

- 142. ii. JUANNE¹⁰ PATTERSON.
- iii. KIRSTY PATTERSON, b. 1990, Torrance, CA.
- iv. COURTNEY PATTERSON.

123. RAYMIE PAUL⁹ FOGAL (*YVONNE IRENE⁸ HANDRICKS, DOUGLAS HUBERT NELSON⁷, NORMAN (NORRIE) FREDERICK JAMES⁶, JOZEF LEVI⁵, LEVIE JOSEPH JOZALE⁴ HANGJAS, JOSEPH JOZALE ABRAHAM HANGJAS³ TURFKRUIJER, LEVY JOEL HANGJAS², JOEL JOSEPH HANGJAS¹*) was born 04 Apr 1961 in Hawthorne, Ca. He met (1) SHERYL MATTHEWS. He married (2) SHAUNA LORRAINE MCAFEE 03 Mar 1989. She was born 26 May 1966 in Red Deer, Alberta.

Child of RAYMIE FOGAL and SHERYL MATTHEWS is:

- i. ROBERT BURTON¹⁰ FOGAL, b. 05 Jun 1987.

Child of RAYMIE FOGAL and SHAUNA MCAFEE is:

- ii. RYAN TERRY¹⁰ FOGAL, b. 31 Dec 1998, California.

124. STEVEN LEE⁹ ROWIN (*YVONNE IRENE⁸ HANDRICKS, DOUGLAS HUBERT NELSON⁷, NORMAN (NORRIE) FREDERICK JAMES⁶, JOZEF LEVI⁵, LEVIE JOSEPH JOZALE⁴ HANGJAS, JOSEPH JOZALE ABRAHAM HANGJAS³ TURFKRUIJER, LEVY JOEL HANGJAS², JOEL JOSEPH HANGJAS¹*) was born 09 Oct 1966 in California.

Child of STEVEN LEE ROWIN is:

- i. ASHLEE¹⁰ ROWIN.

125. WARWICK HUGH JOSEPH⁹ BUTCHER (*JOSEPHINE⁸ JOSEPH, MORRIS CEDRIC CLARE⁷, SARAH ELIZABET (LILY)⁶ HANDRICKS, JOZEF LEV⁵, LEVIE JOSEPH JOZALE⁴ HANGJAS, JOSEPH JOZALE ABRAHAM HANGJAS³ TURFKRUIJER, LEVY JOEL HANGJAS², JOEL JOSEPH HANGJAS¹*) was born 16 Feb 1947. He married MARGARET ANNE POTTER. She was born 09 Aug 1945.

Children of WARWICK BUTCHER and MARGARET POTTER are:

- i. DARRELL ANTONY STEWART¹⁰ BUTCHER, b. 21 Jul 1970.
143. ii. MARTIN LEE CAMERON BUTCHER, b. 15 Sep 1972.
- iii. ALAN LESLIE ROY BUTCHER, b. 03 Jun 1977.

126. CHRISTINE LESLEY⁹ BUTCHER (*JOSEPHINE⁸ JOSEPH, MORRIS CEDRIC CLARE⁷, SARAH ELIZABET (LILY)⁶ HANDRICKS, JOZEF LEV⁵, LEVIE JOSEPH JOZALE⁴ HANGJAS, JOSEPH JOZALE ABRAHAM HANGJAS³ TURFKRUIJER, LEVY JOEL HANGJAS², JOEL JOSEPH HANGJAS¹*) was born 23 Aug 1948. She married (1) WILLIAM MURPHY. He was born 20 Nov 1947. She married (2) SPENCLEY CURTIS. He was born 07 Feb 1950.

Child of CHRISTINE BUTCHER and WILLIAM MURPHY is:

- i. SUSAN JOY¹⁰ MURPHY, b. 30 Jul 1971.

Children of CHRISTINE BUTCHER and SPENCLEY CURTIS are:

- ii. JOANNE LESLEY¹⁰ CURTIS, b. 26 Feb 1980.
- iii. SALLY ANNE CURTIS, b. 24 Nov 1986.

127. FREDERICK JOHN MARSHALL⁹ BUTCHER (*JOSEPHINE⁸ JOSEPH, MORRIS CEDRIC CLARE⁷, SARAH ELIZABET (LILY)⁶ HANDRICKS, JOZEF LEV⁵, LEVIE JOSEPH JOZALE⁴ HANGJAS, JOSEPH JOZALE ABRAHAM HANGJAS³ TURFKRUIJER, LEVY JOEL HANGJAS², JOEL JOSEPH HANGJAS¹*) was born 26 May 1958. He married JANETT MAY ECCLES. She was born 03 Dec 1959.

Child of FREDERICK BUTCHER and JANETT ECCLES is:

- i. SHONA LESLEY¹⁰ BUTCHER, b. 03 Feb 1992.

128. ROGER LEWIS⁹ JOSEPH (*BERESFORD (BERRY) CLARE⁸, MORRIS CEDRIC CLARE⁷, SARAH ELIZABET (LILY)⁶ HANDRICKS, JOZEF LEV⁵, LEVIE JOSEPH JOZALE⁴ HANGJAS, JOSEPH JOZALE ABRAHAM HANGJAS³ TURFKRUIJER, LEVY JOEL HANGJAS², JOEL JOSEPH HANGJAS¹*) was born Abt. 1951. He married MARIE DANIELS. She died Abt. 2006.

Child of ROGER JOSEPH and MARIE DANIELS is:

- i. TAMMY¹⁰ JOSEPH, b. 04 Jan 1985.

129. CHARMAINE ANNE⁹ JOSEPH (*BERESFORD (BERRY) CLARE⁸, MORRIS CEDRIC CLARE⁷, SARAH ELIZABET (LILY)⁶ HANDRICKS, JOZEF LEV⁵, LEVIE JOSEPH JOZALE⁴ HANGJAS, JOSEPH JOZALE ABRAHAM HANGJAS³ TURFKRUIJER, LEVY JOEL HANGJAS², JOEL JOSEPH HANGJAS¹*) was born 24 Oct 1952. She married PAUL GERARD MORRIS. He was born 13 Feb 1955.

Children of CHARMAINE JOSEPH and PAUL MORRIS are:

- i. JOSEPHINE PATRICIA¹⁰ MORRIS, b. 04 May 1979; m. SHANE ROBERT MCORMOND; b. 01 Mar 1966.
- ii. YVETTE LAURA MORRIS, b. 12 Nov 1990.
- iii. CHRISTOPHER PAUL MORRIS, b. 14 Apr 1993.

130. ROSEMARY JANE⁹ JOSEPH (*BERESFORD (BERRY) CLARE⁸, MORRIS CEDRIC CLARE⁷, SARAH ELIZABET (LILY)⁶ HANDRICKS, JOZEF LEV⁵, LEVIE JOSEPH JOZALE⁴ HANGJAS, JOSEPH JOZALE ABRAHAM HANGJAS³ TURFKRUIJER, LEVY JOEL HANGJAS², JOEL JOSEPH HANGJAS¹*) was born 12 Mar 1956. She married (1) EGON LEOPOLDSIEDER. She married (2) VICTOR TRUDEAU.

Children of ROSEMARY JOSEPH and EGON LEOPOLDSIEDER are:

144. i. KATHERYN¹⁰ LEOPOLDSIEDER, b. 23 Aug 1980.
- ii. ASHLEY LEOPOLDSIEDER.

131. JOHN LESLY⁹ MITCHELL (*ELIZABETH ISOBEL⁸ JOSEPH, MORRIS CEDRIC CLARE⁷, SARAH ELIZABET (LILY)⁶ HANDRICKS, JOZEF LEVI⁵, LEVIE JOSEPH JOZALE⁴ HANGJAS, JOSEPH JOZALE ABRAHAM HANGJAS³ TURFKRUIJER, LEVY JOEL HANGJAS², JOEL JOSEPH HANGJAS¹*) was born 29 Sep 1959. He married ROBYN ANNE STONEHAM. She was born 02 Jan 1962.

Child of JOHN MITCHELL and ROBYN STONEHAM is:

- i. ANDREW JOHN¹⁰ MITCHELL, b. 27 Jun 1987.

132. MICHAEL RONALD⁹ MITCHELL (*ELIZABETH ISOBEL⁸ JOSEPH, MORRIS CEDRIC CLARE⁷, SARAH ELIZABET (LILY)⁶ HANDRICKS, JOZEF LEVI⁵, LEVIE JOSEPH JOZALE⁴ HANGJAS, JOSEPH JOZALE ABRAHAM HANGJAS³ TURFKRUIJER, LEVY JOEL HANGJAS², JOEL JOSEPH HANGJAS¹*) was born 26 Jan 1962. He married MARGARET MARIE LAVATE. She was born 20 Mar 1963.

Children of MICHAEL MITCHELL and MARGARET LAVATE are:

- i. MATTHEW JAMES¹⁰ MITCHELL, b. 18 Aug 1997.
- ii. MARTIN THOMAS MITCHELL, b. 04 Jun 2001.

133. LEONARD WAYNE⁹ RYAN (*VALERIE VIOLET⁸ JOSEPH, MORRIS CEDRIC CLARE⁷, SARAH ELIZABET (LILY)⁶ HANDRICKS, JOZEF LEVI⁵, LEVIE JOSEPH JOZALE⁴ HANGJAS, JOSEPH JOZALE ABRAHAM HANGJAS³ TURFKRUIJER, LEVY JOEL HANGJAS², JOEL JOSEPH HANGJAS¹*) was born 31 Jan 1956. He married DOROTHY MARYANNE VAN EYSDEN. She was born 20 Apr 1958, and died 14 Jul 2004.

Children of LEONARD RYAN and DOROTHY VAN EYSDEN are:

145. i. VALENA GEORGINE¹⁰ RYAN, b. 11 May 1980.
- ii. ADAM STACY RYAN, b. 02 Apr 1983.
- iii. ASHLEA SUZANNE RYAN, b. 09 Aug 1986.

134. SUSAN LINDA⁹ RYAN (*VALERIE VIOLET⁸ JOSEPH, MORRIS CEDRIC CLARE⁷, SARAH ELIZABET (LILY)⁶ HANDRICKS, JOZEF LEVI⁵, LEVIE JOSEPH JOZALE⁴ HANGJAS, JOSEPH JOZALE ABRAHAM HANGJAS³ TURFKRUIJER, LEVY JOEL HANGJAS², JOEL JOSEPH HANGJAS¹*) was born 12 Feb 1957. She married ADRIAN MARK MARTIN. He was born 22 Jan 1954.

Children of SUSAN RYAN and ADRIAN MARTIN are:

146. i. JAMES ADRIAN¹⁰ MARTIN, b. 18 Sep 1976.
- ii. TERRY O'DELL MARTIN, b. 11 Dec 1979.
- iii. CARAH LOUISE MARTIN, b. 09 Aug 1984.
- iv. BECK MARTIN, b. 1981.
- v. JASON MARTIN, b. 1983.

135. NANCY JANE⁹ RYAN (*VALERIE VIOLET⁸ JOSEPH, MORRIS CEDRIC CLARE⁷, SARAH ELIZABET (LILY)⁶ HANDRICKS, JOZEF LEVI⁵, LEVIE JOSEPH JOZALE⁴ HANGJAS, JOSEPH JOZALE ABRAHAM HANGJAS³ TURFKRUIJER, LEVY JOEL HANGJAS², JOEL JOSEPH HANGJAS¹*) was born 01 Mar 1959. She married RUSSELL STEVEN BONNER. He was born 20 Mar 1961.

Child of NANCY RYAN and RUSSELL BONNER is:

- i. JESSICA ALLISON¹⁰ BONNER, b. 29 Nov 1995.

136. DONNA KAY⁹ RYAN (*VALERIE VIOLET⁸ JOSEPH, MORRIS CEDRIC CLARE⁷, SARAH ELIZABET (LILY)⁶ HANDRICKS, JOZEF LEVI⁵, LEVIE JOSEPH JOZALE⁴ HANGJAS, JOSEPH JOZALE ABRAHAM HANGJAS³ TURFKRUIJER, LEVY JOEL HANGJAS², JOEL JOSEPH HANGJAS¹*) was born 17 Nov 1962. She met GARRY JOHN JONES Bef. 1985. He was born 07 Sep 1953.

Child of DONNA RYAN and GARRY JONES is:

- i. JADE¹⁰ RYAN, b. 05 Sep 1991.

137. JEANINE MAY⁹ RYAN (*VALERIE VIOLET⁸ JOSEPH, MORRIS CEDRIC CLARE⁷, SARAH ELIZABET (LILY)⁶ HANDRICKS, JOZEF LEVI⁵, LEVIE JOSEPH JOZALE⁴ HANGJAS, JOSEPH JOZALE ABRAHAM HANGJAS³ TURFKRUIJER, LEVY JOEL HANGJAS², JOEL JOSEPH HANGJAS¹*) was born 17 Nov 1962. She married PETER JOHN (STANGER) ELLIOTT. He was born 13 Jul 1959.

Children of JEANINE RYAN and PETER ELLIOTT are:

- i. MATTHEW SLADE (STANGER)¹⁰ ELLIOTT, b. 15 May 1987.
- ii. RICKY JOHN STANGER, b. 01 Jun 1988; d. 04 Sep 1988.
- iii. CASSANDRA LOUISE (STANGER) ELLIOTT, b. 26 Sep 1989.

138. HENDRIKA⁹ HANGJAS (*ISRAEL LEENDERT⁸, JESAJA⁷, SAARTJE⁶, MOZES LEVI⁵, LEVIE JOSEPH JOZALE⁴, JOSEPH JOZALE ABRAHAM HANGJAS³ TURFKRUIJER, LEVY JOEL HANGJAS², JOEL JOSEPH HANGJAS¹*) was born 07 Dec 1921 in Amsterdam, and died 29 Jul 1942 in Auschwitz. She married ABRAM DE MESQUITA. He was born 30 Jun 1919 in Amsterdam, and died 30 Sep 1942 in Auschwitz.

Child of HENDRIKA HANGJAS and ABRAM DE MESQUITA is:

- i. JACOB¹⁰ DE MESQUITA, b. 17 Apr 1941, Amsterdam; d. 29 Jul 1942, Auschwitz.

139. KLARA⁹ HANGJAS (*ABRAHAM⁸, JESAJA⁷, SAARTJE⁶, MOZES LEVI⁵, LEVIE JOSEPH JOZALE⁴, JOSEPH JOZALE ABRAHAM HANGJAS³ TURFKRUIJER, LEVY JOEL HANGJAS², JOEL JOSEPH HANGJAS¹*) was born 10 May 1923 in Amsterdam, and died 19 Oct 1942 in Auschwitz. She married MAURITS ENGERS.

Child of KLARA HANGJAS and MAURITS ENGERS is:

- i. BERTHA¹⁰ ENGERS, b. 17 Feb 1942, Amsterdam; d. 19 Oct 1942, Auschwitz.

140. GREETJE⁹ HANGJAS (*JOHANNES WILHELMUS⁸, IZAAK JOSEF⁷, IZAAK JOSEF⁶, MAARTJE MARCUS⁵, MARCUS MORDECHAI JOSEPH JOZALE HANGJAS⁴ TURFKRUYE, JOSEPH JOZALE ABRAHAM HANGJAS³ TURFKRUIJER, LEVY JOEL HANGJAS², JOEL JOSEPH HANGJAS¹*) She married ? TETENBURG.

Child of GREETJE HANGJAS and ? TETENBURG is:

- i. ROBBIE¹⁰ TETENBURG.

Generation No. 10

141. SHANON¹⁰ ROCKER (*VICTORIA LYNNE⁹ FOGAL, YVONNE IRENE⁸ HANDRICKS, DOUGLAS HUBERT NELSON⁷, NORMAN (NORRIE) FREDERICK JAMES⁶, JOZEF LEVI⁵, LEVIE JOSEPH JOZALE⁴ HANGJAS, JOSEPH JOZALE ABRAHAM HANGJAS³ TURFKRUIJER, LEVY JOEL HANGJAS², JOEL JOSEPH HANGJAS¹*) was born 24 Aug 1977. She married TIMOTHY ?.

Child of SHANON ROCKER and TIMOTHY ? is:

- i. ?¹¹ ?.

142. JUANNE¹⁰ PATTERSON (*VICTORIA LYNNE⁹ FOGAL, YVONNE IRENE⁸ HANDRICKS, DOUGLAS HUBERT NELSON⁷, NORMAN (NORRIE) FREDERICK JAMES⁶, JOZEF LEVI⁵, LEVIE JOSEPH JOZALE⁴ HANGJAS, JOSEPH JOZALE ABRAHAM HANGJAS³ TURFKRUIJER, LEVY JOEL HANGJAS², JOEL JOSEPH HANGJAS¹*) She married RICHARD MILLER.

Child of JUANNE PATTERSON and RICHARD MILLER is:

- i. ?¹¹ MILLER.

143. MARTIN LEE CAMERON¹⁰ BUTCHER (*WARWICK HUGH JOSEPH⁹, JOSEPHINE⁸ JOSEPH, MORRIS CEDRIC CLARE⁷, SARAH ELIZABET (LILY)⁶ HANDRICKS, JOZEF LEVI⁵, LEVIE JOSEPH JOZALE⁴ HANGJAS, JOSEPH JOZALE ABRAHAM HANGJAS³ TURFKRUIJER, LEVY JOEL HANGJAS², JOEL JOSEPH HANGJAS¹*) was born 15 Sep 1972. He met JILL ELLEN HENDTLASS. She was born 01 Apr 1975.

Child of MARTIN BUTCHER and JILL HENDTLASS is:

- i. LACHLAN JAMES¹¹ BUTCHER, b. 25 Apr 2003.

144. KATHERYN¹⁰ LEOPOLDSEDER (*ROSEMARY JANE⁹ JOSEPH, BERESFORD (BERRY) CLARE⁸, MORRIS CEDRIC CLARE⁷, SARAH ELIZABET (LILY)⁶ HANDRICKS, JOZEF LEVI⁵, LEVIE JOSEPH JOZALE⁴ HANGJAS, JOSEPH JOZALE ABRAHAM HANGJAS³ TURFKRUIJER, LEVY JOEL HANGJAS², JOEL JOSEPH HANGJAS¹*) was born 23 Aug 1980. She married RICHARD HAWKINS 26 Nov 2005. He was born 24 Apr 1980.

Child of KATHERYN LEOPOLDSEDER and RICHARD HAWKINS is:

- i. ADAH¹¹ HAWKINS, b. 13 Feb 2009.

145. VALENA GEORGINE¹⁰ RYAN (*LEONARD WAYNE⁹, VALERIE VIOLET⁸ JOSEPH, MORRIS CEDRIC CLARE⁷, SARAH ELIZABET (LILY)⁶ HANDRICKS, JOZEF LEVI⁵, LEVIE JOSEPH JOZALE⁴ HANGJAS, JOSEPH JOZALE ABRAHAM HANGJAS³ TURFKRUIJER, LEVY JOEL HANGJAS², JOEL JOSEPH HANGJAS¹*) was born 11 May 1980. She married ASHLEIGH GLENN ROBBINS. He was born 20 May 1978.

Child of VALENA RYAN and ASHLEIGH ROBBINS is:

- i. ZACHARY KRISTIAN¹¹ ROBBINS, b. 21 Dec 2001.

146. JAMES ADRIAN¹⁰ MARTIN (*SUSAN LINDA⁹ RYAN, VALERIE VIOLET⁸ JOSEPH, MORRIS CEDRIC CLARE⁷, SARAH ELIZABET (LILY)⁶ HANDRICKS, JOZEF LEVI⁵, LEVIE JOSEPH JOZALE⁴ HANGJAS, JOSEPH JOZALE ABRAHAM HANGJAS³ TURFKRUIJER, LEVY JOEL HANGJAS², JOEL JOSEPH HANGJAS¹*) was born 18 Sep 1976. He met BROOK ?. She was born 24 Sep 1978.

Child of JAMES MARTIN and BROOK ? is:

- i. KAYLA PAGE¹¹ MARTIN, b. 09 Aug 1996.

Descendants of George Staggard

Generation No. 1

1. GEORGE¹ STAGGARD was born 1780 in Norfolk, England, and died 1849 in Southburg, Norfolk, United Kingdom. He married THOMASINE ?. She was born Abt. 1785 in Hingham, Norfolk, England, and died Abt. 1867 in Southburgh, Norfolk, England.

Children of GEORGE STAGGARD and THOMASINE ? are:

2. i. THOMAS² STAGGARD, b. 01 Jan 1814, Norfolk, England; d. 17 Jan 1886, Westbury, Tasmania.
- ii. JOHN STAGGARD, b. 1818, Hackford, Norfolk, England; m. ANNE ?; b. 1823, Hingham, Norfolk, England.
- iii. MARY STAGGARD, b. Abt. 1825.
- iv. ISAAC STAGGARD, b. Abt. 1840; d. 1845, Southburgh, Norfolk, England.
- v. ISAAC THOMAS STAGGARD, b. Jun 1848; d. 15 Jul 1847, Southburgh, Norfolk, England.

Generation No. 2

2. THOMAS² STAGGARD (*GEORGE*¹) was born 01 Jan 1814 in Norfolk, England, and died 17 Jan 1886 in Westbury, Tasmania. He married HANNAH SMITH 16 Nov 1837 in Westfield, Norfolk, England, daughter of JAMES SMITH and MARY COOPER. She was born 25 Oct 1816 in Seething, Norfolk, England, and died 04 Oct 1877 in Westbury.

Children of THOMAS STAGGARD and HANNAH SMITH are:

3. i. ARTHUR³ STAGGARD, b. 14 Aug 1858, Westbury, Tasmania, Australia; d. 04 Apr 1909, Clifton Hill, Borondara, Melbourne, Australia.
- ii. HANNAH STAGGARD, b. 03 Jul 1853, Norfolk England; d. 19 Oct 1926, Numurkah.
4. iii. ROBERT SYDNEY WALTER STAGGARD, b. 01 Jan 1843, Norfolk, England; d. 05 Jun 1896, Suicide, run over by a train near Glenferrie, Hawthorn.
5. iv. JOHN THOMAS STAGGARD, b. 17 Aug 1838, Norfolk, England; d. 12 Oct 1911, Hagley.
- v. ERNEST STAGGARD, b. 06 Sep.
6. vi. WILFRED STAGGARD.
- vii. THOMAS STAGGARD, b. 17 Nov 1856, Westbury, Tasmania, Australia; d. 17 Dec 1856, Westbury, Tasmania.
7. viii. GEORGE STAGGARD, b. 1841, Norfolk, England; d. 14 Dec 1874, Longford.
- ix. FRANCES STAGGARD, b. 1849; d. 14 Jan 1855, On board "Whirlwind" ship on trip to Australia.
- x. SARAH STAGGARD, b. 1853; d. 19 Dec 1854, On board "Whirlwind" ship on trip to Australia.
- xi. MARY STAGGARD, b. 26 Jul 1840, Southburgh, Norfolk, England.

Generation No. 3

3. ARTHUR³ STAGGARD (*THOMAS*², *GEORGE*¹) was born 14 Aug 1858 in Westbury, Tasmania, Australia, and died 04 Apr 1909 in Clifton Hill, Borondara, Melbourne, Australia. He married ROSE-ANNE HALDSWORTH 1884 in Tasmania, daughter of WILLIAM HALDSWORTH and ISABELLA GELLEY. She was born 27 Jun 1861 in Melbourne, Australia, and died 17 Oct 1926 in Gisborne.

Children of ARTHUR STAGGARD and ROSE-ANNE HALDSWORTH are:

8. i. RUBY FRANCES⁴ STAGGARD, b. 27 Feb 1885, Glenferrie, Victoria, Australia; d. 19 Jul 1989, St John's Hospital, Pah Rd, Epsom, Auckland.
- ii. LESLIE THOMAS STAGGARD, b. 22 Sep 1889, Hawthorn, Kooyong, Victoria, Australia; d. 28 Mar 1958, Auckland.
- iii. PERCIVAL ARTHUR STAGGARD, b. 22 Nov 1886, Hawthorn, Kooyong, Victoria, Australia; d. 31 Jan 1914, 145 Joel Terrace, Mt Lawley, Perth, Western Australia.

4. ROBERT SYDNEY WALTER³ STAGGARD (*THOMAS*², *GEORGE*¹) was born 01 Jan 1843 in Norfolk, England, and died 05 Jun 1896 in Suicide, run over by a train near Glenferrie, Hawthorn. He married LOUISA SHELDRAKE 12 Oct 1870 in Hawthorne, daughter of JONATHAN SHELDRAKE and ELIZABETH PIKE. She was born 14 Apr 1844 in Lambeth, Surrey, England, and died 01 Mar 1936 in Alexandra, Victoria, Australia.

Children of ROBERT STAGGARD and LOUISA SHELDRAKE are:

9. i. BERTHA GRACE⁴ STAGGARD, b. 21 Dec 1877, Hawthorn; d. 1964, Camberwell.
10. ii. ERNEST FREDERICK ARTHUR STAGGARD, b. 06 Sep 1871, Boro /Nathalia, Vic., Australia; d. 01 Jan 1958, Geelong Hospital, Victoria, Australia.
11. iii. AMY ROBERTA STAGGARD, b. 1873, Benandarah, Vic., Australia.
12. iv. EDITH MARY STAGGARD, b. 1873, Benandarah, Vic., Australia; d. 1924, South Melbourne.
13. v. LOUIS HERBERT (LAWRENCE) STAGGARD, b. 1879, Hawthorn; d. 1956, Fairfield, Melbourne.
14. vi. WALTER LESLIE THOMAS STAGGARD, b. 1881, Hawthorn; d. 1960, Kew, Melbourne.
14. vii. SYDNEY ROBERT STAGGARD, b. 1883, Hawthorn; d. 1885, Hawthorn.
15. viii. HUBERT EDWARD STAGGARD, b. 1886, Hawthorn; d. 1953, Mooroopna, Vic..Australia.
16. ix. JESSIE MURIEL DECIMA STAGGARD, b. 1888, Hawthorn; d. 1982, Narooma, New South Wales, Australia.
17. x. GEORGE CHARLES STAGGARD, b. 04 Dec 1874, Numurkah, Vic., Aust; d. 09 May 1948, Hawthorne.

5. JOHN THOMAS³ STAGGARD (*THOMAS*², *GEORGE*¹) was born 17 Aug 1838 in Norfolk, England, and died 12 Oct 1911 in Hagley. He married MARION TAIT ROBB 03 Jul 1877 in Private House, Hagley, The Church of Scotland in Tasmania, daughter of CHARLES ROBB and ISABELLA CLERKINS. She was born 27 Oct 1855 in Edinburgh, and died 13 Mar 1931 in Hagley.

Children of JOHN STAGGARD and MARION ROBB are:

- i. EDITH ROSE⁴ STAGGARD, b. 02 Dec 1888, Westbury; d. 05 May 1959, Hagley.
- ii. IDA LOUISE STAGGARD, b. 28 Dec 1877, Westbury; d. 23 Apr 1957, Hagley.
- iii. ALICE MAY STAGGARD, b. 12 May 1879, Westbury; d. 08 Aug 1958, Hagley.
- iv. EVELYN MARION STAGGARD, b. 18 Jun 1880, Westbury; d. 16 Apr 1949, Hagley.
18. v. CHARLES JOHN STAGGARD, b. 02 Dec 1881, Westbury; d. 1963, St Lukes, Launceston, Tasmania.
- vi. RHODA ELSIE STAGGARD, b. 11 Apr 1886, Westbury; d. 13 Nov 1912, Hagley.
- vii. IRENE AMELIA STAGGARD, b. 26 Jul 1891, Westbury, Tasmania; d. 21 Jul 1959, Eskleigh, Perth.
19. viii. ARTHUR JAMES STAGGARD, b. 28 Feb 1883, Westbury; d. Nov 1956, Altona, Melbourne.

6. WILFRED³ STAGGARD (*THOMAS*², *GEORGE*¹) He married MAY A ?. She was born 12 May.

Child of WILFRED STAGGARD and MAY ? is:

- i. ROBERT⁴ STAGGARD, b. 05 May.

7. GEORGE³ STAGGARD (*THOMAS*², *GEORGE*¹) was born 1841 in Norfolk, England, and died 14 Dec 1874 in Longford. He married MARGARET AMELIA SUMMERS 1870 in Longford, Tasmania, Australia, daughter of JAMES SUMMERS and ELIZABETH FLOOD. She was born 04 Oct 1851 in McRaes Hill, Longford, Tasmania, Australia, and died 24 Jul 1870 in Longford.

Child of GEORGE STAGGARD and MARGARET SUMMERS is:

20. i. ALFRED HENRY ADOLPHUS⁴ STAGGARD, b. 10 Feb 1870, Longford, Tasmania, Australia; d. 08 Sep 1946, Tower Hill Rd, Delorame.

Generation No. 4

8. RUBY FRANCES⁴ STAGGARD (*ARTHUR*³, *THOMAS*², *GEORGE*¹) was born 27 Feb 1885 in Glenferrie, Victoria, Australia, and died 19 Jul 1989 in St John's Hospital, Pah Rd, Epsom, Auckland. She married (1) NORMAN (NORRIE) FREDERICK JAMES HANDRICKS 06 Dec 1911 in Christian Chapel, Church of Christ, Hawthorn, Victoria, Australia, son of JOZEF HANDRICKS and SARAH MCKENNA. He was born 06 Dec 1879 in Port Fairy, Victoria, Australia, and died 04 Sep 1936 in Auckland. She married (2) JAMES GAM GOON LEE 1953, son of JAMES LEE and EMILY NEAL. He was born 25 Sep 1880 in Ashburton, Canterbury, New Zealand, and died 21 May 1960 in Auckland.

Children of RUBY STAGGARD and NORMAN HANDRICKS are:

21. i. EDWIN (EDDIE) LISTER⁵ HANDRICKS, b. 05 Mar 1926, Lister Hospital, Riverside Road, Gisborne; d. 01 May 2011, Middlemore Hospital, Auckland.
- ii. GWENDOLINE ROSE CORRICK HANDRICKS, b. 03 Oct 1912, Granville, Sydney; d. 02 Nov 2000, Auckland Hospital, Auckland, New Zealand.
22. iii. ROBERT HARRY HANDRICKS, b. 08 Apr 1920, Gisborne; d. 07 Aug 2007, Dargaville.
23. iv. NORMAN LESLIE HANDRICKS, b. 19 Sep 1915, Wellington; d. 27 Jan 2004, Whakatane.
24. v. DOUGLAS HUBERT NELSON HANDRICKS, b. 25 Aug 1917, Nelson; d. 09 May 1981, Sydney.
- vi. WILLIAM HANDRICKS, b. 08 Apr 1920, Gisborne; d. 08 Apr 1920, Gisborne.

9. BERTHA GRACE⁴ STAGGARD (*ROBERT SYDNEY WALTER*³, *THOMAS*², *GEORGE*¹) was born 21 Dec 1877 in Hawthorn, and died 1964 in Camberwell. She married ARTHUR ALBERT COOK. He was born 1869 in Sebastapol, Vic., Australia, and died 1938 in Richmond, Melbourne.

Children of BERTHA STAGGARD and ARTHUR COOK are:

- i. RONALD ARTHUR⁵ COOK, b. 1912, Hawthorn; d. 1919, East Melbourne.
25. ii. PHYLLS MOIRA COOK, b. 1914, Hawthorn.
26. iii. NORMAN ARTHUR COOK, b. 1919; d. 1972, Burwood, Melbourne.

10. ERNEST FREDERICK ARTHUR⁴ STAGGARD (*ROBERT SYDNEY WALTER*³, *THOMAS*², *GEORGE*¹) was born 06 Sep 1871 in Boro /Nathalia, Vic., Australia, and died 01 Jan 1958 in Geelong Hospital, Victoria, Australia. He married EMILY EVA COX 07 Sep 1904 in Hawthorn Home. She was born 19 Jul 1883 in Portalington, Vic, Australia, and died 21 Dec 1938 in St. Vincents Hosp. Melbourne, Vic, Australia.

Children of ERNEST STAGGARD and EMILY COX are:

27. i. FREDERICK GEORGE⁵ STAGGARD, b. 05 Jun 1905, Hawthorn; d. 14 Sep 1980, Box Hill, Melbourne.
28. ii. THOMAS JOHN STAGGARD, b. 26 Jan 1908, Bellarine East, Vic, Australia; d. 28 Dec 1974, Repatriation Hospital, Melbourne.
29. iii. WALTER LOUIS (WALT) STAGGARD, b. 26 Jun 1910, Portalington, Vic, Australia; d. 12 Oct 1997, Oakleigh, Melbourne.
30. iv. LESLIE ARTHUR EARNEST (LES) STAGGARD, b. 12 Sep 1913, Portalington, Vic, Australia; d. 04 Jul 1987, Mulgrave, Melbourne.
31. v. MYRTLE ADEL STAGGARD, b. 24 Jul 1916, Portalington, Vic, Australia; d. 29 May 1983, Lara, Vic., Australia.
32. vi. KATHLEEN ALICE STAGGARD, b. 11 Nov 1920, West Geelong.

11. AMY ROBERTA⁴ STAGGARD (*ROBERT SYDNEY WALTER*³, *THOMAS*², *GEORGE*¹) was born 1873 in Benandarah, Vic., Australia. She married EDWIN EDWARDS. He was born Abt. 1872 in Wales.

Children of AMY STAGGARD and EDWIN EDWARDS are:

- i. MURIEL GLADYS⁵ EDWARDS, b. 1897, Hawthorn.
- ii. ERNEST GEMBROOK EDWARDS, b. 1899, Hawthorn; d. 1934, Melbourne.
- iii. LESLIE ROBERT EDWARDS, b. 1902, Gembrook, Australia.
33. iv. THELMA EDWARDS, b. 1903.
- v. FLORENCE RUBY EDWARDS, b. 1905, Emerald, Vic. Australia; d. 1907, Emerald, Vic. Australia.

12. EDITH MARY⁴ STAGGARD (*ROBERT SYDNEY WALTER*³, *THOMAS*², *GEORGE*¹) was born 1873 in Benandarah, Vic., Australia, and died 1924 in South Melbourne. She married EDWIN BRAME 29 Apr 1905 in Hawthorne. He was born 1857 in Geelong, Victoria, Australia, and died 1932 in East Melbourne.

Children of EDITH STAGGARD and EDWIN BRAME are:

- i. LESLIE⁵ BRAME.
- ii. GLADYS BRAME.
- iii. THELMA MYRTLE BRAME, b. 1906, Hawthorn; d. 1976, Kew, Melbourne; m. ? BURNS.
- iv. CLARENCE EDWARD BRAME, b. 1911, Richmond, Melbourne; d. 1911, Hawthorn.

13. LOUIS HERBERT (LAWRENCE)⁴ STAGGARD (*ROBERT SYDNEY WALTER*³, *THOMAS*², *GEORGE*¹) was born 1879 in Hawthorn, and died 1956 in Fairfield, Melbourne. He married CATHERINE (KATIE) PETTIT 15 Apr 1910 in Hawthorn, daughter of JOHN PETTIT. She was born 1886 in Bendigo, and died 1969 in Box Hill, Melbourne.

Children of LOUIS STAGGARD and CATHERINE PETTIT are:

- i. VALERIE⁵ STAGGARD, m. JOHN STEWART.
- ii. LAWRENCE STAGGARD.
34. iii. JOHN HERBERT JAMES (JACK) STAGGARD, b. 18 Aug 1910, Hawthorn; d. 20 Aug 1992.
- iv. RUPERT HENRY STAGGARD, b. 1912, Richmond, Melbourne; d. 1992.
- v. KENNETH LES MERVYN STAGGARD, b. 1917, Natimuk, Vic. Australia.
- vi. JOYCE CATHERINE STAGGARD, b. 1920, Hawthorn; m. ALEXANDER ARTHUR MCMORRIN, 1941, East Kew, Victoria, Australia; b. 21 Aug 1920, Kew Victoria.

14. WALTER LESLIE THOMAS⁴ STAGGARD (*ROBERT SYDNEY WALTER*³, *THOMAS*², *GEORGE*¹) was born 1881 in Hawthorn, and died 1960 in Kew, Melbourne. He married EDITH PITT WALDRON 1904 in Hawthorn. She was born 1878 in Worcester, UK, and died 1961 in Mord, Australia.

Children of WALTER STAGGARD and EDITH WALDRON are:

- i. ROBERT WALTER (BOBBIE)⁵ STAGGARD, b. 1905, Hawthorn.
- ii. HERBERT ROMNEY STAGGARD, b. 1906, Hawthorne; d. 1977, Heidelberg, Melbourne.
35. iii. EDITH MURIEL STAGGARD, b. 1907.
- iv. ELINOR ROSE STAGGARD, b. 1909; m. ? GASON.
- v. DOROTHY MAY STAGGARD, b. 1910, Hawthorn; d. 1977, Surrey Hills, Melbourne.
- vi. PHILLIP MERVYN STAGGARD, b. 1911, Hawthorn; d. 1913, Carlton, Melbourne.
36. vii. JESSIE PHYLLIS STAGGARD, b. 1913, Hawthorn; d. 1972, Box Hill, Melbourne.
37. viii. PHOEBIE CLORINDA STAGGARD, b. 1915, Hawthorn; d. 1943, Heidelberg, Melbourne.
- ix. ROSE ELIZABETH (ROSIE) STAGGARD, b. 1917, Hawthorn; m. ? CLEMON.
- x. ELSIE GERTRUDE (NELLIE) STAGGARD, b. 1919, Hawthorn; d. 1975, Prahran, Melbourne.
38. xi. DAVID STAGGARD.
- xii. PHYLLIS STAGGARD.

15. HUBERT EDWARD⁴ STAGGARD (*ROBERT SYDNEY WALTER*³, *THOMAS*², *GEORGE*¹) was born 1886 in Hawthorn, and died 1953 in Mooropna, Vic..Australia. He married (1) ANNE WRATHALL 13 Jul 1909 in Bealiba, Vic. Australia, daughter of WILLIAM WRATHALL and MARY LOVELL. She was born 1889 in Victoria, and died 1938 in Malvern, Victoria. He married (2) ROSE MAGGIE GRANT 1929 in Victoria, Australia. She was born 1889 in Broadmeadows, Victoria, and died 1974 in Deepdene, Victoria, Australia.

Children of HUBERT STAGGARD and ANNE WRATHALL are:

- i. ETHEL MARY LOUISA⁵ STAGGARD, b. 28 Apr 1910, Stratford, New Zealand; d. 1994.
- ii. FREDERICK WILLIAM STAGGARD, b. 1915, Waimate Plains, Taranaki, New Zealand; d. 1989, Geraldton, WA; Stepchild.
39. iii. HERBERT EDWARD STAGGARD, b. 1912, Bealiba, Vic. Australia; d. 1965, Heidelberg, Melbourne; Stepchild.
40. iv. HANNAH JESSIE STAGGARD, b. 1920, Warrambool; Stepchild.

16. JESSIE MURIEL DECIMA⁴ STAGGARD (*ROBERT SYDNEY WALTER*³, *THOMAS*², *GEORGE*¹) was born 1888 in Hawthorn, and died 1982 in Narooma, New South Wales, Australia. She married EDWARD HENRY KROSCHER 1916, son of CHARLES KROSCHER and MARY KING. He was born 1889 in Horsham, Victoria, and died 1977 in Narooma, New South Wales, Australia.

Children of JESSIE STAGGARD and EDWARD KROSCHER are:

- i. BRENDA JOYCE⁵ KROSCHER, b. 14 Apr 1917, Yea, Vic., Australia; m. ? GLENISTER.
- ii. EDWARD MAXFIELD KROSCHER, b. 27 Apr 1920, Mansfield, Victoria; d. 18 Jan 1945, Borneo, Malaysia.

17. GEORGE CHARLES⁴ STAGGARD (*ROBERT SYDNEY WALTER*³, *THOMAS*², *GEORGE*¹) was born 04 Dec 1874 in Numurkah, Vic., Aust, and died 09 May 1948 in Hawthorne. He married MARY WHITE ELLIS 23 Sep 1903 in Hawthorne, daughter of PASCOE ELLIS and MARY PARSONS. She was born 11 May 1880 in Churches Flat, Fryerstown, Vic., Australia, and died 06 Oct 1964 in Burwood, Melbourne.

Children of GEORGE STAGGARD and MARY ELLIS are:

41. i. CECIL VERNON⁵ STAGGARD, b. 08 Mar 1904, Bairnsdale, Vic.; d. 26 Jul 1979, Nobel park, Melbourne.
- ii. SYDNEY ROBERT STAGGARD, b. 30 Sep 1905, Numurkah; d. 03 Oct 1905, Numurkah.
42. iii. ROBERT ERNEST ARTHUR PASCOE STAGGARD, b. 28 Mar 1907, Numurkah; d. 04 Jul 1998, Numurkah.
43. iv. MARIE IRENE LOUISA STAGGARD, b. 30 Apr 1909, Shepparton; d. 13 Sep 1999, Burwood, Melbourne.
44. v. ELLIS GEORGE (SPIKE) STAGGARD, b. 04 Jul 1911, Numurkah; d. 05 May 1984, Heidelberg Repat Hospital.
45. vi. ALLAN LINDSAY STAGGARD, b. 15 Jun 1913, Numurkah.
46. vii. HANNAH KRITHIA JEAN STAGGARD, b. 08 Sep 1915, Numurkah.
47. viii. ALFRED JOHN (BUCKLE) STAGGARD, b. 19 Feb 1918, Numurkah; d. 18 Jun 1972, Echuca, Vic., Australia.
- ix. PETER KEITH STAGGARD, b. 08 Mar 1920, Numurkah; d. 03 Mar 1942, Ararat.
- x. ALBERT EDWIN JAMES STAGGARD, b. 04 Nov 1922, Numurkah; m. MONA MARVE, 16 Feb 1946; b. 14 May 1917, Burwood, Melbourne.

18. CHARLES JOHN⁴ STAGGARD (*JOHN THOMAS*³, *THOMAS*², *GEORGE*¹) was born 02 Dec 1881 in Westbury, and died 1963 in St Lukes, Launceston, Tasmania. He married EMILINE FLORENCE TABER, daughter of CHARLES TABER and EMILINE WILLIAMS. She was born 09 Jan 1888 in Longford, Tasmania, and died 17 Sep 1959 in Longford.

Children of CHARLES STAGGARD and EMILINE TABER are:

48. i. MARJORIE⁵ STAGGARD, b. 1913; d. 1961.
- ii. LORNA GERTRUDE STAGGARD, b. 24 Jan 1917; d. 1976; m. HAROLD WILLIAM WOOLNOUGH; b. 1910; d. 1974.
49. iii. JOYCE MURIEL STAGGARD, b. 23 Aug 1919; d. 15 Jan 1992, Launceston.
50. iv. DON WHILEY STAGGARD, b. 01 Mar 1932.
51. v. GWENDOLINE IRIS (GWEN) STAGGARD, b. 15 Sep 1920; d. 17 Nov 1985, Launceston.

19. ARTHUR JAMES⁴ STAGGARD (*JOHN THOMAS*³, *THOMAS*², *GEORGE*¹) was born 28 Feb 1883 in Westbury, and died Nov 1956 in Altona, Melbourne. He married DORIS EVELINE FREE 26 Jun 1912 in Hobart, daughter of THOMAS FREE and EVANGELINE TAYLOR. She was born 08 Dec 1891 in Clarence, Tasmania, Australia, and died 1972 in Preston, Melbourne.

Children of ARTHUR STAGGARD and DORIS FREE are:

52. i. JOHN ARTHUR⁵ STAGGARD, b. 21 Feb 1913; d. 1973, Melbourne.
53. ii. EDNA MAY STAGGARD, b. 12 Apr 1914.
54. iii. ROY ARTHUR JAMES STAGGARD, b. 04 Dec 1930.

20. ALFRED HENRY ADOLPHUS⁴ STAGGARD (*GEORGE*³, *THOMAS*², *GEORGE*¹) was born 10 Feb 1870 in Longford, Tasmania, Australia, and died 08 Sep 1946 in Tower Hill Rd, Deloraine. He married IDONIA ELVIE TURNER 26 Dec 1899 in Campbell Town Milford C of E, daughter of WILLIAM TURNER and MARY YOUL. She was born 1876 in Brambletye, Avoca, and died 19 Jun 1966 in Launceston.

Children of ALFRED STAGGARD and IDONIA TURNER are:

- i. GEORGE⁵ STAGGARD, b. 1904; d. 14 Jul 1910.
- ii. GLADYS STAGGARD, b. 1906; d. Aft. 1912.
- iii. CELIA (CEIL) MARY STAGGARD, b. 22 Mar 1908, Epping Forest; m. JOHN (JACK) BOXHALL, 09 Apr 1930, Deloraine; b. 04 May 1904; d. 01 Mar 1969, Launceston.
55. iv. GEOFFREY ROBERT STAGGARD, b. 28 Apr 1910, Launceston, Tasmania; d. 08 Sep 1992, Devonport Tasmania.
56. v. RHODA ELVIE STAGGARD, b. 05 Nov 1912; d. 05 Jul 1994.
57. vi. CLEM VERDUN STAGGARD, b. 18 Sep 1916, Campbell Town.

Generation No. 5

21. EDWIN (EDDIE) LISTER⁵ HANDRICKS (*RUBY FRANCES*⁴ STAGGARD, *ARTHUR*³, *THOMAS*², *GEORGE*¹) was born 05 Mar 1926 in Lister Hospital, Riverside Road, Gisborne, and died 01 May 2011 in Middlemore Hospital, Auckland. He married NORMA MARGARET LOUISA HARRIS 31 Oct 1953 in 2:00pm St Davids Church, Naenae, Wellington, daughter of FREDERICK HARRIS and MARGARET VALENTINE. She was born 12 Jan 1930 in Alexandra Nursing Home, 28 Hanson Street, Newtown, Wellington, and died 11 Dec 2011 in St Andrews Hospital, Glendowie, Auckland.

Children of EDWIN HANDRICKS and NORMA HARRIS are:

58. i. IAN LISTER⁶ HANDRICKS, b. 06 Jul 1955, At Home, 9 Farringdon St, Glen Innes, Auckland.
59. ii. LYNETTE MARGARET HANDRICKS, b. 02 Jul 1957, At Home, 9 Farringdon St, Glen Innes, Auckland.
60. iii. GLENN PETER HANDRICKS, b. 03 Mar 1966, Middlemore Hospital, Auckland.

22. ROBERT HARRY⁵ HANDRICKS (*RUBY FRANCES⁴ STAGGARD, ARTHUR³, THOMAS², GEORGE¹*) was born 08 Apr 1920 in Gisborne, and died 07 Aug 2007 in Dargaville. He married KATHLEEN GLADYS MAY HOWELLS 1956, daughter of STEPHEN HOWELLS and MAUD YOUNG. She was born 27 Jun 1927 in NZ, and died 19 Oct 1989 in Auckland.

Children of ROBERT HANDRICKS and KATHLEEN HOWELLS are:

61. i. LINDA MAY⁶ HANDRICKS, b. 11 Sep 1962.
- ii. DIANE FRANCES HANDRICKS, b. 02 May 1960; m. LIONEL LOZA.

23. NORMAN LESLIE⁵ HANDRICKS (*RUBY FRANCES⁴ STAGGARD, ARTHUR³, THOMAS², GEORGE¹*) was born 19 Sep 1915 in Wellington, and died 27 Jan 2004 in Whakatane. He married PEGGY DOREEN MOSEN 1943, daughter of JAMES MOSEN and BEATRICE BOWLES. She was born 17 Apr 1923 in Masterton, and died 30 Jun 2014 in Whakatane.

Children of NORMAN HANDRICKS and PEGGY MOSEN are:

62. i. PAUL⁶ HANDRICKS, b. 23 Mar 1944, Masterton.
- ii. SHIRLEY HANDRICKS, b. 30 Jan 1959.

24. DOUGLAS HUBERT NELSON⁵ HANDRICKS (*RUBY FRANCES⁴ STAGGARD, ARTHUR³, THOMAS², GEORGE¹*) was born 25 Aug 1917 in Nelson, and died 09 May 1981 in Sydney. He met (1) MAUVA BERYL CLEMENTS 1940, daughter of EDGAR CLEMENTS and VIOLET CLARIDGE. She was born 22 Jul 1921 in Nelson, New Zealand, and died Jul 1968 in Akron NY USA. He married (2) FREDA BARBARA SPILSBURY 1946 in New Zealand, daughter of JOHN SPILSBURY and EDNA THORNE. She was born 03 Apr 1922 in St Helens Hospital, Auckland, New Zealand, and died Mar 1989 in Sydney, New South Wales, Australia.

Children of DOUGLAS HANDRICKS and MAUVA CLEMENTS are:

63. i. YVONNE IRENE⁶ HANDRICKS, b. 29 Dec 1940, Auckland.
- ii. ? HANDRICKS, b. 29 Dec 1940, Auckland; d. 29 Dec 1940, Auckland.

25. PHYLLS MOIRA⁵ COOK (*BERTHA GRACE⁴ STAGGARD, ROBERT SYDNEY WALTER³, THOMAS², GEORGE¹*) was born 1914 in Hawthorn. She married KELVIN LOMAS.

Children of PHYLLS COOK and KELVIN LOMAS are:

- i. HAYDN RUSSELL⁶ LOMAS, b. 1946.
- ii. TREVOR MALCOLM LOMAS, b. 1947; d. 1994.

26. NORMAN ARTHUR⁵ COOK (*BERTHA GRACE⁴ STAGGARD, ROBERT SYDNEY WALTER³, THOMAS², GEORGE¹*) was born 1919, and died 1972 in Burwood, Melbourne. He married MOLLY ?.

Children of NORMAN COOK and MOLLY ? are:

- i. JANNETTE⁶ COOK.
- ii. DAVID COOK.

27. FREDERICK GEORGE⁵ STAGGARD (*ERNEST FREDERICK ARTHUR⁴, ROBERT SYDNEY WALTER³, THOMAS², GEORGE¹*) was born 05 Jun 1905 in Hawthorn, and died 14 Sep 1980 in Box Hill, Melbourne. He married MABEL MAUDE DAVIES 05 Sep 1933 in Geelong. She was born 1904, and died 24 Oct 1980.

Children of FREDERICK STAGGARD and MABEL DAVIES are:

64. i. JENNIFER MARY⁶ STAGGARD, b. 18 May 1934.
65. ii. JOHN FREDERICK STAGGARD, b. 13 Mar 1941.

28. THOMAS JOHN⁵ STAGGARD (*ERNEST FREDERICK ARTHUR⁴, ROBERT SYDNEY WALTER³, THOMAS², GEORGE¹*) was born 26 Jan 1908 in Bellarine East, Vic, Australia, and died 28 Dec 1974 in Repatriation Hospital, Melbourne. He married HAZEL ERNESTINE ROSE 21 Jun 1936. She was born 18 Jun 1909, and died 1973 in Hastings, Vic., Australia.

Children of THOMAS STAGGARD and HAZEL ROSE are:

- i. DIANE⁶ STAGGARD, b. 16 Mar 1940; m. FRANK CORBETT.
66. ii. GLYNN THOMAS EWARD STAGGARD, b. 16 Sep 1944.

29. WALTER LOUIS (WALT)⁵ STAGGARD (*ERNEST FREDERICK ARTHUR⁴, ROBERT SYDNEY WALTER³, THOMAS², GEORGE¹*) was born 26 Jun 1910 in Portalington, Vic, Australia, and died 12 Oct 1997 in Oakleigh, Melbourne. He married HAZEL MAY ELLEN 06 Apr 1940. She was born 20 Apr 1906.

Children of WALTER STAGGARD and HAZEL ELLEN are:

67. i. VICTOR⁶ STAGGARD, b. 02 Jul 1942.
68. ii. IAN STAGGARD, b. 05 Mar 1944.
69. iii. MARGARET ANN STAGGARD, b. 21 Oct 1947.

30. LESLIE ARTHUR EARNEST (LES)⁵ STAGGARD (*ERNEST FREDERICK ARTHUR⁴, ROBERT SYDNEY WALTER³, THOMAS², GEORGE¹*) was born 12 Sep 1913 in Portalington, Vic, Australia, and died 04 Jul 1987 in Mulgrave, Melbourne. He married DORIS MAY GALLPEN 08 Dec 1945. She was born 12 Feb 1925.

Children of LESLIE STAGGARD and DORIS GALLPEN are:

- i. DARREN LESLIE⁶ STAGGARD, b. 06 Apr 1963; m. JANET TINNING, 23 Oct 1994, Echuca.
- ii. RODNEY PAUL STAGGARD, b. 17 Dec 1965.

31. MYRTLE ADEL⁵ STAGGARD (*ERNEST FREDERICK ARTHUR⁴, ROBERT SYDNEY WALTER³, THOMAS², GEORGE¹*) was born 24 Jul 1916 in Portalington, Vic, Australia, and died 29 May 1983 in Lara, Vic., Australia. She married MALCOLM SEWARD HOOPER 09 Jan 1938 in Geelong, son of MALCOLM HOOPER and IDA NAIRN. He was born 02 Mar 1913 in Leopold, Victoria, and died 06 Jul 2003 in Yarrawonga, Victoria.

Children of MYRTLE STAGGARD and MALCOLM HOOPER are:

70. i. KATHLEEN LYNETTE⁶ HOOPER, b. 21 Oct 1938.
71. ii. MALCOLM ROSS HOOPER, b. 13 May 1940.
72. iii. NOEL LESLIE JOSEPH HOOPER, b. 01 Dec 1941.
73. iv. GARRY MAXWELL HOOPER, b. 30 Mar 1945.

32. KATHLEEN ALICE⁵ STAGGARD (*ERNEST FREDERICK ARTHUR⁴, ROBERT SYDNEY WALTER³, THOMAS², GEORGE¹*) was born 11 Nov 1920 in West Geelong. She married ALAN WHITTEN 21 Dec 1940 in Melbourne. He was born 14 Mar 1920, and died 11 Apr 1987 in Geelong, Victoria, Australia.

Children of KATHLEEN STAGGARD and ALAN WHITTEN are:

74. i. ALAN⁶ WHITTEN, b. 09 Jan 1943.
75. ii. ROBIN WHITTEN, b. 17 Sep 1949.

33. THELMA⁵ EDWARDS (*AMY ROBERTA⁴ STAGGARD, ROBERT SYDNEY WALTER³, THOMAS², GEORGE¹*) was born 1903. She married ALBERT EDWARD TEW.

Children of THELMA EDWARDS and ALBERT TEW are:

- i. EDWARD THOMAS ANZAC VICTOR⁶ TEW, b. 1919, Carlton, Melbourne.
- ii. PEGGY THELMA PEACE TEW, b. 1920, Carlton, Melbourne.

34. JOHN HERBERT JAMES (JACK)⁵ STAGGARD (*LOUIS HERBERT (LAWRENCE)⁴, ROBERT SYDNEY WALTER³, THOMAS², GEORGE¹*) was born 18 Aug 1910 in Hawthorn, and died 20 Aug 1992. He married JEAN ?.

Child of JOHN STAGGARD and JEAN ? is:

- i. CHERYL⁶ STAGGARD.

35. EDITH MURIEL⁵ STAGGARD (*WALTER LESLIE THOMAS⁴, ROBERT SYDNEY WALTER³, THOMAS², GEORGE¹*) was born 1907. She married HORACE WOODMAN. He was born Abt. 1900.

Child of EDITH STAGGARD and HORACE WOODMAN is:

- i. JILL⁶ WOODMAN, b. Abt. 1942.

36. JESSIE PHYLLIS⁵ STAGGARD (*WALTER LESLIE THOMAS⁴, ROBERT SYDNEY WALTER³, THOMAS², GEORGE¹*) was born 1913 in Hawthorn, and died 1972 in Box Hill, Melbourne. She married (1) SYDNEY HAYWOOD SMITH. She married (2) WALLACE HOUGH 1933 in Victoria, Australia. He was born 1906 in Clifton Hill, and died 1967 in 'Blac', Victoria, Australia.

Child of JESSIE STAGGARD and SYDNEY SMITH is:

- i. KENNETH HAYWOOD⁶ SMITH, b. Abt. 1943; d. 1958.

Child of JESSIE STAGGARD and WALLACE HOUGH is:

- ii. GRAEME MAXWELL⁶ HOUGH, b. Abt. 1934; d. 1982.

37. PHOEBIE CLORINDA⁵ STAGGARD (*WALTER LESLIE THOMAS⁴, ROBERT SYDNEY WALTER³, THOMAS², GEORGE¹*) was born 1915 in Hawthorn, and died 1943 in Heidelberg, Melbourne. She married ? WALSH.

Children of PHOEBIE STAGGARD and ? WALSH are:

- i. LEONE⁶ WALSH.
- ii. LINDSAY WALSH.
- iii. MICHAEL WALSH.

38. DAVID⁵ STAGGARD (*WALTER LESLIE THOMAS⁴, ROBERT SYDNEY WALTER³, THOMAS², GEORGE¹*) He married PHYLLIS LAIDLAW. She was born 1928.

Children of DAVID STAGGARD and PHYLLIS LAIDLAW are:

- i. VIVIAN KAYE⁶ STAGGARD.
- ii. PHILIP DAVID STAGGARD.
- iii. KENNETH IAN STAGGARD.
- iv. JAY STAGGARD.

39. HERBERT EDWARD⁵ STAGGARD (*HUBERT EDWARD⁴, ROBERT SYDNEY WALTER³, THOMAS², GEORGE¹*) was born 1912 in Bealiba, Vic. Australia, and died 1965 in Heidelberg, Melbourne. He married ANNIE ?.

Children of HERBERT STAGGARD and ANNIE ? are:

- i. ARTHUR⁶ STAGGARD.
- ii. FREDERICK WILLIAM STAGGARD, b. 28 Jun 1915.

40. HANNAH JESSIE⁵ STAGGARD (*HUBERT EDWARD⁴, ROBERT SYDNEY WALTER³, THOMAS², GEORGE¹*) was born 1920 in Warrambol. She married ? HAYWOOD.

Child of HANNAH STAGGARD and ? HAYWOOD is:

- i. BRENDA⁶ HAYWOOD.

41. CECIL VERNON⁵ STAGGARD (*GEORGE CHARLES⁴, ROBERT SYDNEY WALTER³, THOMAS², GEORGE¹*) was born 08 Mar 1904 in Bairnsdale, Vic., and died 26 Jul 1979 in Nobel park, Melbourne. He married CHRISTINE MARIE O'BRIEN 1927.

Children of CECIL STAGGARD and CHRISTINE O'BRIEN are:

76. i. GRAHAM VERNON⁶ STAGGARD, b. 06 Jan 1930, Portland , Victoria; d. 1987, Dandenong, Vic.
77. ii. EDNA JOYCE STAGGARD, b. 08 Dec 1927, Portland , Victoria.
- iii. LEONARD ALFRED STAGGARD, b. 1934, Murtleford, Vic.; d. 1948, Murtleford, Vic..
- iv. GWENDALINE MARIE STAGGARD, b. 1933; d. 1937, Murtleford, Vic..

42. ROBERT ERNEST ARTHUR PASCOE⁵ STAGGARD (*GEORGE CHARLES⁴, ROBERT SYDNEY WALTER³, THOMAS², GEORGE¹*) was born 28 Mar 1907 in Numurkah, and died 04 Jul 1998 in Numurkah. He married LORNA MAY FIRMAN 25 Aug 1939 in Kalgoolie. She was born 06 Feb 1913, and died 13 Oct 1989 in Numurkah.

Children of ROBERT STAGGARD and LORNA FIRMAN are:

- 78. i. ROBERT JOHN⁶ STAGGARD, b. 16 Sep 1940.
- 79. ii. MAXWELL FRANCIS STAGGARD, b. 08 Jan 1945.
- 80. iii. DAVID GEORGE STAGGARD, b. 20 Jan 1946.
- 81. iv. DONALD RAY STAGGARD, b. 30 Jan 1950.

43. MARIE IRENE LOUISA⁵ STAGGARD (*GEORGE CHARLES⁴, ROBERT SYDNEY WALTER³, THOMAS², GEORGE¹*) was born 30 Apr 1909 in Shepparton, and died 13 Sep 1999 in Burwood, Melbourne. She married REGINALD MANNING.

Child of MARIE STAGGARD and REGINALD MANNING is:

- 82. i. NOEL⁶ MANNING.

44. ELLIS GEORGE (SPIKE)⁵ STAGGARD (*GEORGE CHARLES⁴, ROBERT SYDNEY WALTER³, THOMAS², GEORGE¹*) was born 04 Jul 1911 in Numurkah, and died 05 May 1984 in Heidelberg Repat Hospital. He married (1) GERTRUDE LESLIE DUNN. She died 17 Nov 1998. He married (2) WINNIFRED O'BEIRNE 12 Apr 1933 in Shepparton, daughter of JOHN O'BEIRNE and ELLEN LEAHY. She was born 02 Sep 1912 in Yarrawanga, and died 11 Mar 1969 in Mordialloc.

Children of ELLIS STAGGARD and WINNIFRED O'BEIRNE are:

- 83. i. RAYMOND⁶ STAGGARD, b. 06 Mar 1937; d. 29 Jun 1995.
- 84. ii. NANCY STAGGARD, b. 1939.
- 85. iii. RONALD ELLIS CHARLES STAGGARD, b. 02 Oct 1934.
- 86. iv. LESLIE JOHN STAGGARD, b. 17 Feb 1935.
- 87. v. MARY STAGGARD, b. 30 Mar 1941.

45. ALLAN LINDSAY⁵ STAGGARD (*GEORGE CHARLES⁴, ROBERT SYDNEY WALTER³, THOMAS², GEORGE¹*) was born 15 Jun 1913 in Numurkah. He married AGNES DUNBABBIN 24 Nov 1942 in Melbourne. She was born 11 May 1920 in Numurkah, and died 18 Apr 2002 in Mooropna, Vic., Australia.

Children of ALLAN STAGGARD and AGNES DUNBABBIN are:

- 88. i. REGINALD NORMAN⁶ STAGGARD, b. 05 Aug 1948.
- 89. ii. COLIN JAMES STAGGARD, b. 09 Jun 1947.
- 90. iii. CLIFFORD GEORGE STAGGARD, b. 28 Sep 1943.
- 91. iv. PETER LINDSAY STAGGARD, b. 16 Mar 1946.
- v. WALTER STANLEY STAGGARD, b. 06 Dec 1951; d. 29 Dec 1951.
- 92. vi. MARGERY STAGGARD, b. 05 May 1950.

46. HANNAH KRITHIA JEAN⁵ STAGGARD (*GEORGE CHARLES⁴, ROBERT SYDNEY WALTER³, THOMAS², GEORGE¹*) was born 08 Sep 1915 in Numurkah. She married PETER ERROL MACFARLANE 16 Apr 1938. He was born 29 Mar 1908 in Errol, Scotland, and died 20 May 2000 in 51 Liston St, Glen Iris, Melbourne.

Children of HANNAH STAGGARD and PETER MACFARLANE are:

- i. IAN KENNETH⁶ MACFARLANE, b. 14 Aug 1939, Cobram, Vic., Australia.
- 93. ii. LINDSAY MACFARLANE, b. 21 Mar 1941, Cobram, Vic., Australia.
- iii. PETER ERROL MACFARLANE, b. 10 Jan 1948.
- iv. JAMES (JIM) DOUGLAS MACFARLANE, b. 06 May 1953, Errol, Scotland; m. ANITA HAVERON, 02 Apr 1983, Melbourne.
- 94. v. JOY MACFARLANE, b. 05 Jan 1956.

47. ALFRED JOHN (BUCKLE)⁵ STAGGARD (*GEORGE CHARLES⁴, ROBERT SYDNEY WALTER³, THOMAS², GEORGE¹*) was born 19 Feb 1918 in Numurkah, and died 18 Jun 1972 in Echuca, Vic., Australia. He married KATHLEEN MONICA HOOPER. She died 12 Jan 1997 in Numurkah.

Children of ALFRED STAGGARD and KATHLEEN HOOPER are:

95. i. DESMOND⁶ STAGGARD.
- ii. ROBIN STAGGARD.

48. MARJORIE⁵ STAGGARD (*CHARLES JOHN⁴, JOHN THOMAS³, THOMAS², GEORGE¹*) was born 1913, and died 1961. She married (1) ROY TREMAYNE HUNT. She married (2) HOWARD RAE. She married (3) STEVEN DALTON.

Child of MARJORIE STAGGARD and ROY HUNT is:

96. i. DOYNE TREMAYNE⁶ HUNT, b. 10 Feb 1934.

49. JOYCE MURIEL⁵ STAGGARD (*CHARLES JOHN⁴, JOHN THOMAS³, THOMAS², GEORGE¹*) was born 23 Aug 1919, and died 15 Jan 1992 in Launceston. She married ALLEN LEONARD HARLEY. He was born 1917.

Children of JOYCE STAGGARD and ALLEN HARLEY are:

97. i. PETER LEONARD⁶ HARLEY, b. 14 Dec 1948.
98. ii. DAVID KIM HARLEY, b. 30 Mar 1950.

50. DON WHILEY⁵ STAGGARD (*CHARLES JOHN⁴, JOHN THOMAS³, THOMAS², GEORGE¹*) was born 01 Mar 1932. He married VALMA JEAN HENNESSEY 22 Nov 1958 in Launceston. She was born 26 Dec 1935 in Penguin.

Children of DON STAGGARD and VALMA HENNESSEY are:

99. i. BRETT JOHN⁶ STAGGARD, b. 07 Mar 1961.
- ii. YVETTE STAGGARD, b. 29 Jun 1966; m. GREIGE SULZBURGER.

51. GWENDOLINE IRIS (GWEN)⁵ STAGGARD (*CHARLES JOHN⁴, JOHN THOMAS³, THOMAS², GEORGE¹*) was born 15 Sep 1920, and died 17 Nov 1985 in Launceston. She married VERNON CHARLES HARVEY. He was born 1922, and died 22 Dec 1989.

Children of GWENDOLINE STAGGARD and VERNON HARVEY are:

- i. RUSSELL⁶ HARVEY.
- ii. JILL HARVEY, m. PAUL TAYLOR.

52. JOHN ARTHUR⁵ STAGGARD (*ARTHUR JAMES⁴, JOHN THOMAS³, THOMAS², GEORGE¹*) was born 21 Feb 1913, and died 1973 in Melbourne. He married EDNA PETERSON.

Child of JOHN STAGGARD and EDNA PETERSON is:

- i. MARGARET⁶ STAGGARD.

53. EDNA MAY⁵ STAGGARD (*ARTHUR JAMES⁴, JOHN THOMAS³, THOMAS², GEORGE¹*) was born 12 Apr 1914. She married JOHN CUNNINGHAM.

Children of EDNA STAGGARD and JOHN CUNNINGHAM are:

- i. JOYCE⁶ CUNNINGHAM.
- ii. JOHN CUNNINGHAM.

54. ROY ARTHUR JAMES⁵ STAGGARD (*ARTHUR JAMES⁴, JOHN THOMAS³, THOMAS², GEORGE¹*) was born 04 Dec 1930. He married SYBIL CLARKE 1949.

Children of ROY STAGGARD and SYBIL CLARKE are:

100. i. ROSSLYN SYBIL⁶ STAGGARD, b. 02 Jul 1950.
101. ii. CHERLY ANN STAGGARD, b. 19 Oct 1952.
102. iii. RODNEY ARTHUR JOHN STAGGARD, b. 10 Oct 1955.
- iv. MICHELLE MAE STAGGARD, b. 31 May 1958.
- v. MARK RODNEY STAGGARD, b. 08 Oct 1961.
- vi. KYLE GEORGE STAGGARD, b. 01 Jun 1966.
- vii. LEANNE JOY STAGGARD, b. 22 Mar 1970.

55. GEOFFREY ROBERT⁵ STAGGARD (*ALFRED HENRY ADOLPHUS*⁴, *GEORGE*³, *THOMAS*², *GEORGE*¹) was born 28 Apr 1910 in Launceston, Tasmania, and died 08 Sep 1992 in Devonport Tasmania. He married (1) FLORENCE KERBY 09 Mar 1934 in Launceston, daughter of ARTHUR KERBY and DAISY RELF. She was born 1913 in England, and died 29 Sep 1938 in Launceston, Tasmania. He married (2) NANCY JOAN SHERRIFF 18 May 1943 in Deloraine Baptist Manse. She was born 24 Aug 1921 in Mersy Lea, and died 15 Jan 1994 in Devonport, Tasmania.

Children of GEOFFREY STAGGARD and FLORENCE KERBY are:

- i. THELMA JEAN⁶ STAGGARD, b. 01 Nov 1935.
- ii. RHONDA ELVIE STAGGARD, b. 07 Mar 1937, Deloraine; d. 20 Oct 1964, Barking, Essex.
- iii. BRYAN STAGGARD, b. 21 May 1938.

Children of GEOFFREY STAGGARD and NANCY SHERRIFF are:

- iv. HAYDN GEOFFREY⁶ STAGGARD, b. 19 Dec 1943.
- v. ELAINE MARJORIE STAGGARD, b. 04 Jun 1946.
- vi. VINCENT THOMAS STAGGARD, b. 02 Dec 1954, Hobart; m. (1) CHRISTINE ELMA DEGUERON MISS; b. 19 Aug 1949, Willoughby, NSW; m. (2) JOY MARION BATCHELOR; b. 27 May 1955, Hobart; m. (3) VICKI FYSH.

56. RHODA ELVIE⁵ STAGGARD (*ALFRED HENRY ADOLPHUS*⁴, *GEORGE*³, *THOMAS*², *GEORGE*¹) was born 05 Nov 1912, and died 05 Jul 1994. She married KENNETH JOHN CORKERY. He was born 1905, and died 28 Apr 1958.

Children of RHODA STAGGARD and KENNETH CORKERY are:

- i. IRIS⁶ CORKERY, b. 15 Apr 1937; m. LEO MILLS.
- ii. NOLA CORKERY, b. 28 Feb 1938.
- iii. GERALD CORKERY, b. 03 Aug 1944.
- iv. DARREL CORKERY, b. 29 Jun 1948.

57. CLEM VERDUN⁵ STAGGARD (*ALFRED HENRY ADOLPHUS*⁴, *GEORGE*³, *THOMAS*², *GEORGE*¹) was born 18 Sep 1916 in Campbell Town. He married (1) CARMEL THRESE FARRAH GORMAN, daughter of THOMAS GORMAN and ELSIE RUTLEDGE. She was born 24 Oct 1921 in Melbourne. He married (2) JEAN PEACE BROWN Nov 1939. She was born 1917 in Deloraine, and died 19 Oct 1971 in Launceston, Tasmania.

Children of CLEM STAGGARD and JEAN BROWN are:

- i. MAXWELL BROWN⁶ STAGGARD.
- ii. BARRY JOHN STAGGARD, b. 07 Feb 1940.

Generation No. 6

58. IAN LISTER⁶ HANDRICKS (*EDWIN (EDDIE) LISTER*⁵, *RUBY FRANCES*⁴ STAGGARD, *ARTHUR*³, *THOMAS*², *GEORGE*¹) was born 06 Jul 1955 in At Home, 9 Farringdon St, Glen Innes, Auckland. He married JOCELYN RUTH BROWN 11 Feb 1978 in Holy Trinity Anglican Church, Dargaville, daughter of OWEN BROWN and ROMA SIMONS. She was born 16 Dec 1954 in Te Kopuru.

Children of IAN HANDRICKS and JOCELYN BROWN are:

- i. DANIEL LOGAN⁷ HANDRICKS, b. 20 May 1981, National Women's Hospital, Auckland; d. 08 May 2017, 40 Grant Ave, Hope Island, Gold Coast, Queensland, Australia.
- ii. HELEN RUBY HANDRICKS, b. 31 Oct 1983, John Radcliffe Hospital, Oxford, England; m. RICHARD GLEW, 03 Jan 2020, Australia.
- iii. ÉLOÏSE ADÈLE HANDRICKS, b. 11 Oct 1985, John Radcliffe Hospital, Oxford, England; m. ANTON GILBERT, 03 Oct 2020, Brisbane, Australia.

59. LYNETTE MARGARET⁶ HANDRICKS (*EDWIN (EDDIE) LISTER*⁵, *RUBY FRANCES*⁴ STAGGARD, *ARTHUR*³, *THOMAS*², *GEORGE*¹) was born 02 Jul 1957 in At Home, 9 Farringdon St, Glen Innes, Auckland. She married SIANG HUAT OOI 25 Mar 1978 in Auckland, son of HOI OOI and SAW PHAN. He was born 30 Nov 1952 in Malaysia.

Children of LYNETTE HANDRICKS and SIANG OOI are:

- i. LISA MARGARET⁷ OOI, b. 20 Oct 1981.
103. ii. FIONA MAY OOI, b. 22 Mar 1984, Auckland.
- iii. ROBYN JANE OOI, b. 31 Dec 1987.

60. GLENN PETER⁶ HANDRICKS (*EDWIN (EDDIE) LISTER⁵, RUBY FRANCES⁴ STAGGARD, ARTHUR³, THOMAS², GEORGE¹*) was born 03 Mar 1966 in Middlemore Hospital, Auckland. He married (1) JUNE ELIZABETH DAVISON 12 Sep 1987 in Auckland, daughter of ROY BRINK and MARJORIE PAPE. She was born 06 Mar 1966 in Australia. He married (2) FAY LUCINDA WILKINSON 13 Jul 2019 in Sandy Creek, Queensland, daughter of ROBERT WILKINSON and LEILA SANDERS. She was born 04 Mar 1965 in Horsham, Victoria.

Children of GLENN HANDRICKS and JUNE DAVISON are:

- i. KIMBERLEY MARIE⁷ HANDRICKS, b. 15 Jul 1995, Auckland.
- ii. KELLIE JUNE HANDRICKS, b. 15 Mar 1998, Auckland.

61. LINDA MAY⁶ HANDRICKS (*ROBERT HARRY⁵, RUBY FRANCES⁴ STAGGARD, ARTHUR³, THOMAS², GEORGE¹*) was born 11 Sep 1962. She married RAYMOND JOHN MCLEAN 16 Sep 1987. He was born 12 Sep 1962.

Children of LINDA HANDRICKS and RAYMOND MCLEAN are:

- i. CHARLOTTE (CHARLIE) MAY⁷ MCLEAN, b. 15 Mar 1987.
- ii. MAX CHRISTIAN MCLEAN, b. 08 Sep 1988.

62. PAUL⁶ HANDRICKS (*NORMAN LESLIE⁵, RUBY FRANCES⁴ STAGGARD, ARTHUR³, THOMAS², GEORGE¹*) was born 23 Mar 1944 in Masterton. He married VICKI ASHTON CHATFIELD 11 Jan 1966 in Gisborne, daughter of KEITH CHATFIELD and PIKI MORRELL. She was born 12 Jun 1948 in Opotiki.

Children of PAUL HANDRICKS and VICKI CHATFIELD are:

104. i. PAUL KEITH NORMAN⁷ HANDRICKS, b. 18 Aug 1967, Opotiki.
105. ii. LISA-JANE HANDRICKS, b. 26 Jul 1969, Opotiki.
- iii. LEIGH-ANNE HANDRICKS, b. 20 Jul 1966, Opotiki.
106. iv. JOANNE ASHTON HANDRICKS, b. 27 Jun 1970, Gisborne.

63. YVONNE IRENE⁶ HANDRICKS (*DOUGLAS HUBERT NELSON⁵, RUBY FRANCES⁴ STAGGARD, ARTHUR³, THOMAS², GEORGE¹*) was born 29 Dec 1940 in Auckland. She married (1) ROBERT NORMAN FOGAL Abt. 1957 in Akron New York, son of GEORGE FOGAL and FLORENCE STIBBS. He was born 19 Oct 1931 in on the family farm, Akron, New York. She married (2) LEON FOSTER ROWIN 26 Feb 1966 in Los Angeles, son of ROLLIE ROWIN and ETHEL VAN DUZEE. He was born 19 Aug 1938.

Children of YVONNE HANDRICKS and ROBERT FOGAL are:

- i. WADE EDWARD⁷ FOGAL, b. 22 Sep 1957, California.
107. ii. VICTORIA LYNNE FOGAL, b. 04 Oct 1958, California.
108. iii. RAYMIE PAUL FOGAL, b. 04 Apr 1961, Hawthorne, Ca.

Child of YVONNE HANDRICKS and LEON ROWIN is:

109. iv. STEVEN LEE⁷ ROWIN, b. 09 Oct 1966, California.

64. JENNIFER MARY⁶ STAGGARD (*FREDERICK GEORGE⁵, ERNEST FREDERICK ARTHUR⁴, ROBERT SYDNEY WALTER³, THOMAS², GEORGE¹*) was born 18 May 1934. She married DONALD MCPHEE SHARP. He was born 12 Apr 1933.

Children of JENNIFER STAGGARD and DONALD SHARP are:

- i. PETER DAVID⁷ SHARP, b. 27 Dec 1964.
- ii. ROBERT JAMES SHARP, b. 15 Aug 1965.
- iii. KATHLEEN LOUSIE SHARP, b. 18 Jan 1968.
- iv. MEGAN ELIZABETH SHARP, b. 18 Jan 1968.
- v. GRAEME MCPHEE SHARP, b. 27 Jan 1972.

65. JOHN FREDERICK⁶ STAGGARD (*FREDERICK GEORGE⁵, ERNEST FREDERICK ARTHUR⁴, ROBERT SYDNEY WALTER³, THOMAS², GEORGE¹*) was born 13 Mar 1941. He married JUNE LESLEY FORREST. She was born 20 Oct 1944.

Children of JOHN STAGGARD and JUNE FORREST are:

- i. SUSAN MAREE⁷ STAGGARD, b. 11 Apr 1969.
- ii. LEONIE JUNE STAGGARD, b. 17 Sep 1972.
- iii. NATALIE RAE STAGGARD, b. 22 Oct 1974.

66. GLYNN THOMAS EWARD⁶ STAGGARD (*THOMAS JOHN⁵, ERNEST FREDERICK ARTHUR⁴, ROBERT SYDNEY WALTER³, THOMAS², GEORGE¹*) was born 16 Sep 1944. He married SUSANNE DORIS NISBET. She was born 07 Sep 1948.

Children of GLYNN STAGGARD and SUSANNE NISBET are:

- i. KYLIE LEANNE⁷ STAGGARD, b. 02 Jul 1970.
- ii. CAMERON GLYNN STAGGARD, b. 11 Aug 1972.

67. VICTOR⁶ STAGGARD (*WALTER LOUIS (WALT)⁵, ERNEST FREDERICK ARTHUR⁴, ROBERT SYDNEY WALTER³, THOMAS², GEORGE¹*) was born 02 Jul 1942. He married LIZ WHITE. She was born 02 Mar 1950.

Children of VICTOR STAGGARD and LIZ WHITE are:

- i. SHAUN ANDREW⁷ STAGGARD, b. 08 Sep 1969.
- ii. ANDREA LYNN STAGGARD, b. 19 Nov 1970.

68. IAN⁶ STAGGARD (*WALTER LOUIS (WALT)⁵, ERNEST FREDERICK ARTHUR⁴, ROBERT SYDNEY WALTER³, THOMAS², GEORGE¹*) was born 05 Mar 1944. He married KAYE REYNOLDS. She was born 03 Jan 1947.

Children of IAN STAGGARD and KAYE REYNOLDS are:

- i. KELLIE⁷ STAGGARD, b. 28 May 1970.
- ii. BRENTON STAGGARD, b. 22 Sep 1972.
- iii. RYAN STAGGARD, b. 24 Jun 1974.
- iv. LEIGHTON STAGGARD, b. 21 Apr 1977.

69. MARGARET ANN⁶ STAGGARD (*WALTER LOUIS (WALT)⁵, ERNEST FREDERICK ARTHUR⁴, ROBERT SYDNEY WALTER³, THOMAS², GEORGE¹*) was born 21 Oct 1947. She married ROBERT GEORGE FINCH. He was born 10 Jul 1944.

Child of MARGARET STAGGARD and ROBERT FINCH is:

- i. DANIEL⁷ FINCH, b. 31 Jul 1978.

70. KATHLEEN LYNETTE⁶ HOOPER (*MYRTLE ADEL⁵ STAGGARD, ERNEST FREDERICK ARTHUR⁴, ROBERT SYDNEY WALTER³, THOMAS², GEORGE¹*) was born 21 Oct 1938. She married DONALD VICOR ORD. He was born 06 Sep 1937.

Children of KATHLEEN HOOPER and DONALD ORD are:

- i. MARK ANDREW⁷ ORD, b. 26 Jul 1961.
- ii. JANE KATHLEEN ORD, b. 31 Dec 1962.
- iii. LISA ANNE ORD, b. 02 Aug 1964.
- iv. PETER ANDREW ORD, b. 24 Mar 1966.
- v. RUTH ADELE ORD, b. 13 Nov 1967.

71. MALCOLM ROSS⁶ HOOPER (*MYRTLE ADEL⁵ STAGGARD, ERNEST FREDERICK ARTHUR⁴, ROBERT SYDNEY WALTER³, THOMAS², GEORGE¹*) was born 13 May 1940. He married DIANNE MARY HUMPHRIS. She was born 05 May 1947.

Children of MALCOLM HOOPER and DIANNE HUMPHRIS are:

- i. JUSTIN PAUL⁷ HOOPER, b. 17 Sep 1972.
- ii. RYAN MALCOLM HOOPER, b. 18 Jul 1974.
- iii. SHAN TARA HOOPER, b. 11 Jan 1977.

72. NOEL LESLIE JOSEPH⁶ HOOPER (*MYRTLE ADEL⁵ STAGGARD, ERNEST FREDERICK ARTHUR⁴, ROBERT SYDNEY WALTER³, THOMAS², GEORGE¹*) was born 01 Dec 1941. He married LILLIAN MERECIECA. She was born 15 Mar 1947.

Children of NOEL HOOPER and LILLIAN MERECIECA are:

- i. GRANT⁷ HOOPER, b. 29 May 1975.
- ii. LAUREN HOOPER, b. 24 Apr 1983.

73. GARRY MAXWELL⁶ HOOPER (*MYRTLE ADEL⁵ STAGGARD, ERNEST FREDERICK ARTHUR⁴, ROBERT SYDNEY WALTER³, THOMAS², GEORGE¹*) was born 30 Mar 1945. He married PHYLLIS PEACE.

Children of GARRY HOOPER and PHYLLIS PEACE are:

- i. LINDA⁷ HOOPER, b. 09 Jan 1966.
- ii. SUSAN HOOPER, b. 12 Jul 1967.
- iii. DEBRA HOOPER, b. 10 Sep 1971.
- iv. WENDY HOOPER, b. 10 Feb 1973.

74. ALAN⁶ WHITTEN (*KATHLEEN ALICE⁵ STAGGARD, ERNEST FREDERICK ARTHUR⁴, ROBERT SYDNEY WALTER³, THOMAS², GEORGE¹*) was born 09 Jan 1943. He married (1) JOAN DREW. He married (2) PAMELA HOPE. She was born 09 Feb 1945.

Children of ALAN WHITTEN and JOAN DREW are:

- i. GARETH ALAN⁷ WHITTEN, b. 10 Sep 1967.
- ii. NAOMI JANE WHITTEN, b. 16 Nov 1969.
- iii. NERRIDA LOUISE WHITTEN, b. 10 Aug 1971.

75. ROBIN⁶ WHITTEN (*KATHLEEN ALICE⁵ STAGGARD, ERNEST FREDERICK ARTHUR⁴, ROBERT SYDNEY WALTER³, THOMAS², GEORGE¹*) was born 17 Sep 1949. He married HEATHER JOY PROSSER.

Children of ROBIN WHITTEN and HEATHER PROSSER are:

- i. KIRSTY LYN⁷ WHITTEN, b. 07 Jul 1974.
- ii. LEIGH DAVID WHITTEN, b. 11 Jul 1975.

76. GRAHAM VERNON⁶ STAGGARD (*CECIL VERNON⁵, GEORGE CHARLES⁴, ROBERT SYDNEY WALTER³, THOMAS², GEORGE¹*) was born 06 Jan 1930 in Portland , Victoria, and died 1987 in Dandenong, Vic. He married JOAN MARY DONNELLY 1959.

Children of GRAHAM STAGGARD and JOAN DONNELLY are:

- i. GAVIN⁷ STAGGARD.
- ii. KAYLENE STAGGARD.
- iii. PAUL STAGGARD.

77. EDNA JOYCE⁶ STAGGARD (*CECIL VERNON⁵, GEORGE CHARLES⁴, ROBERT SYDNEY WALTER³, THOMAS², GEORGE¹*) was born 08 Dec 1927 in Portland , Victoria. She married ARTHUR JOHN HART. He was born 13 Nov 1929 in Dover, Kent,UK.

Child of EDNA STAGGARD and ARTHUR HART is:

- i. PETER JOHN⁷ HART, b. 1961.

78. ROBERT JOHN⁶ STAGGARD (*ROBERT ERNEST ARTHUR PASCOE⁵, GEORGE CHARLES⁴, ROBERT SYDNEY WALTER³, THOMAS², GEORGE¹*) was born 16 Sep 1940. He married MARGARET CORRIE May 1969.

Child of ROBERT STAGGARD and MARGARET CORRIE is:

- i. VALERIE⁷ STAGGARD, b. 26 Jan 1970.

79. MAXWELL FRANCIS⁶ STAGGARD (*ROBERT ERNEST ARTHUR PASCOE*⁵, *GEORGE CHARLES*⁴, *ROBERT SYDNEY WALTER*³, *THOMAS*², *GEORGE*¹) was born 08 Jan 1945. He married DAWN LORRAINE COOKNELL 25 Feb 1967 in Warrnambool.

Children of MAXWELL STAGGARD and DAWN COOKNELL are:

110. i. BARRY MAXWELL⁷ STAGGARD, b. 29 Sep 1967.
- ii. JACINTA LEE STAGGARD, b. 06 Mar 1969.
111. iii. INGRID DAWN STAGGARD, b. 11 May 1975.

80. DAVID GEORGE⁶ STAGGARD (*ROBERT ERNEST ARTHUR PASCOE*⁵, *GEORGE CHARLES*⁴, *ROBERT SYDNEY WALTER*³, *THOMAS*², *GEORGE*¹) was born 20 Jan 1946. He married (1) NOLA COOKNELL Aug 1968 in Cobden. He married (2) MARJIE MEADE 16 Apr 1988 in Cobden. She was born 1956.

Children of DAVID STAGGARD and NOLA COOKNELL are:

112. i. ROHAN DAVID⁷ STAGGARD, b. 11 Nov 1968.
113. ii. LYN MAREE STAGGARD, b. 11 Mar 1970.

81. DONALD RAY⁶ STAGGARD (*ROBERT ERNEST ARTHUR PASCOE*⁵, *GEORGE CHARLES*⁴, *ROBERT SYDNEY WALTER*³, *THOMAS*², *GEORGE*¹) was born 30 Jan 1950. He married MARGARET ANNE COLLINS 22 May 1971.

Children of DONALD STAGGARD and MARGARET COLLINS are:

114. i. TRACEY MICHELLE⁷ STAGGARD, b. 16 Feb 1976.
- ii. CHRISTOPHER RAY STAGGARD, b. 08 Mar 1978.

82. NOEL⁶ MANNING (*MARIE IRENE LOUISA*⁵ STAGGARD, *GEORGE CHARLES*⁴, *ROBERT SYDNEY WALTER*³, *THOMAS*², *GEORGE*¹) He married JOY ROSEMARY SPOWART.

Children of NOEL MANNING and JOY SPOWART are:

- i. CRAIG⁷ MANNING, b. 1970.
- ii. JENELLE MANNING, b. 1972.
- iii. NATALIE MANNING, b. 1978.

83. RAYMOND⁶ STAGGARD (*ELLIS GEORGE (SPIKE)*⁵, *GEORGE CHARLES*⁴, *ROBERT SYDNEY WALTER*³, *THOMAS*², *GEORGE*¹) was born 06 Mar 1937, and died 29 Jun 1995. He married SHIRLEY HINDSON.

Children of RAYMOND STAGGARD and SHIRLEY HINDSON are:

- i. KERRY⁷ STAGGARD, m. DAREL SKEWS.
- ii. BRETT STAGGARD.
- iii. SHAREE STAGGARD.

84. NANCY⁶ STAGGARD (*ELLIS GEORGE (SPIKE)*⁵, *GEORGE CHARLES*⁴, *ROBERT SYDNEY WALTER*³, *THOMAS*², *GEORGE*¹) was born 1939. She married KEVIN PAXTON.

Children of NANCY STAGGARD and KEVIN PAXTON are:

- i. GREGORY⁷ PAXTON.
- ii. KIM PAXTON.
- iii. LISA PAXTON.

85. RONALD ELLIS CHARLES⁶ STAGGARD (*ELLIS GEORGE (SPIKE)*⁵, *GEORGE CHARLES*⁴, *ROBERT SYDNEY WALTER*³, *THOMAS*², *GEORGE*¹) was born 02 Oct 1934. He married CHRISTINA O'BRIEN.

Children of RONALD STAGGARD and CHRISTINA O'BRIEN are:

- i. JANELLE⁷ STAGGARD, b. 1968.
- ii. NICHOLE STAGGARD, b. 1974.

86. LESLIE JOHN⁶ STAGGARD (*ELLIS GEORGE (SPIKE)⁵, GEORGE CHARLES⁴, ROBERT SYDNEY WALTER³, THOMAS², GEORGE¹*) was born 17 Feb 1935. He married ELIZABETH MOORE.

Children of LESLIE STAGGARD and ELIZABETH MOORE are:

- i. DEBRA⁷ STAGGARD, b. 1963; m. ALLEN COOPER.
- ii. WENDY STAGGARD, b. 1965.
- iii. DAREL STAGGARD, b. 1968.

87. MARY⁶ STAGGARD (*ELLIS GEORGE (SPIKE)⁵, GEORGE CHARLES⁴, ROBERT SYDNEY WALTER³, THOMAS², GEORGE¹*) was born 30 Mar 1941. She married JIM ROGERSON.

Children of MARY STAGGARD and JIM ROGERSON are:

- i. DONNA⁷ ROGERSON.
- ii. PAUL ROGERSON.
- iii. MARNIE ROGERSON.

88. REGINALD NORMAN⁶ STAGGARD (*ALLAN LINDSAY⁵, GEORGE CHARLES⁴, ROBERT SYDNEY WALTER³, THOMAS², GEORGE¹*) was born 05 Aug 1948. He married HEATHER ROSS.

Child of REGINALD STAGGARD and HEATHER ROSS is:

- i. RODNEY ALLAN⁷ STAGGARD, b. 1975.

89. COLIN JAMES⁶ STAGGARD (*ALLAN LINDSAY⁵, GEORGE CHARLES⁴, ROBERT SYDNEY WALTER³, THOMAS², GEORGE¹*) was born 09 Jun 1947. He married SHARON PASCOE.

Children of COLIN STAGGARD and SHARON PASCOE are:

- i. JASON⁷ STAGGARD, b. 1971.
- ii. KIM STAGGARD, b. 1972.
- iii. ROGER STAGGARD, b. 1973.

90. CLIFFORD GEORGE⁶ STAGGARD (*ALLAN LINDSAY⁵, GEORGE CHARLES⁴, ROBERT SYDNEY WALTER³, THOMAS², GEORGE¹*) was born 28 Sep 1943. He married JENNIFER DUDLEY.

Children of CLIFFORD STAGGARD and JENNIFER DUDLEY are:

115. i. DARREN PAUL⁷ STAGGARD, b. 1967.
- ii. CRAIG STAGGARD, b. 1968.
- iii. LEANNE MARGERIE STAGGARD, b. 1969.

91. PETER LINDSAY⁶ STAGGARD (*ALLAN LINDSAY⁵, GEORGE CHARLES⁴, ROBERT SYDNEY WALTER³, THOMAS², GEORGE¹*) was born 16 Mar 1946. He married RHONDA SCARBOROUGH.

Children of PETER STAGGARD and RHONDA SCARBOROUGH are:

- i. GLENN DEAN⁷ STAGGARD, b. 1969.
- ii. KAREN MICHELLE STAGGARD, b. 1970.
- iii. LISA MAREE STAGGARD, b. 1971.

92. MARGERIE⁶ STAGGARD (*ALLAN LINDSAY⁵, GEORGE CHARLES⁴, ROBERT SYDNEY WALTER³, THOMAS², GEORGE¹*) was born 05 May 1950. She married FRANK MUTSAYERS.

Child of MARGERIE STAGGARD and FRANK MUTSAYERS is:

- i. SHAWN⁷ MUTSAYERS.

93. PETER ERROL⁶ MACFARLANE (*HANNAH KRITHIA JEAN⁵ STAGGARD, GEORGE CHARLES⁴, ROBERT SYDNEY WALTER³, THOMAS², GEORGE¹*) was born 10 Jan 1948. He married DIANNE ISAACS. She was born 08 Jun 1955.

Children of PETER MACFARLANE and DIANNE ISAACS are:

- i. LEIGH⁷ MACFARLANE, b. 15 Mar 1982.
- ii. LACHLAN MACFARLANE, b. 01 Dec 1983.
- iii. BRYSON MACFARLANE, b. 22 Apr 1990.

94. JOY⁶ MACFARLANE (*HANNAH KRITHIA JEAN⁵ STAGGARD, GEORGE CHARLES⁴, ROBERT SYDNEY WALTER³, THOMAS², GEORGE¹*) was born 05 Jan 1956. She married WAYNE PATERSON. He was born 1957.

Children of JOY MACFARLANE and WAYNE PATERSON are:

- i. LUKE⁷ PATERSON, b. 13 Jul 1981.
- ii. ALANA PATERSON, b. 08 Mar 1985.
- iii. DOUGLAS PATERSON, b. 29 May 1987.

95. DESMOND⁶ STAGGARD (*ALFRED JOHN (BUCKLE)⁵, GEORGE CHARLES⁴, ROBERT SYDNEY WALTER³, THOMAS², GEORGE¹*) He married JUDY ?.

Child of DESMOND STAGGARD and JUDY ? is:

- i. TINA⁷ STAGGARD.

96. DOYNE TREMAYNE⁶ HUNT (*MARJORIE⁵ STAGGARD, CHARLES JOHN⁴, JOHN THOMAS³, THOMAS², GEORGE¹*) was born 10 Feb 1934. He married BEATRICE ?.

Children of DOYNE HUNT and BEATRICE ? are:

- i. AMELIA⁷ HUNT, m. TIM JOHNSTONE.
- ii. GUY HUNT.
- iii. EMMA HUNT.
- iv. SALLY BEA HUNT.

97. PETER LEONARD⁶ HARLEY (*JOYCE MURIEL⁵ STAGGARD, CHARLES JOHN⁴, JOHN THOMAS³, THOMAS², GEORGE¹*) was born 14 Dec 1948. He married PETAH WATSON 13 Jul 1973.

Children of PETER HARLEY and PETAH WATSON are:

- i. NICOLE LOUISE⁷ HARLEY, b. 14 Dec 1974.
- ii. FIONA ELIZABETH HARLEY, b. 28 Sep 1976.

98. DAVID KIM⁶ HARLEY (*JOYCE MURIEL⁵ STAGGARD, CHARLES JOHN⁴, JOHN THOMAS³, THOMAS², GEORGE¹*) was born 30 Mar 1950. He married MAXINE JOYCE SUTCLIFFE 02 Feb 1973.

Children of DAVID HARLEY and MAXINE SUTCLIFFE are:

- i. MATTHEW⁷ HARLEY, b. 1982.
- ii. SARAH JANE HARLEY.
- iii. DAVID HARLEY.

99. BRETT JOHN⁶ STAGGARD (*DON WHILEY⁵, CHARLES JOHN⁴, JOHN THOMAS³, THOMAS², GEORGE¹*) was born 07 Mar 1961. He married CARMEL SIMONE BULLOCK.

Child of BRETT STAGGARD and CARMEL BULLOCK is:

- i. CARMEL MAREE⁷ STAGGARD.

100. ROSSLYN SYBIL⁶ STAGGARD (*ROY ARTHUR JAMES⁵, ARTHUR JAMES⁴, JOHN THOMAS³, THOMAS², GEORGE¹*) was born 02 Jul 1950. She married RICHARD FIGG 18 Dec 1972.

Child of ROSSLYN STAGGARD and RICHARD FIGG is:

- i. ANDREW MARK⁷ FIGG, b. 1975.

101. CHERLY ANN⁶ STAGGARD (*ROY ARTHUR JAMES⁵, ARTHUR JAMES⁴, JOHN THOMAS³, THOMAS², GEORGE¹*) was born 19 Oct 1952. She married KENNETH PHILLIS.

Children of CHERLY STAGGARD and KENNETH PHILLIS are:

- i. DANIEL ROY⁷ PHILLIS, b. 31 Oct 1977.
- ii. WAYNE MATTHEW PHILLIS, b. 16 Nov 1979.

102. RODNEY ARTHUR JOHN⁶ STAGGARD (*ROY ARTHUR JAMES⁵, ARTHUR JAMES⁴, JOHN THOMAS³, THOMAS², GEORGE¹*) was born 10 Oct 1955. He married (1) SUE HEWITT. He married (2) ROBYN BURTON.

Child of RODNEY STAGGARD and ROBYN BURTON is:

- i. SYBIL ROSE⁷ STAGGARD, b. 05 Aug 1992.

Generation No. 7

103. FIONA MAY⁷ OOI (*LYNETTE MARGARET⁶ HANDRICKS, EDWIN (EDDIE) LISTER⁵, RUBY FRANCES⁴ STAGGARD, ARTHUR³, THOMAS², GEORGE¹*) was born 22 Mar 1984 in Auckland. She married ANTONIO MASTELLONE 19 Oct 2014 in Massa Lubrense, Italy.

Child of FIONA OOI and ANTONIO MASTELLONE is:

- i. SILVANA⁸ MASTELLONE, b. 05 Jan 2016, Italy.

104. PAUL KEITH NORMAN⁷ HANDRICKS (*PAUL⁶, NORMAN LESLIE⁵, RUBY FRANCES⁴ STAGGARD, ARTHUR³, THOMAS², GEORGE¹*) was born 18 Aug 1967 in Opotiki. He married (1) KAREN GALLY. He married (2) LINDA REECE, daughter of DAVID REECE and NORMA GOODSPEED. He married (3) OLIVIA BAYLISS.

Children of PAUL HANDRICKS and KAREN GALLY are:

- i. BENJAMIN⁸ HANDRICKS, b. 01 Jan 1992.
- ii. KELVIN HANDRICKS, b. 02 Apr 1993.

Child of PAUL HANDRICKS and LINDA REECE is:

- iii. DEVON NORMAN⁸ REECE, b. 17 Sep 1999.

Children of PAUL HANDRICKS and OLIVIA BAYLISS are:

- iv. LEVI JOSEF⁸ BAYLISS-HANDRICKS, b. 08 Jan 2020, Wellington.
- v. HAZEL BAYLISS-HANDRICKS, b. Aug 2021, Raumati.

105. LISA-JANE⁷ HANDRICKS (*PAUL⁶, NORMAN LESLIE⁵, RUBY FRANCES⁴ STAGGARD, ARTHUR³, THOMAS², GEORGE¹*) was born 26 Jul 1969 in Opotiki. She met CARL PHILPOTT. He was born 13 Jul 1972 in Auckland.

Children of LISA-JANE HANDRICKS and CARL PHILPOTT are:

- i. FLETCHER NORMAN⁸ PHILPOTT, b. 14 Feb 2004, Whakatane.
- ii. SPENCER HENRI PHILPOTT, b. 23 Sep 2005, Whakatane.

106. JOANNE ASHTON⁷ HANDRICKS (*PAUL⁶, NORMAN LESLIE⁵, RUBY FRANCES⁴ STAGGARD, ARTHUR³, THOMAS², GEORGE¹*) was born 27 Jun 1970 in Gisborne. She married PAUL ELSOM 17 Mar 2003 in Snells Beach. He was born Nov in Auckland.

Child of JOANNE HANDRICKS and PAUL ELSOM is:

- i. TOBY ASHTON⁸ ELSOM, b. 14 Jul 2004.

107. VICTORIA LYNNE⁷ FOGAL (*YVONNE IRENE⁶ HANDRICKS, DOUGLAS HUBERT NELSON⁵, RUBY FRANCES⁴ STAGGARD, ARTHUR³, THOMAS², GEORGE¹*) was born 04 Oct 1958 in California. She married (1) STEPHEN ROCKER 1977. She married (2) RONALD PATTERSON 1987.

Child of VICTORIA FOGAL and STEPHEN ROCKER is:

116. i. SHANON⁸ ROCKER, b. 24 Aug 1977.

Children of VICTORIA FOGAL and RONALD PATTERSON are:

117. ii. JUANNE⁸ PATTERSON.
iii. KIRSTY PATTERSON, b. 1990, Torrance, CA.
iv. COURTNEY PATTERSON.

108. RAYMIE PAUL⁷ FOGAL (*YVONNE IRENE⁶ HANDRICKS, DOUGLAS HUBERT NELSON⁵, RUBY FRANCES⁴ STAGGARD, ARTHUR³, THOMAS², GEORGE¹*) was born 04 Apr 1961 in Hawthorne, Ca. He met (1) SHERYL MATTHEWS. He married (2) SHAUNA LORRAINE MCAFEE 03 Mar 1989. She was born 26 May 1966 in Red Deer, Alberta.

Child of RAYMIE FOGAL and SHERYL MATTHEWS is:

i. ROBERT BURTON⁸ FOGAL, b. 05 Jun 1987.

Child of RAYMIE FOGAL and SHAUNA MCAFEE is:

ii. RYAN TERRY⁸ FOGAL, b. 31 Dec 1998, California.

109. STEVEN LEE⁷ ROWIN (*YVONNE IRENE⁶ HANDRICKS, DOUGLAS HUBERT NELSON⁵, RUBY FRANCES⁴ STAGGARD, ARTHUR³, THOMAS², GEORGE¹*) was born 09 Oct 1966 in California.

Child of STEVEN LEE ROWIN is:

i. ASHLEE⁸ ROWIN.

110. BARRY MAXWELL⁷ STAGGARD (*MAXWELL FRANCIS⁶, ROBERT ERNEST ARTHUR PASCOE⁵, GEORGE CHARLES⁴, ROBERT SYDNEY WALTER³, THOMAS², GEORGE¹*) was born 29 Sep 1967. He met (1) PAULINE MCMINI. He married (2) KIM DYKE 17 Mar 2002.

Child of BARRY STAGGARD and PAULINE MCMINI is:

i. TOM YARRAN⁸ STAGGARD, b. 19 Apr 1995.

Child of BARRY STAGGARD and KIM DYKE is:

ii. JAI HARPER⁸ STAGGARD, b. 22 Nov 2004.

111. INGRID DAWN⁷ STAGGARD (*MAXWELL FRANCIS⁶, ROBERT ERNEST ARTHUR PASCOE⁵, GEORGE CHARLES⁴, ROBERT SYDNEY WALTER³, THOMAS², GEORGE¹*) was born 11 May 1975. She married SEAN DAVALGA RAFFERTY 19 Dec 1999.

Children of INGRID STAGGARD and SEAN RAFFERTY are:

i. HOLLIE ESTHER DAVALGA⁸ RAFFERTY, b. 20 May 2002.
ii. OSCAR FLYNN DAVALGA RAFFERTY, b. 20 Nov 2003.
iii. EVA GRETA DAVALGA RAFFERTY, b. 13 Dec 2004.

112. ROHAN DAVID⁷ STAGGARD (*DAVID GEORGE⁶, ROBERT ERNEST ARTHUR PASCOE⁵, GEORGE CHARLES⁴, ROBERT SYDNEY WALTER³, THOMAS², GEORGE¹*) was born 11 Nov 1968. He met MONICA WOOD.

Child of ROHAN STAGGARD and MONICA WOOD is:

i. JEREMY⁸ STAGGARD, b. Sep 1997.

113. LYN MAREE⁷ STAGGARD (*DAVID GEORGE⁶, ROBERT ERNEST ARTHUR PASCOE⁵, GEORGE CHARLES⁴, ROBERT SYDNEY WALTER³, THOMAS², GEORGE¹*) was born 11 Mar 1970. She married KARL PARKER Dec 1992.

Children of LYN STAGGARD and KARL PARKER are:

i. JAYDEN KARL⁸ PARKER, b. 29 Jun 1996.
ii. LIAM ROBERT PARKER, b. 17 Jun 1998.
iii. LAUREN MAY PARKER, b. 28 Nov 2000.

114. TRACEY MICHELLE⁷ STAGGARD (*DONALD RAY⁶, ROBERT ERNEST ARTHUR PASCOE⁵, GEORGE CHARLES⁴, ROBERT SYDNEY WALTER³, THOMAS², GEORGE¹*) was born 16 Feb 1976. She married BILL HAMILTON 19 Apr 1997.

Children of TRACEY STAGGARD and BILL HAMILTON are:

- i. JASMYN PAIGE⁸ HAMILTON, b. 25 Nov 1999.
- ii. HOLLY RAE HAMLTON, b. 14 Feb 2003.

115. DARREN PAUL⁷ STAGGARD (*CLIFFORD GEORGE⁶, ALLAN LINDSAY⁵, GEORGE CHARLES⁴, ROBERT SYDNEY WALTER³, THOMAS², GEORGE¹*) was born 1967. He married TERRI HOWARD.

Child of DARREN STAGGARD and TERRI HOWARD is:

- i. MICHELL TYSON⁸ STAGGARD.

Generation No. 8

116. SHANON⁸ ROCKER (*VICTORIA LYNNE⁷ FOGAL, YVONNE IRENE⁶ HANDRICKS, DOUGLAS HUBERT NELSON⁵, RUBY FRANCES⁴ STAGGARD, ARTHUR³, THOMAS², GEORGE¹*) was born 24 Aug 1977. She married TIMOTHY ?.

Child of SHANON ROCKER and TIMOTHY ? is:

- i. ?⁹ ?.

117. JUANNE⁸ PATTERSON (*VICTORIA LYNNE⁷ FOGAL, YVONNE IRENE⁶ HANDRICKS, DOUGLAS HUBERT NELSON⁵, RUBY FRANCES⁴ STAGGARD, ARTHUR³, THOMAS², GEORGE¹*) She married RICHARD MILLER.

Child of JUANNE PATTERSON and RICHARD MILLER is:

- i. ?⁹ MILLER.

Descendants of Jeremiah Wadham

Generation No. 1

1. JEREMIAH¹ WADHAM was born Abt. 1750. He married ELIZABETH ROCK.

Children of JEREMIAH WADHAM and ELIZABETH ROCK are:

2. i. WILLIAM² WADHAM, b. 29 Dec 1777, London, England; d. 03 Mar 1832, Cockpit Alley, Southwark, London, England.
- ii. SARAH WADHAM, b. 17 Jul 1785.
- iii. THOMAS WADHAM, b. 14 Aug 1787.

Generation No. 2

2. WILLIAM² WADHAM (*JEREMIAH¹*) was born 29 Dec 1777 in London, England, and died 03 Mar 1832 in Cockpit Alley, Southwark, London, England. He married ROSE MERCHANT 23 Apr 1800 in Holborn St Giles in the Fields, England. She was born Abt. 1782 in England, and died 14 Jun 1833 in London, England.

Children of WILLIAM WADHAM and ROSE MERCHANT are:

3. i. ROSE ELIZA (SARAH)³ WADHAM, b. 18 Sep 1806, Southwark, Surrey, England; d. 12 Sep 1866, Moorabbin, Victoria, Australia.
4. ii. GEORGE WADHAM, b. 02 May 1801, Hospital, Endell St, Holborn, London; d. Mar 1858, Lancashire, United Kingdom.
5. iii. WILLIAM WADHAM, b. 15 Dec 1804, Southwark, Surrey, England; d. 25 Apr 1875, Lancashire, England.
6. iv. HARRIETT WADHAM, b. 15 Jan 1814, Southwark, Surrey, England; d. Mar 1886, London, United Kingdom.
- v. MARY ANN WADHAM, b. 30 Jul 1817, Southwark, Surrey, England; d. 1912, Strood, Kent.
- vi. CAROLINE WADHAM, b. 07 Aug 1821, Southwark, Surrey, England; d. Jul 1888, London, United Kingdom; m. (1) HENRY COLEBECK, 25 Dec 1844, Lambeth St John the Evangelist, England; b. 1822, Cripplegate, Middlesex, England; d. Mar 1881, London, United Kingdom; m. (2) WILLIAM CHARLES HOLDEN, 15 May 1881, St James the Great, Bethnal Green; b. 09 Dec 1831, Southwark, Surrey, England.

Generation No. 3

3. ROSE ELIZA (SARAH)³ WADHAM (*WILLIAM², JEREMIAH¹*) was born 18 Sep 1806 in Southwark, Surrey, England, and died 12 Sep 1866 in Moorabbin, Victoria, Australia. She married (1) WILLIAM PAINE 16 Oct 1827 in St Marys, Lambeth, Surrey. She married (2) WILLIAM EDWARD HOULDSWORTH 10 Jun 1833 in Longford, Tasmania. He was born 1799 in Manchester, England, and died 1859 in Ballarat, Victoria, Australia. She married (3) WILLIAM SEARS 12 Aug 1850 in St. Peters Church of England, Melbourne. He was born Nov 1800 in Hampstead Road, London, and died 19 May 1882 in Cheltenham, South Brighton, Melbourne, Victoria, Australia.

Children of ROSE WADHAM and WILLIAM HOULDSWORTH are:

7. i. WILLIAM EDWARD⁴ HALDSWORTH, b. 28 Apr 1837, Launceston, Tasmania; d. 06 Apr 1911, Prahran, Victoria.
- ii. BEAUTY ROSE ANN HALDSWORTH, b. 04 Dec 1838, Launceston, Tasmania; d. 15 Nov 1843, Launceston, Tasmania.
- iii. GEORGE HALDSWORTH, b. 18 Nov 1840, Launceston, Tasmania; d. 18 Dec 1840, Launceston, Tasmania.

Children of ROSE WADHAM and WILLIAM SEARS are:

8. iv. JOHN CHARLES⁴ SEARS, b. 17 Jan 1848, Collingwood, Victoria, Australia; d. 31 Jan 1849, Collingwood, Victoria, Australia.
- v. JAMES CHUTER (TUDOR) SEARS, b. 26 Aug 1846, Westbury, Tasmania; d. 01 Sep 1925, Thomsons Brook, Western Australia, Australia.

4. GEORGE³ WADHAM (*WILLIAM², JEREMIAH¹*) was born 02 May 1801 in Hospital, Endell St, Holborn, London, and died Mar 1858 in Lancashire, United Kingdom. He married HANNAH BEARD 06 Jul 1825 in Exeter, Devon, England. She was born 1801 in Dawlish, Devon, England.

Children of GEORGE WADHAM and HANNAH BEARD are:

9. i. ELIZABETH HANNAH⁴ WADHAM, b. 1827, Bermondsey, Surrey, England; d. 1901.
10. ii. GEORGE WILLIAM WADHAM, b. 03 May 1829, Bermondsey, Surrey, England; d. 03 Nov 1872, Liverpool, Lancashire, England.
- iii. EMMA MARY WADHAM, b. 31 Aug 1831, Bermondsey, Surrey, England; d. 24 Jan 1896, West Derby, Lancashire, United Kingdom.
- iv. THOMAS EDDIS WADHAM, b. 17 Jan 1834, Bermondsey, Surrey, England.
- v. CHARLOTTE ANNE WADHAM, b. Oct 1837, Starcross, Devon, England.
- vi. SOPHIA ROSE PACKER WADHAM, b. Jan 1841, Bermondsey, Surrey, England; m. JAMES ROBINSON, 27 Nov 1865.

5. WILLIAM³ WADHAM (*WILLIAM*², *JEREMIAH*¹) was born 15 Dec 1804 in Southwark, Surrey, England, and died 25 Apr 1875 in Lancashire, England. He married MARY PRIESTMAN. She was born 1810 in Oakham, Rutland, England, and died 09 Dec 1877 in Lancashire, England.

Children of WILLIAM WADHAM and MARY PRIESTMAN are:

- i. CAROLINE JANE⁴ WADHAM, b. 30 Aug 1836, London, Middlesex, England; d. 15 Dec 1896, Birkenhead, Merseyside, England.
- ii. MARY WADHAM, b. 1839, Manchester, Lancashire, England.
- iii. JOSEPH WADHAM, b. 1840, Liverpool, Lancashire, England; d. 1843, Lancashire, England.
- iv. ROSE WADHAM, b. 1845, Liverpool, Lancashire, England; d. Sep 1920, Strabane, Ireland.
- v. HENRY WADHAM, b. 1849, Liverpool, Lancashire, England.
- vi. HARRIET WADHAM, b. Abt. Jan 1844, Liverpool, Lancashire, England; d. 1846, West Derby, Lancashire, England.
- vii. WILLIAM WADHAM, b. Abt. 1834, Brixton, Surrey, England.
- viii. JAMES WADHAM, b. Abt. 1742, Aston, Warwickshire, England.
- ix. GEORGE WADHAM, b. 1744, Aston, Warwickshire, England; d. Jan 1903, Somerset, England.

6. HARRIETT³ WADHAM (*WILLIAM*², *JEREMIAH*¹) was born 15 Jan 1814 in Southwark, Surrey, England, and died Mar 1886 in London, United Kingdom. She married TIMOTHY MANNING 17 Mar 1836 in Lambeth St John the Evangelist, England. He was born 1812 in St Andrews, Middlesex, England, and died Dec 1879 in London, United Kingdom.

Children of HARRIETT WADHAM and TIMOTHY MANNING are:

- i. MARY ANN⁴ MANNING, b. 1835.
- ii. WILLIAM MANNING, b. 1837.
- iii. JAMES MANNING, b. 1839.
- iv. GEORGE MANNING, b. 1844.
- v. CHARLES MANNING, b. 1846.
- vi. CAROLINE MANNING, b. 1849.
- vii. HARRIETT MANNING, b. 1852.
- viii. HENRY MANNING, b. 1853.

Generation No. 4

7. WILLIAM EDWARD⁴ HALDSWORTH (*ROSE ELIZA (SARAH)*³ WADHAM, *WILLIAM*², *JEREMIAH*¹) was born 28 Apr 1837 in Launceston, Tasmania, and died 06 Apr 1911 in Prahran, Victoria. He married (1) MARY DEVEREAUX 13 Aug 1857 in Brighton, Victoria, Australia, daughter of PATRICK DEVEREAUX and JULIA ROYAL. She was born Abt. 1839, and died 21 Nov 1858 in Victoria, Australia. He married (2) ISABELLA GELLEY 31 Jan 1859 in St. Andrews Church, Brighton, daughter of JOHN GELLEY and CATHERINE CARMICHAEL. She was born 01 Jan 1840 in Alloa, Ayrshire, Scotland, and died 08 Feb 1919 in Prahran, Victoria.

Child of WILLIAM HALDSWORTH and MARY DEVEREAUX is:

- i. JAMES⁵ HALDSWORTH, b. Abt. 1858, Victoria, Australia; d. 27 Dec 1858, Portland, Victoria, Australia.

Children of WILLIAM HALDSWORTH and ISABELLA GELLEY are:

11. ii. ROSE-ANNE⁵ HALDSWORTH, b. 27 Jun 1861, Melbourne, Australia; d. 17 Oct 1926, Gisborne.
12. iii. JOHN HALDSWORTH, b. 24 Nov 1859, JimJim, Mt. Macedon; d. 02 Nov 1901, Prahran, Victoria.
13. iv. MARY HALDSWORTH, b. 05 Dec 1862, Moorabbin area of Melbourne; d. 21 Jan 1956, Fremantle, Western Australia, Australia.
 - v. WILLIAM EDWARD HALDSWORTH, b. 04 Jun 1866, Moorabbin area of Melbourne; d. Jul 1869, Mordialloc, Victoria, Australia.
14. vi. CATHERINE (KITTY) HALDSWORTH, b. 28 Dec 1867, Cheltenham, Victoria, Australia; d. Jan 1959, Spring, Victoria.
15. vii. ELIZABETH HALDSWORTH, b. 21 Dec 1872, Cheltenham, Victoria, AUS; d. Abt. 1963, Cheltenham, Victoria, AUS.
- viii. ISABELLA HALDSWORTH, b. 15 Nov 1869, Cheltenham, Victoria; d. Jul 1874, Mordialloc, Victoria, Australia.
16. ix. FLORENCE EVELYN HALDSWORTH, b. 23 Sep 1883, Prahran, Victoria; d. 22 Dec 1946, Prince Henry's Hospital, South Melbourne, Victoria.
17. x. MARIA HALDSWORTH, b. 18 Nov 1864, Cheltenham, Victoria; d. 1954, Will, Victoria.
18. xi. MARGARET HALDSWORTH, b. 18 Nov 1864, Moorabbin area of Melbourne; d. 1939, Woomdoo, Vic.
- xii. CHARLES WILLIAM HALDSWORTH, b. 18 Sep 1879, Cheltenham, Melbourne, Victoria; d. 08 Jun 1926, Prince Alfred Hospital, Victoria (suddenly following an operation); m. ANNIE JEAN SHEEHAN, 01 Feb 1905, Victoria; b. 13 Jun 1883, Dunkeld, Victoria, Australia; d. 14 Sep 1951, Fitzroy, Victoria, Australia.
- xiii. GEORGE HALDSWORTH, b. 02 Mar 1874, Moorabbin area of Melbourne; d. 11 Aug 1900, Prince Alfred Hospital, Victoria.
19. xiv. ISABELLA HALDSWORTH, b. 12 Apr 1877, Moorabbin area of Melbourne; d. 29 Apr 1934, Melbourne, Hospital, Victoria.
20. xv. SUSAN ELLEN (NELLIE) HALDSWORTH, b. 12 Mar 1881, Moorabbin area of Melbourne; d. 06 Feb 1964, Granville, New South Wales, Australia.
- xvi. SARAH MAY HALDSWORTH, b. 01 May 1884, Prahran, Victoria; d. Oct 1966, Victoria, Australia; m. JOHN (JACK) LYDSTER, 1906, Victoria, Australia; b. Abt. 1884, Hatfield, Yorkshire, England; d. 09 May 1968, South Brisbane, Queensland, Australia.
- xvii. ? HALDSWORTH, b. Mar 1876; d. Mar 1876.

8. JAMES CHUTER (TUDOR)⁴ SEARS (*ROSE ELIZA (SARAH)³ WADHAM, WILLIAM², JEREMIAH¹*) was born 26 Aug 1846 in Westbury, Tasmania, and died 01 Sep 1925 in Thomsons Brook, Western Australia, Australia. He married ELIZA ANN FLUCK 26 Feb 1866 in Melbourne, Victoria, Australia, daughter of JOHN FLUCK and CAROLINE ILES. She was born 07 Nov 1844 in Barton St Mary, Gloucestershire, and died 29 Jun 1916 in Alpha Park, Brookhampton, Thompsens Brook, Western Australia.

Children of JAMES SEARS and ELIZA FLUCK are:

21. i. JAMES ALBERT⁵ SEARS, b. 10 Jan 1879, Cheltenham, Victoria; d. 1951, Wellington, Western Australia.
22. ii. EMILY SARAH SEARS, b. Mar 1867, Cheltenham, Victoria.
- iii. PRISCILLA ANN SEARS, b. 1872, Cheltenham, Victoria; d. 24 Apr 1959, Melbourne, Victoria, Australia; m. (1) ? LEWIS; m. (2) HANS ANDREW FRANZEN, 1893, Victoria, Australia; b. Abt. 1867; d. 23 Dec 1904, Melbourne, Victoria, Australia.
 - iv. MARY ELIZABETH SEARS, b. 1870, Cheltenham, Victoria; d. 1878, Cheltenham, Victoria.
 - v. JAMES CHARLES SEARS, b. 1874, Cheltenham, Victoria; d. 1878, Cheltenham, Victoria.
 - vi. WILLIAM JOHN SEARS, b. 1876, Cheltenham, Victoria; d. 31 Jul 1950, Wellington, Western Australia; m. ELSIE CURTIS, 1914; b. Dec 1884; d. 16 Nov 1985.
23. vii. ALFRED SEARS, b. 29 Nov 1879, Cheltenham, Victoria; d. 26 May 1959, Perth, Western Australia.
- viii. ELIZA SEARS, b. Mar 1889, Cheltenham, Victoria; d. Mar 1889, Cheltenham, Victoria.
- ix. ALBERT HENRY SEARS, b. 1868, Cheltenham, Victoria; d. Sep 1878, Brighton, Victoria, Australia.

9. ELIZABETH HANNAH⁴ WADHAM (*GEORGE³, WILLIAM², JEREMIAH¹*) was born 1827 in Bermondsey, Surrey, England, and died 1901. She married (1) JOHN DENMEADE FLOOD 27 May 1849 in St Simon's, Liverpool, Lancashire, England. He was born Abt. 1826 in Ireland. She married (2) JOHNATHON KIRKHAM 28 Sep 1856 in St Nicholas, Liverpool, Lancashire, England. He was born Abt. 1834.

Children of ELIZABETH WADHAM and JOHN FLOOD are:

24. i. HENRY JAMES⁵ FLOOD, b. Jun 1850, Liverpool, Lancashire, England.
- ii. GEORGE WILLIAM FLOOD, b. Mar 1854, Lambeth, Surrey, England; d. 18 Jul 1900, New York, New York, USA.
- iii. ELIZA JANE FLOOD, b. 1858.
- iv. HANNA FLOOD, b. 09 Apr 1865, Saint John, Limerick, Ireland.
25. v. ELIZABETH FLOOD, b. 12 Apr 1867, Saint John, Limerick, Ireland.

10. GEORGE WILLIAM⁴ WADHAM (*GEORGE*³, *WILLIAM*², *JEREMIAH*¹) was born 03 May 1829 in Bermondsey, Surrey, England, and died 03 Nov 1872 in Liverpool, Lancashire, England. He married MARY WALSH 22 Oct 1854 in Liverpool, Lancashire, England. She was born 31 Dec 1828 in Wakefield, Yorkshire, England, and died Oct 1872 in Liverpool, Lancashire, England.

Children of GEORGE WADHAM and MARY WALSH are:

- i. MARTHA⁵ WADHAM, b. 1852, Liverpool, Lancashire, England.
- ii. ADA WADHAM, b. 03 Jan 1858, Liverpool, Lancashire, England; d. 03 Jan 1945, 15 Fairholme Road, Withington, Manchester, Lancashire, England.
- iii. MARY EMMA WADHAM, b. Abt. Mar 1860, Liverpool, Lancashire, England.
- iv. WILLIAM WADHAM, b. Abt. Dec 1862, Liverpool, Lancashire, England; d. 09 Sep 1924.
- v. EDWARD W WADHAM, b. Abt. 1865, Liverpool, Lancashire, England.
- vi. MARY S WADHAM, b. Abt. 1867, Liverpool, Lancashire, England.
- vii. GEORGE ERNEST WADHAM, b. Jul 1867, Liverpool, Lancashire, England; d. 27 Aug 1933, Birkenhead, Cheshire, England.
- viii. WALTER WADHAM.

Generation No. 5

11. ROSE-ANNE⁵ HALDSWORTH (*WILLIAM EDWARD*⁴, *ROSE ELIZA (SARAH)*³ *WADHAM*, *WILLIAM*², *JEREMIAH*¹) was born 27 Jun 1861 in Melbourne, Australia, and died 17 Oct 1926 in Gisborne. She married ARTHUR STAGGARD 1884 in Tasmania, son of THOMAS STAGGARD and HANNAH SMITH. He was born 14 Aug 1858 in Westbury, Tasmania, Australia, and died 04 Apr 1909 in Clifton Hill, Borondara, Melbourne, Australia.

Children of ROSE-ANNE HALDSWORTH and ARTHUR STAGGARD are:

26. i. RUBY FRANCES⁶ STAGGARD, b. 27 Feb 1885, Glenferrie, Victoria, Australia; d. 19 Jul 1989, St John's Hospital, Pah Rd, Epsom, Auckland.
- ii. LESLIE THOMAS STAGGARD, b. 22 Sep 1889, Hawthorn, Kooyong, Victoria, Australia; d. 28 Mar 1958, Auckland.
- iii. PERCIVAL ARTHUR STAGGARD, b. 22 Nov 1886, Hawthorn, Kooyong, Victoria, Australia; d. 31 Jan 1914, 145 Joel Terrace, Mt Lawley, Perth, Western Australia.

12. JOHN⁵ HALDSWORTH (*WILLIAM EDWARD*⁴, *ROSE ELIZA (SARAH)*³ *WADHAM*, *WILLIAM*², *JEREMIAH*¹) was born 24 Nov 1859 in JimJim, Mt. Macedon, and died 02 Nov 1901 in Prahran, Victoria. He married ROSA ELLEN MOON, daughter of ALFRED MOON and MARY HULMN. She was born 1861 in Prahran, Victoria, Australia, and died 03 Dec 1944 in Private Hospital, Middle Brighton, Melbourne.

Children of JOHN HALDSWORTH and ROSA MOON are:

- i. ETHEL MAY ELIZA⁶ HALDSWORTH, b. 1884, Bright, Victoria, Australia; d. 1977, Rosebud, Victoria; m. HENRY RICHARD ALLDERSEA WATSON, 1912, Elsternwick, Victoria, Australia; b. 04 Jan 1884, Marylands, Sth Australia; d. 1953, Caulfield, Victoria, Australia.
- ii. WILLIAM ALFRED HALDSWORTH, b. 1885, Bright, Victoria, Australia.
27. iii. FLORENCE VIOLET HALDSWORTH, b. 1888, Elsternwick, Victoria, Australia; d. 1962, Bright, Victoria, Australia.
28. iv. ROSA ISABEL LILLIAN HALDSWORTH, b. 1890, Elsternwick, Victoria, Australia; d. Bef. 1944.
- v. JOHN CHARLES HALDSWORTH, b. 1893, Elsternwick, Victoria, Australia; d. 1894, Elsternwick, Victoria, Australia.
29. vi. LILLIAN GRACE HALDSWORTH, b. 21 Apr 1896, Elsternwick, Victoria, Australia; d. 1978, Prahran, Victoria, Australia.
30. vii. ISABELLA HALDSWORTH, b. 1900, Elsternwick, Victoria, Australia; d. Rosebud, Victoria, Australia.

13. MARY⁵ HALDSWORTH (*WILLIAM EDWARD*⁴, *ROSE ELIZA (SARAH)*³ *WADHAM*, *WILLIAM*², *JEREMIAH*¹) was born 05 Dec 1862 in Moorabbin area of Melbourne, and died 21 Jan 1956 in Fremantle, Western Australia, Australia. She married JOSEPH CURTES SEMKEN 1880, son of WILLIAM SEMKEN and EMMA LAWRENCE. He was born 12 Sep 1858 in Brighton, Victoria, Australia, and died 05 Apr 1932 in Cottesloe, Western Australia, Australia.

Children of MARY HALDSWORTH and JOSEPH SEMKEN are:

- i. MURIEL JESSIE⁶ SEMKEN, b. 1892, Brighton, Victoria, Australia; d. Jul 1981, Northcote, Victoria, Australia; m. EDWARD (DARCY) ECCLES, 1917, St Patrick's, Ferntree Gully, Victoria; b. 1881, Kyneton, Victoria, Australia; d. 1964, Fitzroy, Victoria, Australia.
- ii. FREDERICK JOSEPH SEMKEN, b. Jul 1884, Brighton, Victoria, Australia; d. 21 Nov 1921, Perth, Western Australia.
31. iii. WILLIAM JAMES SEMKEN, b. 1886, Brighton, Victoria, Australia; d. 21 Jul 1976, Cronulla.
- iv. HERBERT WILLIAM SEMKEN, b. 1882, Brighton, Victoria, Australia; d. 29 Dec 1914, Claremont, Western Australia, Australia.
- v. LESLIE GELLIE SEMKEN, b. 1881, Brighton, Victoria, Australia; d. 12 Aug 1955, Heidelberg, Victoria; m. THERESA ELIZABETH GOODWIN SMITH, 1925, Jones Creek, Dunolly, Victoria, Australia; b. 1878; d. 1948, Campbellfield, Victoria.

14. CATHERINE (KITTY)⁵ HALDSWORTH (*WILLIAM EDWARD*⁴, *ROSE ELIZA (SARAH)*³ *WADHAM*, *WILLIAM*², *JEREMIAH*¹) was born 28 Dec 1867 in Cheltenham, Victoria, Australia, and died Jan 1959 in Spring, Victoria. She married WILLIAM WHITTINGTON 09 Nov 1892 in William & Isabella Haldsworth's residence, 46 Upton Rd, Windsor, Australia, son of JEREMIAH WHITTINGTON and ANNIE DOBBIE. He was born 1863 in Ballarat, Victoria, and died Mar 1946 in Hawthorn, Victoria.

Children of CATHERINE HALDSWORTH and WILLIAM WHITTINGTON are:

- i. FRANCIS WILLIAM CAMPBELL⁶ WHITTINGTON, b. 1896, Hawthorn, Victoria; d. 27 Oct 1988, Rosebud, Victoria, Australia; m. MABEL ELIZABETH BOWERS; b. Abt. 1896; d. May 1962, Malvern, Victoria.
- ii. RICHARD WALLACE WHITTINGTON, b. 1900, Hawthorn, Victoria; d. 05 Nov 1977, Victoria, Australia; m. MARY FRANCES HOGAN, 20 Nov 1923, Malvern, Victoria; b. 1902, Chewton, Victoria.

15. ELIZABETH⁵ HALDSWORTH (*WILLIAM EDWARD*⁴, *ROSE ELIZA (SARAH)*³ *WADHAM*, *WILLIAM*², *JEREMIAH*¹) was born 21 Dec 1872 in Cheltenham, Victoria, AUS, and died Abt. 1963 in Cheltenham, Victoria, AUS. She married (1) WILLIAM JOHN SEARS. She married (2) WILLIAM LAIDLAW 1896 in Victoria, Australia, son of WALTER LAIDLAW and ELSPETH MCGEACHIN. He was born 19 Oct 1869 in Scarsdale, Victoria, and died 02 Jun 1948 in Mentone, Victoria, Australia.

Children of ELIZABETH HALDSWORTH and WILLIAM SEARS are:

- i. WILLIAM GEORGE⁶ SEARS, b. 28 Apr 1901.
- ii. ISOBEL GELLEY SEARS.
- iii. ELIZABETH SEARS.
- iv. GEORGE EDWARD JOHN SEARS.

Children of ELIZABETH HALDSWORTH and WILLIAM LAIDLAW are:

- v. ISABELL EILEEN⁶ LAIDLAW, b. 1914, Oakleigh, Victoria, AUS; d. 23 Sep 1976, Sandringham, Victoria, AUS; m. ALLAN DAVID WHITE; b. 23 Sep 1912, Cheltenham, Victoria, AUS; d. 30 Apr 1989.
- vi. ISABELLA GELLIE LAIDLAW, b. 1903, South Yarra, Victoria, Australia; d. 1903, South Yarra, Victoria, Australia.
- vii. GEORGE HALDSWORTH LAIDLAW, b. 1903, South Yarra, Victoria, Australia.
- viii. ELIZABETH MIDDLEMASS LAIDLAW, b. 1903, South Yarra, Victoria, Australia; d. 1903, South Yarra, Victoria, Australia.
- ix. WALTER WILLIAM GEORGE LAIDLAW, b. 1901, South Yarra, Victoria, Australia; d. 1971, Kyabram, Victoria, Australia; m. RUTH ELIZABETH LAWRENCE, 22 May 1933, St Georges, Carlton, Victoria, Australia.
- x. ELSPETH MCGEACHIN LAIDLAW, b. 1899, South Yarra, Victoria, Australia; m. EDWARD ALGERNON LEVECKE; b. 1900, Amphitheatre, Victoria.
- xi. VIOLET MYRTLE LAIDLAW, b. 1898, South Yarra, Victoria, Australia; d. Dec 1971; m. HORACE ROBERT LEEK; d. Oct 1956.

16. FLORENCE EVELYN⁵ HALDSWORTH (*WILLIAM EDWARD*⁴, *ROSE ELIZA (SARAH)*³ *WADHAM*, *WILLIAM*², *JEREMIAH*¹) was born 23 Sep 1883 in Prahran, Victoria, and died 22 Dec 1946 in Prince Henry's Hospital, South Melbourne, Victoria. She married GEORGE WAITE 1913 in Victoria, Australia, son of OLIVER WAITE and MARTHA HILL. He was born 1885 in Caulfield, Victoria, and died 21 Dec 1946 in 22 Head St, Elwood, Victoria.

Child of FLORENCE HALDSWORTH and GEORGE WAITE is:

- i. RONALD WILLIAM⁶ WAITE, b. 16 Dec 1915, South Yarra, Victoria, Australia; d. 20 Nov 1943, Kilmore, Victoria; m. BETTY WINSTEN ?.

17. MARIA⁵ HALDSWORTH (*WILLIAM EDWARD⁴, ROSE ELIZA (SARAH)³ WADHAM, WILLIAM², JEREMIAH¹*) was born 18 Nov 1864 in Cheltenham, Victoria, and died 1954 in Will, Victoria. She married FREDERICK WALTERS 22 Apr 1886 in Victoria, Australia, son of JOHN WALTERS and ELIZABETH POOLE. He was born 26 Sep 1862 in Bridgewater Somerset, and died 22 May 1950 in Essendon, Victoria, Australia.

Children of MARIA HALDSWORTH and FREDERICK WALTERS are:

32.
 - i. LILLIAN GRACE⁶ WALTERS, b. 26 Jan 1887, Hawthorn, Victoria, Australia; d. 20 Dec 1958, Thornleigh, New South Wales, Australia.
 - ii. FREDERICK JOHN WALTERS, b. 1890, Hawthorn, Victoria, Australia; d. 1962, Fitzroy, Victoria, Australia; m. EILEEN DOROTHY MYERS, 1928, Victoria, Australia; b. 1896, Melbourne South, Victoria, Australia.
 - iii. HAROLD WILLIAM ROY WALTERS, b. 1893, Hawthorn, Victoria, Australia; d. 17 Sep 1951, Victoria, Australia.
33.
 - iv. ISABELL MYRTLE IRENE WALTERS, b. 31 Aug 1901, Hawthorn, Victoria, Australia; d. 02 Aug 1974, Williamstown, Vic. Australia.

18. MARGARET⁵ HALDSWORTH (*WILLIAM EDWARD⁴, ROSE ELIZA (SARAH)³ WADHAM, WILLIAM², JEREMIAH¹*) was born 18 Nov 1864 in Moorabbin area of Melbourne, and died 1939 in Woorndoo, Vic. She married (2) ARTHUR WILLIAM HENRY BARR 1884 in Victoria, Australia, son of BENJAMIN BARR and MARY VEMUEL. He was born 1862 in Woodford, Victoria, Australia, and died 02 Feb 1924 in Yea, Victoria, Australia.

Child of MARGARET HALDSWORTH is:

- i. FLORENCE DOLENA ANN⁶ HALDSWORTH, b. 1880, Cheltenham, Victoria; d. 10 Feb 1880, Mordialloc, Victoria, Australia.

Children of MARGARET HALDSWORTH and ARTHUR BARR are:

- ii. PERCY⁶ BARR, b. 1884, Victoria, Australia; d. 1898, Richmond, Victoria, Australia.
34.
 - iii. BERTHA BEATRICE GERTRUDE BARR, b. Aug 1885, Prahran, Victoria, Australia; d. 22 Sep 1953, Glen Waverly, Victoria.
35.
 - iv. ELSIE VIOLET VICTORIA BARR, b. 1887, Bright, Victoria, Australia; d. 31 May 1971.
36.
 - v. HORACE HORSFORD BARR, b. Jun 1890, Clifton Hill, Victoria, Australia; d. 30 Nov 1951, Dandenong, Victoria.

19. ISABELLA⁵ HALDSWORTH (*WILLIAM EDWARD⁴, ROSE ELIZA (SARAH)³ WADHAM, WILLIAM², JEREMIAH¹*) was born 12 Apr 1877 in Moorabbin area of Melbourne, and died 29 Apr 1934 in Melbourne, Hospital, Victoria. She married CARLYLE WILLIAM AFFLECK 1904 in Victoria, Australia, son of WILLIAM AFFLECK and JANE WELLS. He was born 12 Jan 1876 in Woodend, Victoria, Australia, and died Sep 1934 in Hawthorn, Victoria Australia.

Children of ISABELLA HALDSWORTH and CARLYLE AFFLECK are:

37.
 - i. GEORGE CARLYLE⁶ AFFLECK, b. 23 May 1905, Prahran, Victoria, Australia; d. 1973, Heidelberg, Victoria, Australia.
 - ii. EUNICE ISABEL JANET AFFLECK, b. 23 Dec 1910, Victoria, Australia; d. 09 Jun 1985, Victoria, Australia; m. CHARLES JOHN (JACK) BATH, 1937; b. Abt. 1905, Yarra Glen, Victoria; d. 18 May 1970, Park, Victoria.
 - iii. VIOLET MABEL AFFLECK, b. 03 Sep 1915; d. Sep 1997, Richmond Upon Thames, Surrey, England; m. EDWARD ARTHUR ROGERSON, 06 Nov 1942, South Yarra, Victoria, Australia; b. Abt. 1913; d. 1970, Perth, Western Australia, Australia.
 - iv. MARGARET JESSIE AFFLECK, b. Abt. 1915, Victoria, Australia; d. Abt. 1985, Victoria, Australia; m. (1) ALBERT NORMAN ANSELEY LINCOLN, Abt. 1940, Victoria, Australia; b. 1915; d. 1979; m. (2) BASIL ROBERT MAGGS, Abt. 1951, Victoria, Australia; b. 05 May 1911, Ringwood, Victoria, Australia; d. 19 Mar 1998, Lilydale, Victoria, Australia.

20. SUSAN ELLEN (NELLIE)⁵ HALDSWORTH (*WILLIAM EDWARD⁴, ROSE ELIZA (SARAH)³ WADHAM, WILLIAM², JEREMIAH¹*) was born 12 Mar 1881 in Moorabbin area of Melbourne, and died 06 Feb 1964 in Granville, New South Wales, Australia. She married WILLIAM CHARLES FRANCIS 28 Jul 1903 in Pymont, New South Wales, Australia, son of WILLIAM FRANCIS and MARY POOLE. He was born 27 Sep 1860 in Bridgewater, Somerset, England, and died 20 Feb 1922 in Granville, NSW, Australia.

Children of SUSAN HALDSWORTH and WILLIAM FRANCIS are:

38. i. ISABELLA MARY⁶ FRANCIS, b. 26 Sep 1904, Granville, NSW, Australia; d. 27 Feb 1987, Camden, New South Wales, Australia.
39. ii. CHARLES EDWARD FRANCIS, b. 31 Dec 1905, Granville, NSW, Australia; d. 21 Nov 1978, Sunnybank, Queensland, Australia.
- iii. HENRY CARLYLE FRANCIS, b. 04 Sep 1908, Granville, NSW, Australia; d. 06 Dec 1990, Concord West, NSW, Australia; m. FRED A MARY O'KEEFE; d. 07 Aug 1988, Concord West, NSW, Australia.
40. iv. GRACE EVELYN FRANCIS, b. 11 Nov 1918, Granville, NSW, Australia; d. 04 May 1998, Epping, New South Wales, Australia.
41. v. GEORGE WILLIAM FRANCIS, b. 25 Feb 1914, Granville, NSW, Australia; d. 31 Aug 1990, North Parramatta, NSW, Australia.
- vi. JOHN LEONARD (JACK) FRANCIS, b. Abt. 1916, Granville, NSW, Australia; d. 20 Mar 1988, New South Wales, Australia; m. EILEEN ?.

21. JAMES ALBERT⁵ SEARS (*JAMES CHUTER (TUDOR)*⁴, *ROSE ELIZA (SARAH)*³ *WADHAM, WILLIAM*², *JEREMIAH*¹) was born 10 Jan 1879 in Cheltenham, Victoria, and died 1951 in Wellington, Western Australia. He married SUSAN AMY WEBSTER 1907 in Wellington, Western Australia, daughter of JOHN WEBSTER and MARY HIND. She was born 11 Feb 1885 in Grantham, Lincolnshire, United Kingdom, and died 1977 in Wellington, Western Australia.

Child of JAMES SEARS and SUSAN WEBSTER is:

42. i. ERNEST⁶ SEARS, b. 19 Mar 1946; d. 06 Jun 1999.

22. EMILY SARAH⁵ SEARS (*JAMES CHUTER (TUDOR)*⁴, *ROSE ELIZA (SARAH)*³ *WADHAM, WILLIAM*², *JEREMIAH*¹) was born Mar 1867 in Cheltenham, Victoria. She married JAMES PETER FLINN 17 Dec 1887 in Keys Rd, Sth Brighton, Victoria, Australia. He was born Mar 1861 in Melbourne, Victoria, and died 1961 in Ballarat, Victoria, Australia.

Children of EMILY SEARS and JAMES FLINN are:

- i. ALFRED GEORGE⁶ FLINN, b. Jan 1890, Cheltenham, Victoria; d. Feb 1890, Cheltenham, Victoria.
- ii. JAMES CHUTER FLINN, b. 1890, Cheltenham, Victoria; d. 1891, Carlton, Victoria.
- iii. ELIZABETH FLINN, b. Abt. 1892, Carlton, Victoria.
43. iv. ALBERT HENRY SEARS FLINN, b. 17 May 1894, Carlton, Victoria; d. 07 Oct 1986, Hollywood, Western Australia.

23. ALFRED⁵ SEARS (*JAMES CHUTER (TUDOR)*⁴, *ROSE ELIZA (SARAH)*³ *WADHAM, WILLIAM*², *JEREMIAH*¹) was born 29 Nov 1879 in Cheltenham, Victoria, and died 26 May 1959 in Perth, Western Australia. He married (1) ALMA MURIEL WOOD 25 Dec 1908 in Donnybrook, Western Australia, Australia, daughter of BASIL WOOD and JULIA WHITEHEAD. She was born 01 Sep 1885 in Sydney, New South Wales, Australia, and died 12 Jul 1915 in Donnybrook, Western Australia, Australia. He married (2) ETHEL MAY WALLACE 1921 in Perth, Western Australia.

Children of ALFRED SEARS and ALMA WOOD are:

- i. SYDNEY GEORGE ALFRED⁶ SEARS, b. 27 Sep 1913, Donnybrook, WA, Australia; d. 1979, Fremantle, Western Australia; m. EDITH MAY GREEN, 04 Dec 1939, Bunbury, WA, Australia; b. 20 Apr 1916, Claremont, WA, Australia; d. 1962, Fremantle, WA, Australia.
- ii. ALMA MAY SEARS, b. 10 Jul 1915, Donnybrook, WA, Australia.

24. GEORGE WILLIAM⁵ FLOOD (*ELIZABETH HANNAH*⁴ *WADHAM, GEORGE*³, *WILLIAM*², *JEREMIAH*¹) was born Mar 1854 in Lambeth, Surrey, England, and died 18 Jul 1900 in New York, New York, USA. He married ELLEN J HODGES 13 Jun 1880 in St Vincent Ferrer Church, New York City, New York, USA. She was born Jul 1853 in Ireland, and died 29 Jul 1920 in Manhattan, New York, New York, USA.

Children of GEORGE FLOOD and ELLEN HODGES are:

- i. ELIZABETH AGNES⁶ FLOOD, b. Abt. 1882, New York, New York, USA.
- ii. ELEANOR FLOOD, b. 13 Apr 1883, New York, New York, USA.
- iii. GEORGE WILLIAM FLOOD, b. 04 Sep 1886, New York, New York, USA.
- iv. MARGUERITE FLOOD, b. 15 Sep 1887, New York, New York, USA.
- v. MARY JOSEPHINE FLOOD, b. 14 Apr 1889, New York, New York, USA.
- vi. EMMA CECELIA FLOOD, b. 16 Nov 1890, New York, New York, USA.
- vii. OLIVE AGNES FLOOD, b. 04 Dec 1891, New York, New York, USA.
- viii. ADA BENDICTA FLOOD, b. 04 Aug 1893, New York, New York, USA.
- ix. CARRIE FLOOD, b. 1895, New York, New York, USA.
- x. HENRY JOHN FLOOD, b. 26 Feb 1896, New York, New York, USA.
- xi. JAMES ALOYSIUS FLOOD, b. 07 Jan 1897, New York, New York, USA.

25. ELIZABETH⁵ FLOOD (*ELIZABETH HANNAH⁴ WADHAM, GEORGE³, WILLIAM², JEREMIAH¹*) was born 12 Apr 1867 in Saint John, Limerick, Ireland. She married WILLIAM HODGES 20 Aug 1893 in Manhattan, New York, New York, USA. He was born Aug 1842 in Caunty, Limerick, Ireland.

Children of ELIZABETH FLOOD and WILLIAM HODGES are:

- i. JOHN⁶ HODGES, b. 1888, New York, New York, USA.
- ii. MARY HODGES, b. 1898, New York, New York, USA.

Generation No. 6

26. RUBY FRANCES⁶ STAGGARD (*ROSE-ANNE⁵ HALDSWORTH, WILLIAM EDWARD⁴, ROSE ELIZA (SARAH)³ WADHAM, WILLIAM², JEREMIAH¹*) was born 27 Feb 1885 in Glenferrie, Victoria, Australia, and died 19 Jul 1989 in St John's Hospital, Pah Rd, Epsom, Auckland. She married (1) NORMAN (NORRIE) FREDERICK JAMES HANDRICKS 06 Dec 1911 in Christian Chapel, Church of Christ, Hawthorn, Victoria, Australia, son of JOZEF HANDRICKS and SARAH MCKENNA. He was born 06 Dec 1879 in Port Fairy, Victoria, Australia, and died 04 Sep 1936 in Auckland. She married (2) JAMES GAM GOON LEE 1953, son of JAMES LEE and EMILY NEAL. He was born 25 Sep 1880 in Ashburton, Canterbury, New Zealand, and died 21 May 1960 in Auckland.

Children of RUBY STAGGARD and NORMAN HANDRICKS are:

44. i. EDWIN (EDDIE) LISTER⁷ HANDRICKS, b. 05 Mar 1926, Lister Hospital, Riverside Road, Gisborne; d. 01 May 2011, Middlemore Hospital, Auckland.
- ii. GWENDOLINE ROSE CORRICK HANDRICKS, b. 03 Oct 1912, Granville, Sydney; d. 02 Nov 2000, Auckland Hospital, Auckland, New Zealand.
45. iii. ROBERT HARRY HANDRICKS, b. 08 Apr 1920, Gisborne; d. 07 Aug 2007, Dargaville.
46. iv. NORMAN LESLIE HANDRICKS, b. 19 Sep 1915, Wellington; d. 27 Jan 2004, Whakatane.
47. v. DOUGLAS HUBERT NELSON HANDRICKS, b. 25 Aug 1917, Nelson; d. 09 May 1981, Sydney.
- vi. WILLIAM HANDRICKS, b. 08 Apr 1920, Gisborne; d. 08 Apr 1920, Gisborne.

27. FLORENCE VIOLET⁶ HALDSWORTH (*JOHN⁵, WILLIAM EDWARD⁴, ROSE ELIZA (SARAH)³ WADHAM, WILLIAM², JEREMIAH¹*) was born 1888 in Elsternwick, Victoria, Australia, and died 1962 in Bright, Victoria, Australia. She married (1) ALFRED HERBERT GEORGE CORYNDON BEGBIE 1909 in Victoria, Australia, son of GEORGE BEGBIE and ELIZABETH ?. He was born 1888, and died 31 Aug 1918 in WWi, France. She married (2) ARTHUR HENRY WARBURTON 1920 in Victoria, Australia.

Children of FLORENCE HALDSWORTH and ALFRED BEGBIE are:

- i. JEAN RAY⁷ BEGBIE, b. 1910, Elsternwick, Victoria, Australia; d. 1935.
- ii. DELIA ROSA BEGBIE, b. 1911; d. 1984, Rye, Victoria; m. ? PRATT.

28. ROSA ISABEL LILLIAN⁶ HALDSWORTH (*JOHN⁵, WILLIAM EDWARD⁴, ROSE ELIZA (SARAH)³ WADHAM, WILLIAM², JEREMIAH¹*) was born 1890 in Elsternwick, Victoria, Australia, and died Bef. 1944. She married JOHN WILLIAM PAGE.

Child of ROSA HALDSWORTH and JOHN PAGE is:

- i. DORIS⁷ PAGE, b. 1913, Victoria, Australia; d. 1972; m. CLIFFORD ALEXANDER LARS MOON; b. 1914, Fitzroy, Victoria; d. 1985.

29. LILLIAN GRACE⁶ HALDSWORTH (*JOHN*⁵, *WILLIAM EDWARD*⁴, *ROSE ELIZA (SARAH)*³ *WADHAM*, *WILLIAM*², *JEREMIAH*¹) was born 21 Apr 1896 in Elsternwick, Victoria, Australia, and died 1978 in Prahran, Victoria, Australia. She married JAMES BRACEBRIDGE WILSON. He was born 1891 in Hawthorn, Victoria, and died 1984 in Sandford, Victoria.

Children of LILLIAN HALDSWORTH and JAMES WILSON are:

- i. ?⁷ WILSON.
- ii. ? WILSON.
- iii. ? WILSON.
- iv. ? WILSON.

30. ISABELLA⁶ HALDSWORTH (*JOHN*⁵, *WILLIAM EDWARD*⁴, *ROSE ELIZA (SARAH)*³ *WADHAM*, *WILLIAM*², *JEREMIAH*¹) was born 1900 in Elsternwick, Victoria, Australia, and died in Rosebud, Victoria, Australia. She married RUDOLF KARL ANDREASON 1928 in Melbourne, Victoria, Australia. He was born 16 Apr 1907 in Copenhagen, Denmark, and died 27 May 2009 in Rosebud, Victoria, Australia.

Children of ISABELLA HALDSWORTH and RUDOLF ANDREASON are:

- i. BARRY JOHN⁷ ANDREASON, b. 16 Aug 1931, Melbourne; d. 19 Mar 2010, Rosebud, Victoria, Australia; m. NORMA MAE HADDON.
- ii. ? ANDREASON.

31. WILLIAM JAMES⁶ SEMKEN (*MARY*⁵ *HALDSWORTH*, *WILLIAM EDWARD*⁴, *ROSE ELIZA (SARAH)*³ *WADHAM*, *WILLIAM*², *JEREMIAH*¹) was born 1886 in Brighton, Victoria, Australia, and died 21 Jul 1976 in Cronulla. He married JOSEPHINE MABEL BEARDWOOD 16 Oct 1920 in The Deanery, Launceston, Tasmania, Australia. She was born 1890 in Launceston, Tasmania, and died 18 Feb 1937 in Kingsford, New South Wales.

Children of WILLIAM SEMKEN and JOSEPHINE BEARDWOOD are:

- i. JOSEPHINE MABEL⁷ SEMKEN, b. 12 May 1932; d. 13 May 2017, Thirlmere, New South Wales, Australia; m. ALFRED LLOYD HAND, 1952, Kogarah, New South Wales, Australia; b. 1926; d. 1994.
- ii. KEITH WALTER SEMKEN, b. 1928; d. 23 Feb 2009, Berry Park, New South Wales, Australia; m. JEANNE ROSEMARY BRYANT, 1953, Sutherland, New South Wales, Australia; b. 1931; d. 2010.
- iii. MARY ANITA SEMKEN, b. 22 Dec 1923, Eltham, Victoria, Australia; d. 03 Jan 1977, Engadine, New South Wales, Australia; m. TIMOTHY JOHN LONERGAN, 1952, Kogarah, New South Wales, Australia; b. 04 Sep 1909, Sydney, New South Wales, Australia; d. 04 Aug 1996, Ballina, New South Wales, Australia.
- iv. FREDERICK WILLIAM SEMKEN, b. 1923, Burnie, Tasmania, Australia; d. 28 Nov 1938, St George District Hospital Kogarah, New South Wales, Australia.
- v. LESLIE HERBERT SEMKEN, b. 20 Mar 1921, Burnie, Tasmania, Australia; d. 25 Jan 2012, Caringbah, New South Wales, Australia.

32. LILLIAN GRACE⁶ WALTERS (*MARIA*⁵ *HALDSWORTH*, *WILLIAM EDWARD*⁴, *ROSE ELIZA (SARAH)*³ *WADHAM*, *WILLIAM*², *JEREMIAH*¹) was born 26 Jan 1887 in Hawthorn, Victoria, Australia, and died 20 Dec 1958 in Thornleigh, New South Wales, Australia. She married RAYMOND LESLIE GORDON ROWE, son of HENRY ROWE and CATHERINE HAEFFNER. He was born 02 Sep 1885 in Beechworth, Vic, and died 05 Jul 1966 in Thornleigh, New South Wales, Australia.

Children of LILLIAN WALTERS and RAYMOND ROWE are:

- i. DORA MYRTLE⁷ ROWE, b. 22 Feb 1920; d. 31 Aug 2014, Sydney, Australia; m. HARRY EDWARD THOMAS BUCKERIDGE.
- ii. JACK ROWE.
- iii. JOY ROWE.

33. ISABELL MYRTLE IRENE⁶ WALTERS (*MARIA*⁵ *HALDSWORTH*, *WILLIAM EDWARD*⁴, *ROSE ELIZA (SARAH)*³ *WADHAM*, *WILLIAM*², *JEREMIAH*¹) was born 31 Aug 1901 in Hawthorn, Victoria, Australia, and died 02 Aug 1974 in Williamstown, Vic. Australia. She married CHARLES MCKINLEY YOUNG. He was born 29 Jun 1893 in Paisley Scotland, and died 15 Aug 1968 in Williamstown, Vic. Australia.

Children of ISABELL WALTERS and CHARLES YOUNG are:

- i. ELIZABETH (BETTY)⁷ YOUNG.
- ii. IAN YOUNG.
- iii. KEITH YOUNG.

34. BERTHA BEATRICE GERTRUDE⁶ BARR (*MARGARET⁵ HALDSWORTH, WILLIAM EDWARD⁴, ROSE ELIZA (SARAH)³ WADHAM, WILLIAM², JEREMIAH¹*) was born Aug 1885 in Prahran, Victoria, Australia, and died 22 Sep 1953 in Glen Waverly, Victoria. She married SAMUEL PERCIVAL BRADFORD 1905 in Victoria, Australia. He was born 11 Mar 1874 in USA, and died 06 Jan 1947.

Children of BERTHA BARR and SAMUEL BRADFORD are:

48. i. PERCIVAL SAMUEL⁷ BRADFORD, b. 15 Jan 1906, Whittlesea, Victoria, Australia; d. 30 Nov 1967, Terang, Victoria, Australia.
- ii. MARGARET GERTRUDE VICTORIA BRADFORD, b. 31 Mar 1907, Whittlesea, Victoria, Australia; d. 12 Nov 1996, Victoria, Australia; m. WILLIAM STANLEY ROPER, 27 Mar 1937, Daylesford, Victoria, Australia; b. Jul 1901, Ipswich, Suffolk, England; d. 19 Aug 1972, Preston, Victoria.
49. iii. ETHEL ISABELLA MARY BRADFORD, b. 21 Mar 1909, Whittlesea, Victoria, Australia.
- iv. WILLIAM CHARLES BRADFORD, b. 15 Feb 1915, Brunswick, Victoria, Australia.
- v. BERTHA BEATRICE ALMA BRADFORD, b. 1911, Victoria, Australia; m. EARL GAMMON, 1938, Victoria, Australia.
- vi. EDNA MAY VIOLET BRADFORD, b. Abt. 1913; d. 20 Jan 1967, Newport, Victoria; m. GEORGE JASON FERRY, 05 Sep 1934, Kerang, Victoria, Australia.
- vii. ARTHUR HENRY BRADFORD, b. 02 Apr 1917, Brunswick, Victoria, Australia; m. (1) JEAN ?; m. (2) FRANCES ELOISE JOBSON.

35. ELSIE VIOLET VICTORIA⁶ BARR (*MARGARET⁵ HALDSWORTH, WILLIAM EDWARD⁴, ROSE ELIZA (SARAH)³ WADHAM, WILLIAM², JEREMIAH¹*) was born 1887 in Bright, Victoria, Australia, and died 31 May 1971. She married NORMAN ARCHIBALD HOLMAN MCPHEE. He died 28 Jun 1922.

Children of ELSIE BARR and NORMAN MCPHEE are:

- i. LORNA MARJORIE⁷ MCPHEE, b. 1913, Preston, Victoria, Australia; d. 03 Mar 1989, Victoria, Australia; m. (1) GEORGE EATON HANNAFORD; b. 1906, Victoria, Australia; d. 1971, Victoria, Australia; m. (2) DAVID WILLIAM RAINEY; b. 15 Oct 1920, Heathcote, Victoria, Australia; d. 1995, Victoria, Australia.
- ii. VIOLET MARGARET MCPHEE, d. 1915, Brunswick East, Victoria.

36. HORACE HORSFORD⁶ BARR (*MARGARET⁵ HALDSWORTH, WILLIAM EDWARD⁴, ROSE ELIZA (SARAH)³ WADHAM, WILLIAM², JEREMIAH¹*) was born Jun 1890 in Clifton Hill, Victoria, Australia, and died 30 Nov 1951 in Dandenong, Victoria. He married FLORENCE MAY LIGHT 1922 in Victoria, Australia. She was born 1895 in Natimuk, Victoria, Australia, and died 1971 in Cheltenham, Victoria, Australia.

Children of HORACE BARR and FLORENCE LIGHT are:

- i. RONALD LINDSAY⁷ BARR, b. 17 Aug 1922, Lang Lang, Victoria, Australia; d. 08 Dec 1980, Victoria, Australia; m. JUNE FLORENCE GROVE; b. 05 Feb 1949; d. 30 Nov 2014.
- ii. FLORA MAY BARR, b. 1924, Lang Lang, Victoria, Australia; d. 25 Oct 1975, Black Rock, Victoria, Australia; m. DONALD ALEXANDER MCDONALD; d. Abt. Jun 1945.
- iii. ? BARR.

37. GEORGE CARLYLE⁶ AFFLECK (*ISABELLA⁵ HALDSWORTH, WILLIAM EDWARD⁴, ROSE ELIZA (SARAH)³ WADHAM, WILLIAM², JEREMIAH¹*) was born 23 May 1905 in Prahran, Victoria, Australia, and died 1973 in Heidelberg, Victoria, Australia. He married (1) JANE ADDISON. She was born 1903, and died 1958 in Yallourn, Victoria, Australia. He married (2) OLIVE MUIR. She died 1985 in Victoria, Australia.

Child of GEORGE AFFLECK and JANE ADDISON is:

- i. IAN CARLYLE⁷ AFFLECK, b. 26 Sep 1942, Jessie McPherson hospital, Victoria, Australia; m. BARBARA MARY ?.

38. ISABELLA MARY⁶ FRANCIS (*SUSAN ELLEN (NELLIE)⁵ HALDSWORTH, WILLIAM EDWARD⁴, ROSE ELIZA (SARAH)³ WADHAM, WILLIAM², JEREMIAH¹*) was born 26 Sep 1904 in Granville, NSW, Australia, and died 27 Feb 1987 in Camden, New South Wales, Australia. She married FREDERICK BEAMES 18 Jun 1925 in Granville, NSW, Australia, son of GEORGE BEAMES and HARRIETT PEARSON. He was born 28 Jan 1902 in Newtown, NSW, Australia, and died 17 Sep 1969 in Granville, NSW, Australia.

Children of ISABELLA FRANCIS and FREDERICK BEAMES are:

- i. NEALE FREDERICK⁷ BEAMES, b. 19 Sep 1926, Granville, NSW, Australia; d. 10 Mar 2010, Byron Bay, New South Wales, Australia; m. (1) JOY ROSE MCINTYRE; m. (2) MAUREEN PEARSON STEWART, 1957, Burwood, New South Wales, Australia; b. 13 Jan 1927; d. 19 Apr 2011, Byron Bay, New South Wales, Australia.
50. ii. NANCY BEAMES, b. 29 May 1931, Sydney, New South Wales, Australia; d. 30 May 2003, Berry, New South Wales, Australia.

39. CHARLES EDWARD⁶ FRANCIS (*SUSAN ELLEN (NELLIE)⁵ HALDSWORTH, WILLIAM EDWARD⁴, ROSE ELIZA (SARAH)³ WADHAM, WILLIAM², JEREMIAH¹*) was born 31 Dec 1905 in Granville, NSW, Australia, and died 21 Nov 1978 in Sunnybank, Queensland, Australia. He married MAUD BLACKEBY. She was born 16 Jan 1911 in Sydney, New South Wales, Australia, and died in Sunnybank, Queensland, Australia.

Children of CHARLES FRANCIS and MAUD BLACKEBY are:

- i. ANNE⁷ FRANCIS.
- ii. LEIGH FRANCIS.
- iii. ? FRANCIS.

40. GRACE EVELYN⁶ FRANCIS (*SUSAN ELLEN (NELLIE)⁵ HALDSWORTH, WILLIAM EDWARD⁴, ROSE ELIZA (SARAH)³ WADHAM, WILLIAM², JEREMIAH¹*) was born 11 Nov 1918 in Granville, NSW, Australia, and died 04 May 1998 in Epping, New South Wales, Australia. She married REGINALD CHARLES DENNY. He was born Abt. 1922, and died 22 Feb 2010 in Norwest Private Hospital, New South Wales, Australia.

Child of GRACE FRANCIS and REGINALD DENNY is:

- i. ?⁷ DENNY.

41. GEORGE WILLIAM⁶ FRANCIS (*SUSAN ELLEN (NELLIE)⁵ HALDSWORTH, WILLIAM EDWARD⁴, ROSE ELIZA (SARAH)³ WADHAM, WILLIAM², JEREMIAH¹*) was born 25 Feb 1914 in Granville, NSW, Australia, and died 31 Aug 1990 in North Parramatta, NSW, Australia. He married DOROTHY EASTON WALSHE. She was born Abt. 1918, and died 07 Oct 1991 in North Parramatta, NSW, Australia.

Child of GEORGE FRANCIS and DOROTHY WALSHE is:

- i. ?⁷ FRANCIS.

42. ERNEST⁶ SEARS (*JAMES ALBERT⁵, JAMES CHUTER (TUDOR)⁴, ROSE ELIZA (SARAH)³ WADHAM, WILLIAM², JEREMIAH¹*) was born 19 Mar 1946, and died 06 Jun 1999. He married ISOBEL MAUDE HYMUS, daughter of MARGARET AMELIA MCCONKEY. She was born 21 Nov 1911, and died 03 Feb 1991.

Child of ERNEST SEARS and ISOBEL HYMUS is:

51. i. ?⁷ SEARS.

43. ALBERT HENRY SEARS⁶ FLINN (*EMILY SARAH⁵ SEARS, JAMES CHUTER (TUDOR)⁴, ROSE ELIZA (SARAH)³ WADHAM, WILLIAM², JEREMIAH¹*) was born 17 May 1894 in Carlton, Victoria, and died 07 Oct 1986 in Hollywood, Western Australia. He married ELIZABETH GARDNER 28 Oct 1918 in Stirlingshire County, Scotland. She was born 1894.

Child of ALBERT FLINN and ELIZABETH GARDNER is:

52. i. KENNETH⁷ SEARS.

Generation No. 7

44. EDWIN (EDDIE) LISTER⁷ HANDRICKS (*RUBY FRANCES⁶ STAGGARD, ROSE-ANNE⁵ HALDSWORTH, WILLIAM EDWARD⁴, ROSE ELIZA (SARAH)³ WADHAM, WILLIAM², JEREMIAH¹*) was born 05 Mar 1926 in Lister Hospital, Riverside Road, Gisborne, and died 01 May 2011 in Middlemore Hospital, Auckland. He married NORMA MARGARET LOUISA HARRIS 31 Oct 1953 in 2:00pm St Davids Church, Naenae, Wellington, daughter of FREDERICK HARRIS and MARGARET VALENTINE. She was born 12 Jan 1930 in Alexandra Nursing Home, 28 Hanson Street, Newtown, Wellington, and died 11 Dec 2011 in St Andrews Hospital, Glendowie, Auckland.

Children of EDWIN HANDRICKS and NORMA HARRIS are:

53. i. IAN LISTER⁸ HANDRICKS, b. 06 Jul 1955, At Home, 9 Farringdon St, Glen Innes, Auckland.
54. ii. LYNETTE MARGARET HANDRICKS, b. 02 Jul 1957, At Home, 9 Farringdon St, Glen Innes, Auckland.
55. iii. GLENN PETER HANDRICKS, b. 03 Mar 1966, Middlemore Hospital, Auckland.

45. ROBERT HARRY⁷ HANDRICKS (*RUBY FRANCES⁶ STAGGARD, ROSE-ANNE⁵ HALDSWORTH, WILLIAM EDWARD⁴, ROSE ELIZA (SARAH)³ WADHAM, WILLIAM², JEREMIAH¹*) was born 08 Apr 1920 in Gisborne, and died 07 Aug 2007 in Dargaville. He married KATHLEEN GLADYS MAY HOWELLS 1956, daughter of STEPHEN HOWELLS and MAUD YOUNG. She was born 27 Jun 1927 in NZ, and died 19 Oct 1989 in Auckland.

Children of ROBERT HANDRICKS and KATHLEEN HOWELLS are:

56. i. LINDA MAY⁸ HANDRICKS, b. 11 Sep 1962.
- ii. DIANE FRANCES HANDRICKS, b. 02 May 1960; m. LIONEL LOZA.

46. NORMAN LESLIE⁷ HANDRICKS (*RUBY FRANCES⁶ STAGGARD, ROSE-ANNE⁵ HALDSWORTH, WILLIAM EDWARD⁴, ROSE ELIZA (SARAH)³ WADHAM, WILLIAM², JEREMIAH¹*) was born 19 Sep 1915 in Wellington, and died 27 Jan 2004 in Whakatane. He married PEGGY DOREEN MOSEN 1943, daughter of JAMES MOSEN and BEATRICE BOWLES. She was born 17 Apr 1923 in Masterton, and died 30 Jun 2014 in Whakatane.

Children of NORMAN HANDRICKS and PEGGY MOSEN are:

57. i. PAUL⁸ HANDRICKS, b. 23 Mar 1944, Masterton.
- ii. SHIRLEY HANDRICKS, b. 30 Jan 1959.

47. DOUGLAS HUBERT NELSON⁷ HANDRICKS (*RUBY FRANCES⁶ STAGGARD, ROSE-ANNE⁵ HALDSWORTH, WILLIAM EDWARD⁴, ROSE ELIZA (SARAH)³ WADHAM, WILLIAM², JEREMIAH¹*) was born 25 Aug 1917 in Nelson, and died 09 May 1981 in Sydney. He met (1) MAUVA BERYL CLEMENTS 1940, daughter of EDGAR CLEMENTS and VIOLET CLARIDGE. She was born 22 Jul 1921 in Nelson, New Zealand, and died Jul 1968 in Akron NY USA. He married (2) FREDA BARBARA SPILSBURY 1946 in New Zealand, daughter of JOHN SPILSBURY and EDNA THORNE. She was born 03 Apr 1922 in St Helens Hospital, Auckland, New Zealand, and died Mar 1989 in Sydney, New South Wales, Australia.

Children of DOUGLAS HANDRICKS and MAUVA CLEMENTS are:

58. i. YVONNE IRENE⁸ HANDRICKS, b. 29 Dec 1940, Auckland.
- ii. ? HANDRICKS, b. 29 Dec 1940, Auckland; d. 29 Dec 1940, Auckland.

48. PERCIVAL SAMUEL⁷ BRADFORD (*BERTHA BEATRICE GERTRUDE⁶ BARR, MARGARET⁵ HALDSWORTH, WILLIAM EDWARD⁴, ROSE ELIZA (SARAH)³ WADHAM, WILLIAM², JEREMIAH¹*) was born 15 Jan 1906 in Whittlesea, Victoria, Australia, and died 30 Nov 1967 in Terang, Victoria, Australia. He married DOROTHY ALMA RUSSELL. She was born 1911, and died 02 Sep 1982 in Warrnambool, Victoria, Australia.

Children of PERCIVAL BRADFORD and DOROTHY RUSSELL are:

- i. NORMA MARGARET⁸ BRADFORD, b. 06 Jan 1935, Terang, Victoria, Australia; d. 05 Nov 1991, Warrnambool, Victoria, Australia; m. REGINALD JOHN WALTERS; b. 08 Jul 1932, Terang, Victoria, Australia; d. 22 Mar 2005, Melbourne, Victoria, Australia.
- ii. BETTY BRADFORD, d. May 1991.
- iii. VALMA BRADFORD.
- iv. EDWARD (EDDIE) BRADFORD, d. Jun 1990, Warrnambool, Victoria, Australia.
- v. ALLAN PERCIVAL BRADFORD.

49. ETHEL ISABELLA MARY⁷ BRADFORD (*BERTHA BEATRICE GERTRUDE⁶ BARR, MARGARET⁵ HALDSWORTH, WILLIAM EDWARD⁴, ROSE ELIZA (SARAH)³ WADHAM, WILLIAM², JEREMIAH¹*) was born 21 Mar 1909 in Whittlesea, Victoria, Australia. She married SAMPSON ROGER BENNETT. He was born 1886, and died 01 Jan 1960 in Daylesford, Victoria.

Children of ETHEL BRADFORD and SAMPSON BENNETT are:

- i. ROGER HOLLOWAY⁸ BENNETT, b. 1930; d. 1964, Ballarat, Victoria.
- ii. DAWN BENNETT, b. 1934; d. 2014.
- iii. IAN BENNETT.
- iv. KEITH LINTON BENNETT.

50. NANCY⁷ BEAMES (*ISABELLA MARY⁶ FRANCIS, SUSAN ELLEN (NELLIE)⁵ HALDSWORTH, WILLIAM EDWARD⁴, ROSE ELIZA (SARAH)³ WADHAM, WILLIAM², JEREMIAH¹*) was born 29 May 1931 in Sydney, New South Wales, Australia, and died 30 May 2003 in Berry, New South Wales, Australia. She married ? STEWART.

Children of NANCY BEAMES and ? STEWART are:

- i. ?⁸ STEWART.
- ii. ? STEWART.

51. ?⁷ SEARS (*ERNEST⁶, JAMES ALBERT⁵, JAMES CHUTER (TUDOR)⁴, ROSE ELIZA (SARAH)³ WADHAM, WILLIAM², JEREMIAH¹*) She married ? STEVENS, son of SIDNEY STEVENS and ETHEL PRATT.

Children of ? SEARS and ? STEVENS are:

- i. ANDREW JOHN⁸ STEVENS, b. 1967; d. 06 May 1969, Perth, Western Australia, Australia.
- ii. ? STEVENS.
- iii. ? STEVENS.
- iv. ? STEVENS.
- v. ? STEVENS.

52. KENNETH⁷ SEARS (*ALBERT HENRY SEARS⁶ FLINN, EMILY SARAH⁵ SEARS, JAMES CHUTER (TUDOR)⁴, ROSE ELIZA (SARAH)³ WADHAM, WILLIAM², JEREMIAH¹*)

Child of KENNETH SEARS is:

- i. MALCOLM⁸ SEARS.

Generation No. 8

53. IAN LISTER⁸ HANDRICKS (*EDWIN (EDDIE) LISTER⁷, RUBY FRANCES⁶ STAGGARD, ROSE-ANNE⁵ HALDSWORTH, WILLIAM EDWARD⁴, ROSE ELIZA (SARAH)³ WADHAM, WILLIAM², JEREMIAH¹*) was born 06 Jul 1955 in At Home, 9 Farringdon St, Glen Innes, Auckland. He married JOCELYN RUTH BROWN 11 Feb 1978 in Holy Trinity Anglican Church, Dargaville, daughter of OWEN BROWN and ROMA SIMONS. She was born 16 Dec 1954 in Te Kopuru.

Notes for JOCELYN RUTH BROWN:

Jocelyn was born at the Annex, Te Kopuru Hospital near Dargaville. She grew up on the family farm at Waihue. Her mother encouraged her to learn Scottish Dancing for which she received many awards. Jocelyn attended ATi where she gained qualifications as an office assistant and worked for Consumers Institute.

Children of IAN HANDRICKS and JOCELYN BROWN are:

- i. DANIEL LOGAN⁹ HANDRICKS, b. 20 May 1981, National Women's Hospital, Auckland; d. 08 May 2017, 40 Grant Ave, Hope Island, Gold Coast, Queensland, Australia.
- ii. HELEN RUBY HANDRICKS, b. 31 Oct 1983, John Radcliffe Hospital, Oxford, England; m. RICHARD GLEW, 03 Jan 2020, Australia.
- iii. ÉLOÏSE ADÈLE HANDRICKS, b. 11 Oct 1985, John Radcliffe Hospital, Oxford, England; m. ANTON GILBERT, 03 Oct 2020, Brisbane, Australia.

54. LYNETTE MARGARET⁸ HANDRICKS (*EDWIN (EDDIE) LISTER⁷, RUBY FRANCES⁶ STAGGARD, ROSE-ANNE⁵ HALDSWORTH, WILLIAM EDWARD⁴, ROSE ELIZA (SARAH)³ WADHAM, WILLIAM², JEREMIAH¹*) was born 02 Jul 1957 in At Home, 9 Farringdon St, Glen Innes, Auckland. She married SIANG HUAT OOI 25 Mar 1978 in Auckland, son of HOI OOI and SAW PHAN. He was born 30 Nov 1952 in Malaysia.

Children of LYNETTE HANDRICKS and SIANG OOI are:

- i. LISA MARGARET⁹ OOI, b. 20 Oct 1981.
59. ii. FIONA MAY OOI, b. 22 Mar 1984, Auckland.
- iii. ROBYN JANE OOI, b. 31 Dec 1987.

55. GLENN PETER⁸ HANDRICKS (*EDWIN (EDDIE) LISTER⁷, RUBY FRANCES⁶ STAGGARD, ROSE-ANNE⁵ HALDSWORTH, WILLIAM EDWARD⁴, ROSE ELIZA (SARAH)³ WADHAM, WILLIAM², JEREMIAH¹*) was born 03 Mar 1966 in Middlemore Hospital, Auckland. He married (1) JUNE ELIZABETH DAVISON 12 Sep 1987 in Auckland, daughter of ROY BRINK and MARJORIE PAPE. She was born 06 Mar 1966 in Australia. He married (2) FAY LUCINDA WILKINSON 13 Jul 2019 in Sandy Creek, Queensland, daughter of ROBERT WILKINSON and LEILA SANDERS. She was born 04 Mar 1965 in Horsham, Victoria.

Children of GLENN HANDRICKS and JUNE DAVISON are:

- i. KIMBERLEY MARIE⁹ HANDRICKS, b. 15 Jul 1995, Auckland.
- ii. KELLIE JUNE HANDRICKS, b. 15 Mar 1998, Auckland.

56. LINDA MAY⁸ HANDRICKS (*ROBERT HARRY⁷, RUBY FRANCES⁶ STAGGARD, ROSE-ANNE⁵ HALDSWORTH, WILLIAM EDWARD⁴, ROSE ELIZA (SARAH)³ WADHAM, WILLIAM², JEREMIAH¹*) was born 11 Sep 1962. She married RAYMOND JOHN MCLEAN 16 Sep 1987. He was born 12 Sep 1962.

Children of LINDA HANDRICKS and RAYMOND MCLEAN are:

- i. CHARLOTTE (CHARLIE) MAY⁹ MCLEAN, b. 15 Mar 1987.
- ii. MAX CHRISTIAN MCLEAN, b. 08 Sep 1988.

57. PAUL⁸ HANDRICKS (*NORMAN LESLIE⁷, RUBY FRANCES⁶ STAGGARD, ROSE-ANNE⁵ HALDSWORTH, WILLIAM EDWARD⁴, ROSE ELIZA (SARAH)³ WADHAM, WILLIAM², JEREMIAH¹*) was born 23 Mar 1944 in Masterton. He married VICKI ASHTON CHATFIELD 11 Jan 1966 in Gisborne, daughter of KEITH CHATFIELD and PIKI MORRELL. She was born 12 Jun 1948 in Opotiki.

Children of PAUL HANDRICKS and VICKI CHATFIELD are:

60. i. PAUL KEITH NORMAN⁹ HANDRICKS, b. 18 Aug 1967, Opotiki.
61. ii. LISA-JANE HANDRICKS, b. 26 Jul 1969, Opotiki.
- iii. LEIGH-ANNE HANDRICKS, b. 20 Jul 1966, Opotiki.
62. iv. JOANNE ASHTON HANDRICKS, b. 27 Jun 1970, Gisborne.

58. YVONNE IRENE⁸ HANDRICKS (*DOUGLAS HUBERT NELSON⁷, RUBY FRANCES⁶ STAGGARD, ROSE-ANNE⁵ HALDSWORTH, WILLIAM EDWARD⁴, ROSE ELIZA (SARAH)³ WADHAM, WILLIAM², JEREMIAH¹*) was born 29 Dec 1940 in Auckland. She married (1) ROBERT NORMAN FOGAL Abt. 1957 in Akron New York, son of GEORGE FOGAL and FLORENCE STIBBS. He was born 19 Oct 1931 in on the family farm, Akron, New York. She married (2) LEON FOSTER ROWIN 26 Feb 1966 in Los Angeles, son of ROLLIE ROWIN and ETHEL VAN DUZEE. He was born 19 Aug 1938.

Children of YVONNE HANDRICKS and ROBERT FOGAL are:

- i. WADE EDWARD⁹ FOGAL, b. 22 Sep 1957, California.
63. ii. VICTORIA LYNNE FOGAL, b. 04 Oct 1958, California.
64. iii. RAYMIE PAUL FOGAL, b. 04 Apr 1961, Hawthorne, Ca.

Child of YVONNE HANDRICKS and LEON ROWIN is:

65. iv. STEVEN LEE⁹ ROWIN, b. 09 Oct 1966, California.

Generation No. 9

59. FIONA MAY⁹ OOI (*LYNETTE MARGARET⁸ HANDRICKS, EDWIN (EDDIE) LISTER⁷, RUBY FRANCES⁶ STAGGARD, ROSE-ANNE⁵ HALDSWORTH, WILLIAM EDWARD⁴, ROSE ELIZA (SARAH)³ WADHAM, WILLIAM², JEREMIAH¹*) was born 22 Mar 1984 in Auckland. She married ANTONIO MASTELLONE 19 Oct 2014 in Massa Lubrense, Italy.

Child of FIONA OOI and ANTONIO MASTELLONE is:

- i. SILVANA¹⁰ MASTELLONE, b. 05 Jan 2016, Italy.

60. PAUL KEITH NORMAN⁹ HANDRICKS (*PAUL⁸, NORMAN LESLIE⁷, RUBY FRANCES⁶ STAGGARD, ROSE-ANNE⁵ HALDSWORTH, WILLIAM EDWARD⁴, ROSE ELIZA (SARAH)³ WADHAM, WILLIAM², JEREMIAH¹*) was born 18 Aug 1967 in Opotiki. He married (1) KAREN GALLY. He married (2) LINDA REECE, daughter of DAVID REECE and NORMA GOODSPEED. He married (3) OLIVIA BAYLISS.

Children of PAUL HANDRICKS and KAREN GALLY are:

- i. BENJAMIN¹⁰ HANDRICKS, b. 01 Jan 1992.
- ii. KELVIN HANDRICKS, b. 02 Apr 1993.

Child of PAUL HANDRICKS and LINDA REECE is:

- iii. DEVON NORMAN¹⁰ REECE, b. 17 Sep 1999.

Children of PAUL HANDRICKS and OLIVIA BAYLISS are:

- iv. LEVI JOSEF¹⁰ BAYLISS-HANDRICKS, b. 08 Jan 2020, Wellington.
- v. HAZEL BAYLISS-HANDRICKS, b. Aug 2021, Raumati.

61. LISA-JANE⁹ HANDRICKS (*PAUL⁸, NORMAN LESLIE⁷, RUBY FRANCES⁶ STAGGARD, ROSE-ANNE⁵ HALDSWORTH, WILLIAM EDWARD⁴, ROSE ELIZA (SARAH)³ WADHAM, WILLIAM², JEREMIAH¹*) was born 26 Jul 1969 in Opotiki. She met CARL PHILPOTT. He was born 13 Jul 1972 in Auckland.

Children of LISA-JANE HANDRICKS and CARL PHILPOTT are:

- i. FLETCHER NORMAN¹⁰ PHILPOTT, b. 14 Feb 2004, Whakatane.
- ii. SPENCER HENRI PHILPOTT, b. 23 Sep 2005, Whakatane.

62. JOANNE ASHTON⁹ HANDRICKS (*PAUL⁸, NORMAN LESLIE⁷, RUBY FRANCES⁶ STAGGARD, ROSE-ANNE⁵ HALDSWORTH, WILLIAM EDWARD⁴, ROSE ELIZA (SARAH)³ WADHAM, WILLIAM², JEREMIAH¹*) was born 27 Jun 1970 in Gisborne. She married PAUL ELSOM 17 Mar 2003 in Snells Beach. He was born Nov in Auckland.

Child of JOANNE HANDRICKS and PAUL ELSOM is:

- i. TOBY ASHTON¹⁰ ELSOM, b. 14 Jul 2004.

63. VICTORIA LYNNE⁹ FOGAL (*YVONNE IRENE⁸ HANDRICKS, DOUGLAS HUBERT NELSON⁷, RUBY FRANCES⁶ STAGGARD, ROSE-ANNE⁵ HALDSWORTH, WILLIAM EDWARD⁴, ROSE ELIZA (SARAH)³ WADHAM, WILLIAM², JEREMIAH¹*) was born 04 Oct 1958 in California. She married (1) STEPHEN ROCKER 1977. She married (2) RONALD PATTERSON 1987.

Child of VICTORIA FOGAL and STEPHEN ROCKER is:

66. i. SHANON¹⁰ ROCKER, b. 24 Aug 1977.

Children of VICTORIA FOGAL and RONALD PATTERSON are:

67. ii. JUANNE¹⁰ PATTERSON.
- iii. KIRSTY PATTERSON, b. 1990, Torrance, CA.
- iv. COURTNEY PATTERSON.

64. RAYMIE PAUL⁹ FOGAL (*YVONNE IRENE⁸ HANDRICKS, DOUGLAS HUBERT NELSON⁷, RUBY FRANCES⁶ STAGGARD, ROSE-ANNE⁵ HALDSWORTH, WILLIAM EDWARD⁴, ROSE ELIZA (SARAH)³ WADHAM, WILLIAM², JEREMIAH¹*) was born 04 Apr 1961 in Hawthorne, Ca. He met (1) SHERYL MATTHEWS. He married (2) SHAUNA LORRAINE MCAFEE 03 Mar 1989. She was born 26 May 1966 in Red Deer, Alberta.

Child of RAYMIE FOGAL and SHERYL MATTHEWS is:

- i. ROBERT BURTON¹⁰ FOGAL, b. 05 Jun 1987.

Child of RAYMIE FOGAL and SHAUNA MCAFEE is:

- ii. RYAN TERRY¹⁰ FOGAL, b. 31 Dec 1998, California.

65. STEVEN LEE⁹ ROWIN (*YVONNE IRENE⁸ HANDRICKS, DOUGLAS HUBERT NELSON⁷, RUBY FRANCES⁶ STAGGARD, ROSE-ANNE⁵ HALDSWORTH, WILLIAM EDWARD⁴, ROSE ELIZA (SARAH)³ WADHAM, WILLIAM², JEREMIAH¹*) was born 09 Oct 1966 in California.

Child of STEVEN LEE ROWIN is:

- i. ASHLEE¹⁰ ROWIN.

Generation No. 10

66. SHANON¹⁰ ROCKER (*VICTORIA LYNNE⁹ FOGAL, YVONNE IRENE⁸ HANDRICKS, DOUGLAS HUBERT NELSON⁷, RUBY FRANCES⁶ STAGGARD, ROSE-ANNE⁵ HALDSWORTH, WILLIAM EDWARD⁴, ROSE ELIZA (SARAH)³ WADHAM, WILLIAM², JEREMIAH¹*) was born 24 Aug 1977. She married TIMOTHY ?.

Child of SHANON ROCKER and TIMOTHY ? is:

- i. ?¹¹ ?.

67. JUANNE¹⁰ PATTERSON (*VICTORIA LYNNE⁹ FOGAL, YVONNE IRENE⁸ HANDRICKS, DOUGLAS HUBERT NELSON⁷, RUBY FRANCES⁶ STAGGARD, ROSE-ANNE⁵ HALDSWORTH, WILLIAM EDWARD⁴, ROSE ELIZA (SARAH)³ WADHAM, WILLIAM², JEREMIAH¹*) She married RICHARD MILLER.

Child of JUANNE PATTERSON and RICHARD MILLER is:

- i. ?¹¹ MILLER.

Descendants of William Harris

Generation No. 1

1. WILLIAM¹ HARRIS was born Abt. 1648. He married MARGARET ?.

Child of WILLIAM HARRIS and MARGARET ? is:

2. i. WILLIAM² HARRIS, b. 1675, Sussex, England.

Generation No. 2

2. WILLIAM² HARRIS (*WILLIAM*¹) was born 1675 in Sussex, England. He married ELIZABETH LOCK 01 Nov 1701 in Wiltshire, England. She was born 1675 in Somerset, England.

Child of WILLIAM HARRIS and ELIZABETH LOCK is:

3. i. RICHARD³ HARRIS, b. 1702, Uckfield, Sussex, England; d. Abt. 1769.

Generation No. 3

3. RICHARD³ HARRIS (*WILLIAM*², *WILLIAM*¹) was born 1702 in Uckfield, Sussex, England, and died Abt. 1769. He married MARY HOWELL 06 Apr 1729 in Lewes, Sussex, England, daughter of JOHN HOWELL and ELIZABETH BAKER. She was born 17 Oct 1708 in Lewes, Sussex, England, and died Jul 1762.

Child of RICHARD HARRIS and MARY HOWELL is:

4. i. RICHARD⁴ HARRIS, b. 25 Mar 1730, Ringmer, Sussex, England; d. 1800, Hurstpierpoint, Sussex, England.

Generation No. 4

4. RICHARD⁴ HARRIS (*RICHARD*³, *WILLIAM*², *WILLIAM*¹) was born 25 Mar 1730 in Ringmer, Sussex, England, and died 1800 in Hurstpierpoint, Sussex, England. He married ANNE KNELLER 07 Apr 1751 in Rodmell, Sussex, England. She was born Abt. 1730.

Children of RICHARD HARRIS and ANNE KNELLER are:

5. i. EDWARD⁵ HARRIS, b. 14 Mar 1764, Rodmell, Sussex, England; d. Abt. 1837, Rodmell, Sussex, England.
- ii. RICHARD HARRIS, b. 11 Feb 1753, Rodmell, Sussex, England.
- iii. RICHARD HARRIS, b. 19 Dec 1756, Rodmell, Sussex, England.

Generation No. 5

5. EDWARD⁵ HARRIS (*RICHARD*⁴, *RICHARD*³, *WILLIAM*², *WILLIAM*¹) was born 14 Mar 1764 in Rodmell, Sussex, England, and died Abt. 1837 in Rodmell, Sussex, England. He married HANNAH SKINNER, daughter of WILLIAM SKINNER and MARY ?. She was born Abt. 1766 in Sussex, England, and died 1840 in Lewes, Sussex, England.

Children of EDWARD HARRIS and HANNAH SKINNER are:

6. i. JOHN FRANCIS⁶ HARRIS, b. 09 Jun 1792, Rodmell, Sussex, England.
- ii. ELIZABETH HARRIS, b. 02 Jul 1788, Rodmell, Sussex, England; d. 08 Jul 1788, Rodmell, Sussex, England.
7. iii. CHARLOTTE HARRIS, b. 25 Oct 1789, Rodmell, Sussex, England.
8. iv. EDWARD HARRIS, b. 09 Oct 1794, Rodmell, Sussex, England; d. Dec 1858, East Sussex, United Kingdom.
- v. RICHARD HARRIS, b. 05 Aug 1798, Rodmell, Sussex, England.
- vi. WILLIAM HARRIS, b. 19 Oct 1800, Rodmell, Sussex, England.

Generation No. 6

6. JOHN FRANCIS⁶ HARRIS (*EDWARD⁵, RICHARD⁴, RICHARD³, WILLIAM², WILLIAM¹*) was born 09 Jun 1792 in Rodmell, Sussex, England. He married ELIZABETH SARAH STANDEN 02 May 1837 in Saint Mary Magdalen, Richmond, Surrey, England. She was born Abt. 1790 in Eastbourne, Sussex, England.

Children of JOHN HARRIS and ELIZABETH STANDEN are:

9. i. JOHN STANDEN⁷ HARRIS, b. Abt. 1821, Lewes, Sussex, England; d. Mar 1880, Islington, Greater London, London, Middlesex.
- ii. ELIZABETH HARRIS, b. Abt. 1821.

7. CHARLOTTE⁶ HARRIS (*EDWARD⁵, RICHARD⁴, RICHARD³, WILLIAM², WILLIAM¹*) was born 25 Oct 1789 in Rodmell, Sussex, England. She married THOMAS HUGH PRESNELL. He was born 1782.

Child of CHARLOTTE HARRIS and THOMAS PRESNELL is:

10. i. MARY⁷ PRESNELL, b. Abt. 1813, Piddinghoe, Sussex, England; d. 1871.

8. EDWARD⁶ HARRIS (*EDWARD⁵, RICHARD⁴, RICHARD³, WILLIAM², WILLIAM¹*) was born 09 Oct 1794 in Rodmell, Sussex, England, and died Dec 1858 in East Sussex, United Kingdom. He married ELIZABETH ARNOLD 11 Sep 1826 in Brighton, Sussex, England. She was born Abt. 1795 in Chichester, Sussex, England.

Child of EDWARD HARRIS and ELIZABETH ARNOLD is:

- i. RUTH⁷ HARRIS, b. Abt. 1837, Lewes, Sussex, England; m. WILLIAM WELLS; b. Abt. 1836, Lewes, Sussex, England.

Generation No. 7

9. JOHN STANDEN⁷ HARRIS (*JOHN FRANCIS⁶, EDWARD⁵, RICHARD⁴, RICHARD³, WILLIAM², WILLIAM¹*) was born Abt. 1821 in Lewes, Sussex, England, and died Mar 1880 in Islington, Greater London, London, Middlesex. He married ANNA MARIA STREATER Abt. Sep 1851 in St George Hanover Square RD London, England, daughter of JOHN STREATER and ANNE NYE. She was born 04 Jan 1823 in Brighton, Billingshurst, Sussex, England, and died Abt. Mar 1892 in Poplar, London, England.

Children of JOHN HARRIS and ANNA STREATER are:

11. i. CHARLES STREATER⁸ HARRIS, b. 04 Aug 1860, Brighton, East London, England; d. 26 Jan 1933, England.
- ii. SARAH ELEANOR HARRIS, b. Abt. 1859, Brighton, Sussex, England.
- iii. CLARA JANE HARRIS, b. Abt. 1845, Brighton, Sussex, England; d. 1914, Poplar; m. WILLIAM STANMORE SHELL, 16 Feb 1867, Bethnal Green; b. Abt. 1845, Stratford, Essex, England; d. 1904, Stepney.
- iv. ANNA ISABELLA HARRIS, b. 05 Aug 1855, Brighton, Sussex, England.

10. MARY⁷ PRESNELL (*CHARLOTTE⁶ HARRIS, EDWARD⁵, RICHARD⁴, RICHARD³, WILLIAM², WILLIAM¹*) was born Abt. 1813 in Piddinghoe, Sussex, England, and died 1871. She married WILLIAM HILMAN 28 Jul 1833 in South Malling Sussex. He was born 09 Oct 1803 in Telscombe, Sussex, England, and died Dec 1879 in Sussex, United Kingdom.

Child of MARY PRESNELL and WILLIAM HILMAN is:

12. i. MARK⁸ HILMAN, b. 1842, Piddinghoe, Sussex, England; d. Mar 1921, Hailsham, Sussex, England.

Generation No. 8

11. CHARLES STREATER⁸ HARRIS (*JOHN STANDEN⁷, JOHN FRANCIS⁶, EDWARD⁵, RICHARD⁴, RICHARD³, WILLIAM², WILLIAM¹*) was born 04 Aug 1860 in Brighton, East London, England, and died 26 Jan 1933 in England. He married MARTHA ELIZABETH CAPPI-HUNTINGDON 15 Nov 1885 in St Paul, Old Ford, Tower Hamlets, Middlesex, daughter of CHARLES CAPPI and MARTHA WIGGINS. She was born Jun 1863 in Bethnal Green, London, England, and died Abt. Sep 1908 in Poplar, London, England.

Children of CHARLES HARRIS and MARTHA CAPPI-HUNTINGDON are:

13. i. FREDERICK JOHN⁹ HARRIS, b. 15 Jun 1896, 3 Lautrauc Rd., Stepney, London, England; d. 17 Jun 1976, Palmerston North.
14. ii. CHARLES WILLIAM HARRIS, b. Abt. 1888, Bethnal Green, London, England.
15. iii. EDWARD ERNEST HARRIS, b. Abt. 1891, Bethnal Green, London, England; d. 18 Oct 1917, Flanders, France.
15. iv. ALBERT HARRIS, b. Abt. 1890, Bow, London, England.
16. v. WALTER STREATER HARRIS, b. Mar 1889, Bethnal Green, London, England; d. 23 Nov 1916, Flanders, France.
17. vi. FLORENCE ELIZABETH HARRIS, b. 14 Dec 1900, 31 Burdett Road, London; d. Jun 1980, Gloucester.
17. vii. MARTHA CLARA HARRIS, b. 1893, Bethnal Green, London, England.
17. viii. GEORGE HARRIS, b. Abt. 1897.
17. ix. EDMUND HARRIS, b. Abt. 1892.

12. MARK⁸ HILMAN (*MARY⁷ PRESNELL, CHARLOTTE⁶ HARRIS, EDWARD⁵, RICHARD⁴, RICHARD³, WILLIAM², WILLIAM¹*) was born 1842 in Piddinghoe, Sussex, England, and died Mar 1921 in Hailsham, Sussex, England. He married SARAH THOMPSETT. She was born Abt. 1841 in Firle, Sussex, England, and died Jul 1872 in Lewes, Sussex, United Kingdom.

Children of MARK HILMAN and SARAH THOMPSETT are:

18. i. ELIZA⁹ HILMAN, b. Jun 1870, Glynde, Sussex, England; d. 14 Jul 1911, Darra, Queensland, Australia.
18. ii. LUCY A R HILMAN, b. 1866, Glynde, Sussex, England; d. Apr 1886, Portsea Island, Hampshire.

Generation No. 9

13. FREDERICK JOHN⁹ HARRIS (*CHARLES STREATER⁸, JOHN STANDEN⁷, JOHN FRANCIS⁶, EDWARD⁵, RICHARD⁴, RICHARD³, WILLIAM², WILLIAM¹*) was born 15 Jun 1896 in 3 Lautrauc Rd., Stepney, London, England, and died 17 Jun 1976 in Palmerston North. He married MARGARET MIRIAM (MAY) VALENTINE 19 Feb 1921 in The Register Office, West Ham, London England, daughter of COLEMAN VALENTINE and LOUISA HERRETT. She was born 07 Jan 1903 in Mile End Road, London, England, and died 02 Sep 1980 in Wellington.

Children of FREDERICK HARRIS and MARGARET VALENTINE are:

19. i. NORMA MARGARET LOUISA¹⁰ HARRIS, b. 12 Jan 1930, Alexandra Nursing Home, 28 Hanson Street, Newtown, Wellington; d. 11 Dec 2011, St Andrews Hospital, Glendowie, Auckland.
20. ii. FREDERICK CHARLES HARRIS, b. 07 Jul 1922, Mile End Rd, Stepney, London; d. 05 Jun 1999, 53 Fairs Rd., Palmerston North.

14. CHARLES WILLIAM⁹ HARRIS (*CHARLES STREATER⁸, JOHN STANDEN⁷, JOHN FRANCIS⁶, EDWARD⁵, RICHARD⁴, RICHARD³, WILLIAM², WILLIAM¹*) was born Abt. 1888 in Bethnal Green, London, England. He married MARGARET ALMA BUNDY 12 May 1913 in St Luke, Hackney, daughter of WILLIAM BUNDY and LIZZIE GRAYSTON. She was born 1887, and died Apr 1963.

Children of CHARLES HARRIS and MARGARET BUNDY are:

- i. LEONARD¹⁰ HARRIS, b. 1925, London, England; d. 1986; m. ? NICHOLLS.
- ii. VIOLET HARRIS, b. 1921, London, England; d. 1987.
- iii. CHARLES SAMUEL WILLIAM HARRIS, b. 04 Jul 1914, London, England; d. 1969, London, England.
- iv. DORIS HARRIS, b. 1919, London, England; d. 2002.
- v. ? HARRIS, b. London, England.

15. EDWARD ERNEST⁹ HARRIS (*CHARLES STREATER⁸, JOHN STANDEN⁷, JOHN FRANCIS⁶, EDWARD⁵, RICHARD⁴, RICHARD³, WILLIAM², WILLIAM¹*) was born Abt. 1891 in Bethnal Green, London, England, and died 18 Oct 1917 in Flanders, France. He married HELEN HOBBS 1915.

Children of EDWARD HARRIS and HELEN HOBBS are:

21. i. ?¹⁰ HARRIS, b. Aug 1917.
21. ii. ? HARRIS, b. Bef. 1917.

16. WALTER STREATER⁹ HARRIS (*CHARLES STREATER⁸, JOHN STANDEN⁷, JOHN FRANCIS⁶, EDWARD⁵, RICHARD⁴, RICHARD³, WILLIAM², WILLIAM¹*) was born Mar 1889 in Bethnal Green, London, England, and died 23 Nov 1916 in Flanders, France. He married EDITH KATE HARDY 1912.

Child of WALTER HARRIS and EDITH HARDY is:

- i. KATE¹⁰ HARRIS, b. 1914.

17. FLORENCE ELIZABETH⁹ HARRIS (*CHARLES STREATER⁸, JOHN STANDEN⁷, JOHN FRANCIS⁶, EDWARD⁵, RICHARD⁴, RICHARD³, WILLIAM², WILLIAM¹*) was born 14 Dec 1900 in 31 Burdett Road, London, and died Jun 1980 in Gloucester. She married (1) GEORGE TOWNSEND in Clacton on Sea, son of GEORGE TOWNSEND and HARRIET ENGLAND. He was born 19 Dec 1904 in Deal, Kent, and died 06 Sep 1935 in Tendring Hospital. She married (2) JOE ILES.

Children of FLORENCE HARRIS and GEORGE TOWNSEND are:

22. i. FLORENCE IRENE¹⁰ TOWNSEND, b. 12 Jan 1927, Coastguard Station, 5 Tower Rd. Clacton on Sea, Essex.
23. ii. NOREEN ELIZABETH LILIAN TOWNSEND, b. 27 Dec 1927, Clacton on Sea, Essex.
24. iii. KATHLEEN HARRIET TOWNSEND, b. 12 Aug 1931, Clacton on Sea, Essex.

Child of FLORENCE HARRIS and JOE ILES is:

- iv. DERRICK¹⁰ ILES, b. Aug 1942.

18. ELIZA⁹ HILMAN (*MARK⁸, MARY⁷ PRESNELL, CHARLOTTE⁶ HARRIS, EDWARD⁵, RICHARD⁴, RICHARD³, WILLIAM², WILLIAM¹*) was born Jun 1870 in Glynde, Sussex, England, and died 14 Jul 1911 in Darra, Queensland, Australia. She married JAMES IVES Oct 1896 in East Preston, Sussex, England. He was born 26 Sep 1864 in Lancing, Sussex, and died 22 Jul 1935 in Brisbane, Queensland, Australia.

Children of ELIZA HILMAN and JAMES IVES are:

- i. JAMES WILLIAM MARK (BILL)¹⁰ IVES, b. 26 Dec 1897, Sompting, Sussex; d. 15 Sep 1971, Brisbane, Queensland Australia.
- ii. REGINALD ARTHUR FREDRICK IVES, b. 08 Mar 1899, Sompting, Sussex; d. 30 Dec 1957, Queensland Australia.
- iii. LUCY MARGARET IVES, b. Oct 1900, Steyning, Sussex, United Kingdom.
- iv. GEORGE TOMSETT IVES, b. Jan 1904, West Blatchington, Sussex; d. 28 Dec 1978, Nerang, Queensland, Australia.
- v. ROBERT JOHN IVES, b. 05 Aug 1905, Iford, Sussex; d. 12 Feb 1982, Brisbane, Queensland Australia.
- vi. MABEL GRACE IVES, b. 02 Feb 1907, Sewell's Cottages, Sewell's Farm, Barcombe, East Sussex, England; d. 20 May 1989, Prince Charles Hospital, Chermshire, Brisbane, Queensland, Australia; m. LEONARD JAMES HOGAN; b. 05 Dec 1896; d. 11 Nov 1954.

Generation No. 10

19. NORMA MARGARET LOUISA¹⁰ HARRIS (*FREDERICK JOHN⁹, CHARLES STREATER⁸, JOHN STANDEN⁷, JOHN FRANCIS⁶, EDWARD⁵, RICHARD⁴, RICHARD³, WILLIAM², WILLIAM¹*) was born 12 Jan 1930 in Alexandra Nursing Home, 28 Hanson Street, Newtown, Wellington, and died 11 Dec 2011 in St Andrews Hospital, Glendowie, Auckland. She married EDWIN (EDDIE) LISTER HANDRICKS 31 Oct 1953 in 2:00pm St Davids Church, Naenae, Wellington, son of NORMAN HANDRICKS and RUBY STAGGARD. He was born 05 Mar 1926 in Lister Hospital, Riverside Road, Gisborne, and died 01 May 2011 in Middlemore Hospital, Auckland.

Children of NORMA HARRIS and EDWIN HANDRICKS are:

25. i. IAN LISTER¹¹ HANDRICKS, b. 06 Jul 1955, At Home, 9 Farringdon St, Glen Innes, Auckland.
26. ii. LYNETTE MARGARET HANDRICKS, b. 02 Jul 1957, At Home, 9 Farringdon St, Glen Innes, Auckland.
27. iii. GLENN PETER HANDRICKS, b. 03 Mar 1966, Middlemore Hospital, Auckland.

20. FREDERICK CHARLES¹⁰ HARRIS (*FREDERICK JOHN⁹, CHARLES STREATER⁸, JOHN STANDEN⁷, JOHN FRANCIS⁶, EDWARD⁵, RICHARD⁴, RICHARD³, WILLIAM², WILLIAM¹*) was born 07 Jul 1922 in Mile End Rd, Stepney, London, and died 05 Jun 1999 in 53 Fairs Rd., Palmerston North. He married ALDRED HELEN BROOKS 1947 in Palmerston North, daughter of HENRY BROOKS and EMILY SOWTER. She was born 15 Jul 1918 in Palmerston North, and died 09 Dec 1997 in Monrad Rest Home, 124 Monrad St, Palmerston North.

Child of FREDERICK HARRIS and ALDRED BROOKS is:

- i. VICKY MICHELLE¹¹ HARRIS, b. 10 Oct 1958, Palmerston North; m. DAVID SHACKLETON.

21. ?¹⁰ HARRIS (*EDWARD ERNEST*⁹, *CHARLES STREATER*⁸, *JOHN STANDEN*⁷, *JOHN FRANCIS*⁶, *EDWARD*⁵, *RICHARD*⁴, *RICHARD*³, *WILLIAM*², *WILLIAM*¹) was born Aug 1917.

Child of ? HARRIS is:

- i. MAUREEN¹¹ HARRIS, m. ? GAYNOR.

22. FLORENCE IRENE¹⁰ TOWNSEND (*FLORENCE ELIZABETH*⁹ HARRIS, *CHARLES STREATER*⁸, *JOHN STANDEN*⁷, *JOHN FRANCIS*⁶, *EDWARD*⁵, *RICHARD*⁴, *RICHARD*³, *WILLIAM*², *WILLIAM*¹) was born 12 Jan 1927 in Coastguard Station, 5 Tower Rd. Clacton on Sea, Essex. She married GEORGE GIBSON 03 May 1947 in Registry Office Kidderminster Worcs, son of MATHEW GIBSON and ELEANOR LONGMIRE. He was born 29 Nov 1914 in Kendal.

Children of FLORENCE TOWNSEND and GEORGE GIBSON are:

- i. CHARLES HENRY¹¹ GIBSON, b. 01 Apr 1953, Kidderminster Worcs.
28. ii. PAMELA MARY GIBSON, b. 29 Dec 1954, Kidderminster Worcs.
29. iii. BARBARA DENISE GIBSON, b. 22 Mar 1957, Kidderminster Worcs.
30. iv. YVONNE MARGARET GIBSON, b. 01 Dec 1958, Kidderminster Worcs.

23. NOREEN ELIZABETH LILIAN¹⁰ TOWNSEND (*FLORENCE ELIZABETH*⁹ HARRIS, *CHARLES STREATER*⁸, *JOHN STANDEN*⁷, *JOHN FRANCIS*⁶, *EDWARD*⁵, *RICHARD*⁴, *RICHARD*³, *WILLIAM*², *WILLIAM*¹) was born 27 Dec 1927 in Clacton on Sea, Essex. She married STEPHEN HOWARD. He died 2000.

Child of NOREEN TOWNSEND and STEPHEN HOWARD is:

- i. STEPHANIE¹¹ HOWARD, b. 01 Jan 1956.

24. KATHLEEN HARRIET¹⁰ TOWNSEND (*FLORENCE ELIZABETH*⁹ HARRIS, *CHARLES STREATER*⁸, *JOHN STANDEN*⁷, *JOHN FRANCIS*⁶, *EDWARD*⁵, *RICHARD*⁴, *RICHARD*³, *WILLIAM*², *WILLIAM*¹) was born 12 Aug 1931 in Clacton on Sea, Essex. She married LESLIE WOOD in Gloucester. He was born 1920.

Children of KATHLEEN TOWNSEND and LESLIE WOOD are:

- i. PENELOPE¹¹ WOOD.
- ii. JACQUELINE WOOD.
- iii. CAROL WOOD.

Generation No. 11

25. IAN LISTER¹¹ HANDRICKS (*NORMA MARGARET LOUISA*¹⁰ HARRIS, *FREDERICK JOHN*⁹, *CHARLES STREATER*⁸, *JOHN STANDEN*⁷, *JOHN FRANCIS*⁶, *EDWARD*⁵, *RICHARD*⁴, *RICHARD*³, *WILLIAM*², *WILLIAM*¹) was born 06 Jul 1955 in At Home, 9 Farringdon St, Glen Innes, Auckland. He married JOCELYN RUTH BROWN 11 Feb 1978 in Holy Trinity Anglican Church, Dargaville, daughter of OWEN BROWN and ROMA SIMONS. She was born 16 Dec 1954 in Te Kopuru.

Children of IAN HANDRICKS and JOCELYN BROWN are:

- i. DANIEL LOGAN¹² HANDRICKS, b. 20 May 1981, National Women's Hospital, Auckland; d. 08 May 2017, 40 Grant Ave, Hope Island, Gold Coast, Queensland, Australia.
- ii. HELEN RUBY HANDRICKS, b. 31 Oct 1983, John Radcliffe Hospital, Oxford, England; m. RICHARD GLEW, 03 Jan 2020, Australia.
- iii. ÉLOÏSE ADÈLE HANDRICKS, b. 11 Oct 1985, John Radcliffe Hospital, Oxford, England; m. ANTON GILBERT, 03 Oct 2020, Brisbane, Australia.

26. LYNETTE MARGARET¹¹ HANDRICKS (*NORMA MARGARET LOUISA¹⁰ HARRIS, FREDERICK JOHN⁹, CHARLES STREATER⁸, JOHN STANDEN⁷, JOHN FRANCIS⁶, EDWARD⁵, RICHARD⁴, RICHARD³, WILLIAM², WILLIAM¹*) was born 02 Jul 1957 in At Home, 9 Farrington St, Glen Innes, Auckland. She married SIANG HUAT OOI 25 Mar 1978 in Auckland, son of HOI OOI and SAW PHAN. He was born 30 Nov 1952 in Malaysia.

Children of LYNETTE HANDRICKS and SIANG OOI are:

- i. LISA MARGARET¹² OOI, b. 20 Oct 1981.
31. ii. FIONA MAY OOI, b. 22 Mar 1984, Auckland.
- iii. ROBYN JANE OOI, b. 31 Dec 1987.

27. GLENN PETER¹¹ HANDRICKS (*NORMA MARGARET LOUISA¹⁰ HARRIS, FREDERICK JOHN⁹, CHARLES STREATER⁸, JOHN STANDEN⁷, JOHN FRANCIS⁶, EDWARD⁵, RICHARD⁴, RICHARD³, WILLIAM², WILLIAM¹*) was born 03 Mar 1966 in Middlemore Hospital, Auckland. He married (1) JUNE ELIZABETH DAVISON 12 Sep 1987 in Auckland, daughter of ROY BRINK and MARJORIE PAPE. She was born 06 Mar 1966 in Australia. He married (2) FAY LUCINDA WILKINSON 13 Jul 2019 in Sandy Creek, Queensland, daughter of ROBERT WILKINSON and LEILA SANDERS. She was born 04 Mar 1965 in Horsham, Victoria.

Children of GLENN HANDRICKS and JUNE DAVISON are:

- i. KIMBERLEY MARIE¹² HANDRICKS, b. 15 Jul 1995, Auckland.
- ii. KELLIE JUNE HANDRICKS, b. 15 Mar 1998, Auckland.

28. PAMELA MARY¹¹ GIBSON (*FLORENCE IRENE¹⁰ TOWNSEND, FLORENCE ELIZABETH⁹ HARRIS, CHARLES STREATER⁸, JOHN STANDEN⁷, JOHN FRANCIS⁶, EDWARD⁵, RICHARD⁴, RICHARD³, WILLIAM², WILLIAM¹*) was born 29 Dec 1954 in Kidderminster Worcs. She married PETER MAY, son of DENNIS MAY and PAT BUTCHER.

Children of PAMELA GIBSON and PETER MAY are:

- i. TIMOTHY¹² MAY, b. 19 Jun 1983.
- ii. RUTH MAY, b. 13 Mar 1985.
- iii. SAMUEL MAY, b. 23 Apr 1987.
- iv. MATTHEW MAY, b. 17 Feb 1989.
- v. BETHANY MAY, b. 17 Dec 1991.
- vi. ANDREW MAY, b. 27 Jul 1993.
- vii. FREYA MAY, b. 20 Oct 1997.

29. BARBARA DENISE¹¹ GIBSON (*FLORENCE IRENE¹⁰ TOWNSEND, FLORENCE ELIZABETH⁹ HARRIS, CHARLES STREATER⁸, JOHN STANDEN⁷, JOHN FRANCIS⁶, EDWARD⁵, RICHARD⁴, RICHARD³, WILLIAM², WILLIAM¹*) was born 22 Mar 1957 in Kidderminster Worcs. She married CHARLES MURRAY.

Children of BARBARA GIBSON and CHARLES MURRAY are:

- i. DEBORAH¹² MURRAY, b. 04 Oct 1988.
- ii. NICHOLA MURRAY, b. 16 Oct 1990.

30. YVONNE MARGARET¹¹ GIBSON (*FLORENCE IRENE¹⁰ TOWNSEND, FLORENCE ELIZABETH⁹ HARRIS, CHARLES STREATER⁸, JOHN STANDEN⁷, JOHN FRANCIS⁶, EDWARD⁵, RICHARD⁴, RICHARD³, WILLIAM², WILLIAM¹*) was born 01 Dec 1958 in Kidderminster Worcs. She married GERARD HENRY GARDNER 19 May 1981 in Preston Registry Office.

Children of YVONNE GIBSON and GERARD GARDNER are:

- i. DONNA JAYNE¹² GARDNER, b. 19 Aug 1981, Preston Royal Infirmary.
- ii. SEAN THOMAS GARDNER, b. 06 Jun 1983.
- iii. ELLEN PAULA GARDNER, b. 10 Nov 1984.
- iv. SARAH LOUISE GARDNER, b. 21 Nov 1985.

Generation No. 12

31. FIONA MAY¹² OOI (*LYNETTE MARGARET*¹¹ *HANDRICKS*, *NORMA MARGARET LOUISA*¹⁰ *HARRIS*, *FREDERICK JOHN*⁹, *CHARLES STREATER*⁸, *JOHN STANDEN*⁷, *JOHN FRANCIS*⁶, *EDWARD*⁵, *RICHARD*⁴, *RICHARD*³, *WILLIAM*², *WILLIAM*¹) was born 22 Mar 1984 in Auckland. She married ANTONIO MASTELLONE 19 Oct 2014 in Massa Lubrense, Italy.

Child of FIONA OOI and ANTONIO MASTELLONE is:

- i. SILVANA¹³ MASTELLONE, b. 05 Jan 2016, Italy.

Descendants of (The Shephardi) Henriques Valentine

Generation No. 1

1. (THE SHEPHARDI) HENRIQUES¹ VALENTINE was born 1620.

Child of (THE SHEPHARDI) HENRIQUES VALENTINE is:

2. i. DANIEL HENRIQUES² VALENTINE, b. Abt. 1645, London Middlesex England; d. 29 Apr 1679, London Middlesex England.

Generation No. 2

2. DANIEL HENRIQUES² VALENTINE (? (THE SHEPHARDI) HENRIQUES¹) was born Abt. 1645 in London Middlesex England, and died 29 Apr 1679 in London Middlesex England. He married JUDITH ?. She was born 1650.

Child of DANIEL VALENTINE and JUDITH ? is:

3. i. MOSHE (MOSES) HENRIQUES³ VALENTINE, b. Abt. 1670, London Middlesex England; d. Feb 1716/17.

Generation No. 3

3. MOSHE (MOSES) HENRIQUES³ VALENTINE (DANIEL HENRIQUES², ? (THE SHEPHARDI) HENRIQUES¹) was born Abt. 1670 in London Middlesex England, and died Feb 1716/17. He married BENVENEDA (DE DAVID) DE SILVA 04 Jul 1694 in Bevis Marks Synagoue London England, daughter of DAVID DE SILVA and BARAH ?. She was born Abt. 1670, and died 1763 in London Middlesex England.

Children of MOSHE VALENTINE and BENVENEDA DE SILVA are:

4. i. DAVID HENRIQUES⁴ VALENTINE, b. Abt. 1699, London, Middlesex, England; d. 1764.
 - ii. JUDITA HENRIQUES VALENTIN, b. Abt. 1693, London, Middlesex, England; m. JEOSUA DA SILVA, 10 Feb 1716/17, London, England.
 - iii. BARAH HENRIQUES HENRIQUES VALENTIN, b. Abt. 1695, London, Middlesex, England; d. 31 Jan 1741/42, Den Haag, Holland; m. (1) ISAQUE ISRAEL MELO, 07 Dec 1718, London, England; b. 1698, Antwerp; m. (2) MENASEH ROVIGO, 04 Jun 1724, London, England.
 - iv. HANA HENRIQUES VALENTIN, b. Abt. 1697, London, Middlesex, England; m. JEUDA ALAGEM, 16 Dec 1722, London, England.
 - v. RIBCA HENRIQUES VALENTIN, b. Abt. 1698, London, Middlesex, England; m. MENASEH ROVIGO, 04 Jun 1724, London.
5. vi. SARAH HENRIQUES VALENTINE, b. 1701, London, Middlesex, England.

Generation No. 4

4. DAVID HENRIQUES⁴ VALENTINE (MOSHE (MOSES) HENRIQUES³, DANIEL HENRIQUES², ? (THE SHEPHARDI) HENRIQUES¹) was born Abt. 1699 in London, Middlesex, England, and died 1764. He married BENVENIDA (DE DAVID) RAMOS 17 May 1725 in London, England, daughter of DAVID RAMOS. She was born Abt. 1700, and died 1769.

Children of DAVID VALENTINE and BENVENIDA RAMOS are:

6. i. MOSES HENRIQUES⁵ VALENTINE, b. 1730, London, Middlesex, England; d. 11 Feb 1787.
7. ii. DANIEL HENRIQUES VALENTINE, b. 12 Jun 1742.
8. iii. JEHOShUA HENRIQUES VALENTINE, b. 22 May 1744.
- iv. JOSHUA DE ISAAC HENRIQUES VALENTINE, m. RACHEL DA SILVA SOLIS, 25 Feb 1767, London, England.
- v. SARA HENRIQUES VALENTINE, m. ABRAHAM HENRIQUES PIMENTEL, 14 Dec 1768, London England.
- vi. ISAAC (DE DAVID) HENRIQUES VALENTINE, b. 1731; m. SIMHA (DE ELIAS) MANDIL, 09 Jun 1756, Bevis Marks Synagogue, City of London.

5. SARAH HENRIQUES⁴ VALENTINE (*MOSHE (MOSES) HENRIQUES³, DANIEL HENRIQUES², ? (THE SHEPHARDI) HENRIQUES¹*) was born 1701 in London, Middlesex, England. She married DAVID TORRES 06 Mar 1726/27 in London, Middlesex, England. He was born Abt. 1700 in London, Middlesex, England.

Child of SARAH VALENTINE and DAVID TORRES is:

9. i. MOSES⁵ TORRES, b. 1735, Portugal; d. 23 Jan 1799, London, Middlesex, England.

Generation No. 5

6. MOSES HENRIQUES⁵ VALENTINE (*DAVID HENRIQUES⁴, MOSHE (MOSES) HENRIQUES³, DANIEL HENRIQUES², ? (THE SHEPHARDI) HENRIQUES¹*) was born 1730 in London, Middlesex, England, and died 11 Feb 1787. He married ESTHER (DE BENJAMIN) MENDES MOMFORTE 22 Jun 1757 in London, England, daughter of BENJAMIN MOMFORTE and SARAH CARVALHO. She was born Bef. 1739.

Children of MOSES VALENTINE and ESTHER MOMFORTE are:

10. i. EMANUEL DE MOSES HENRIQUES⁶ VALENTINE, b. 06 Apr 1769, London; d. 21 Apr 1844, London, England.
11. ii. DANIEL HENRIQUES VALENTINE.
12. iii. BENVENIDA DE ISAAC HENRIQUES VALENTINE, b. Abt. 1756; d. 29 Jan 1815, London.
13. iv. DAVID HENRIQUES VALENTINE, b. 06 Dec 1759, London; d. 16 Apr 1837, New York.
14. v. ELIAS HENRIQUES VALENTINE, b. 1771, Aldgate, Middlesex.
vi. ESTHER HENRIQUES VALENTINE, m. JACOB MASIAH, 24 Aug 1785; b. 1760.
vii. JOSHUA (DE ISAAC) HENRIQUES VALENTINE, b. Abt. 1760; m. RACHEL DA SILVA FONSECA, 25 Feb 1767.

7. DANIEL HENRIQUES⁵ VALENTINE (*DAVID HENRIQUES⁴, MOSHE (MOSES) HENRIQUES³, DANIEL HENRIQUES², ? (THE SHEPHARDI) HENRIQUES¹*) was born 12 Jun 1742. He married DEBORAH (DE ABRAHAM) LURIA 05 Dec 1764 in London, England, daughter of ABRAHAM LURIA and ESTHER MIRANDA.

Children of DANIEL VALENTINE and DEBORAH LURIA are:

15. i. WELCOME (BENVENIEDA) HENRIQUES⁶ VALENTINE.
16. ii. ESTHER HENRIQUES VALENTINE.

8. JEHOShUA HENRIQUES⁵ VALENTINE (*DAVID HENRIQUES⁴, MOSHE (MOSES) HENRIQUES³, DANIEL HENRIQUES², ? (THE SHEPHARDI) HENRIQUES¹*) was born 22 May 1744. He married RIBCA (DE ISAAC) LOPES PEREIRA 05 Apr 1765 in Bevis Marks Synagogue, London, England.

Child of JEHOShUA VALENTINE and RIBCA PEREIRA is:

17. i. DAVID (DE JEHOShUA) HENRIQUES⁶ VALENTINE, b. 12 Mar 1770, London; d. 1832.

9. MOSES⁵ TORRES (*SARAH HENRIQUES⁴ VALENTINE, MOSHE (MOSES) HENRIQUES³, DANIEL HENRIQUES², ? (THE SHEPHARDI) HENRIQUES¹*) was born 1735 in Portugal, and died 23 Jan 1799 in London, Middlesex, England. He married SARAH ALVERES DA COSTA. She was born 1735 in Portugal, and died 28 Feb 1800 in London, Middlesex, England.

Children of MOSES TORRES and SARAH DA COSTA are:

18. i. ABRAHAM⁶ TORRES, b. 21 May 1766, London, Middlesex, England; d. 21 Jan 1818, Whitechapel, Middlesex, England.
ii. ISAAC TORRES, b. 09 Feb 1760, London, Middlesex, England.
iii. ISHAK TORRES, b. 18 Dec 1762, London, Middlesex, England.
iv. SAMUEL TORRES, b. 03 Dec 1764, London, Middlesex, England.
v. BENJAMIN TORRES, b. 17 Dec 1767, London, Middlesex, England.
vi. PHINHAS TORRES, b. 09 Mar 1769, London, Middlesex, England.

Generation No. 6

10. EMANUEL DE MOSES HENRIQUES⁶ VALENTINE (*MOSES HENRIQUES*⁵, *DAVID HENRIQUES*⁴, *MOSHE (MOSES) HENRIQUES*³, *DANIEL HENRIQUES*², ? (*THE SHEPHARDI HENRIQUES*¹)) was born 06 Apr 1769 in London, and died 21 Apr 1844 in London, England. He married LEAH (CLARA) DE SAUL RODRIGUES 09 Sep 1789 in Bevis Marks Synagogue, London, England, daughter of SAUL DE RODRIGUES and SIPPORA ABENDANA. She was born Abt. 1770 in London, England, and died 02 Feb 1844 in Shoreditch, Middlesex, England.

Children of EMANUEL VALENTINE and LEAH RODRIGUES are:

19. i. ISAAC HENRIQUES⁷ VALENTINE, b. 1815, Mile End, Middlesex, England; d. 14 Feb 1908, Whitechapel Middlesex London England.
20. ii. SAUL HENRIQUES VALENTINE, b. 16 Oct 1795, Spitalfields, Middlesex, England; d. 21 Nov 1865, London.
21. iii. MOSES HENRIQUES VALENTINE, b. 23 Aug 1794, London; d. 1870.
22. iv. CLARA HENRIQUES VALENTINE, b. 31 Jul 1801, Spitalfields, London; d. 06 Jul 1883, Mile End.
23. v. DAVID HENRIQUES VALENTINE, b. 30 Jun 1803, Spitalfields, London; d. 1871, London.
24. vi. ABRAHAM HENRIQUES VALENTINE, b. 30 Nov 1809, Spitalfields, Middlesex London, England; d. 02 Oct 1848, Whitechapel, London.
25. vii. BENJAMIN HENRIQUES VALENTINE, b. 24 May 1811, Mile End, Middlesex, England; d. 1898.
26. viii. ESTHER HENRIQUES VALENTINE, b. 1799, Spitalfields, London.
27. ix. EMANUEL HENRIQUES VALENTINE, b. 1809, Spitalfields, London; d. 1888.
28. x. JULIA (YEHUDIT) HENRIQUES VALENTINE, b. Abt. 1816, Middlesex, London.

11. DANIEL HENRIQUES⁶ VALENTINE (*MOSES HENRIQUES*⁵, *DAVID HENRIQUES*⁴, *MOSHE (MOSES) HENRIQUES*³, *DANIEL HENRIQUES*², ? (*THE SHEPHARDI HENRIQUES*¹)) He married LEAH SIMONS 27 Jun 1802 in London, England.

Children of DANIEL VALENTINE and LEAH SIMONS are:

- i. AARON HENRIQUES⁷ VALENTINE.
- ii. CLARA HENRIQUES VALENTINE, m. SAMUEL RODRIGUES, 02 Dec 1821, London, England.
- iii. DAVID HENRIQUES VALENTINE, m. SARAH COHEN, 29 Aug 1827, London, England.
- iv. ESTHER HENRIQUES VALENTINE, m. JOSEPH RODRIGUES MENDES, 06 Jun 1827, London, England.
- v. JACOB HENRIQUES VALENTINE, m. AMELIA DE ?, 15 Aug 1832.

12. BENVENIDA DE ISAAC HENRIQUES⁶ VALENTINE (*MOSES HENRIQUES*⁵, *DAVID HENRIQUES*⁴, *MOSHE (MOSES) HENRIQUES*³, *DANIEL HENRIQUES*², ? (*THE SHEPHARDI HENRIQUES*¹)) was born Abt. 1756, and died 29 Jan 1815 in London. She married SOLOMON DA SILVA SOLIS 13 May 1778 in London, England, son of JACOB SOLIS and JUDITH SOLIS. He was born 28 Aug 1754 in Amsterdam, and died 07 Nov 1847 in London.

Children of BENVENIDA VALENTINE and SOLOMON SOLIS are:

29. i. JACOB DA SILVA⁷ SOLIS, b. 04 Aug 1780, London; d. 29 Dec 1829, Mt. Pleasant, Westchester Co., New York.
- ii. ISAAC DA SILVA SOLIS, b. 22 Oct 1782.
- iii. SIMHA DA SILVA SOLIS, b. 16 Jun 1786.
- iv. DAVID DA SILVA SOLIS, b. 16 Mar 1789.
- v. ABRAHAM DA SILVA SOLIS, b. 15 Aug 1792.
- vi. ELIJAH DA SILVA SOLIS, b. 23 Apr 1794.
- vii. SAMUEL DA SILVA SOLIS, b. 31 Mar 1797.
- viii. JOSHUA DA SILVA SOLIS, b. 08 Jul 1799.
- ix. JUDITH DA SILVA SOLIS.
- x. BENVENIDA DA SILVA SOLIS, b. 01 Feb 1805.
30. xi. DANIEL SOLIS, b. 14 Feb 1784, London, England; d. 1867, Philadelphia, Pennsylvania.

13. DAVID HENRIQUES⁶ VALENTINE (*MOSES HENRIQUES*⁵, *DAVID HENRIQUES*⁴, *MOSHE (MOSES) HENRIQUES*³, *DANIEL HENRIQUES*², ? (*THE SHEPHARDI HENRIQUES*¹)) was born 06 Dec 1759 in London, and died 16 Apr 1837 in New York. He married (1) ELIZABETH JEWEL. She was born Oct 1759, and died 11 Jul 1835. He married (2) SARA SILVA PORTO 17 Nov 1784 in London, England.

Children of DAVID VALENTINE and ELIZABETH JEWEL are:

31. i. SAMUEL⁷ VALENTINE, b. 1801, New York, New York; d. 23 Oct 1855, Brooklyn, NY.
32. ii. REBECCA HENRIQUES VALENTINE, b. 1786, London; d. 27 Feb 1821.
33. iii. ISAAC DAVID HENRIQUES VALENTINE, b. 1787, Holland; d. 26 Dec 1842, Montreal.
- iv. CATHERINE (KITTY) HENRIQUES VALENTINE, b. 1788.
- v. ELIAS HENRIQUES VALENTINE, b. 1795.
- vi. SEMIRA HENRIQUES VALENTINE, b. 1807; d. 08 Sep 1849, New York; m. EDWARD BARNETT, 11 Dec 1833, New York.

14. ELIAS HENRIQUES⁶ VALENTINE (*MOSES HENRIQUES⁵, DAVID HENRIQUES⁴, MOSHE (MOSES) HENRIQUES³, DANIEL HENRIQUES², ? (THE SHEPHARDI) HENRIQUES¹*) was born 1771 in Aldgate, Middlesex. He married RIBCA DE AARON ALVARES DA COSTA 03 Jul 1792 in London, England. She was born Abt. 1784, and died 1841.

Children of ELIAS VALENTINE and RIBCA DA COSTA are:

- i. HANNAH HENRIQUES⁷ VALENTINE, b. 1800, Shoreditch, London; m. SOLOMON ISAACS.
- ii. WELCOME VALENTINE, b. 01 Oct 1802, Aldgate, Middlesex; d. 1870.
- iii. DAVID VALENTINE, b. 1805, Shoreditch, London; d. 28 Oct 1871; m. ISABELLA (DE MORDECAI) BENJAMIN, 15 Jul 1840, Bevis Marks; b. 1799, Strand, London.
34. iv. JACOB (DE ELIAS) HENRIQUES VALENTINE, b. 1810, Shoreditch, London; d. 05 Dec 1864, Shoreditch, London.
35. v. AARON (DE ELIAS) HENRIQUES VALENTINE, b. Abt. 1796, Middlesex, London.
- vi. ANN VALENTINE, b. 1809.
36. vii. SAUL HENRIQUES VALENTINE, b. Abt. 1807; d. 11 Apr 1847, Shoreditch, London.
- viii. WILLIAM VALENTINE, b. 1811.

15. WELCOME (BENVENIEDA) HENRIQUES⁶ VALENTINE (*DANIEL HENRIQUES⁵, DAVID HENRIQUES⁴, MOSHE (MOSES) HENRIQUES³, DANIEL HENRIQUES², ? (THE SHEPHARDI) HENRIQUES¹*)

Child of WELCOME (BENVENIEDA) HENRIQUES VALENTINE is:

- i. SIMHA⁷ ?.

16. ESTHER HENRIQUES⁶ VALENTINE (*DANIEL HENRIQUES⁵, DAVID HENRIQUES⁴, MOSHE (MOSES) HENRIQUES³, DANIEL HENRIQUES², ? (THE SHEPHARDI) HENRIQUES¹*) She married EMANUEL NUNES CASTELLO.

Children of ESTHER VALENTINE and EMANUEL CASTELLO are:

37. i. JACOB NUNES⁷ CASTELLO.
- ii. DANIEL NUNES CASTELLO, d. 24 Nov 1866, Rio de Janeiro; m. RACHEL LEVY, 30 Jul 1832, London; d. 11 Oct 1878, Rio de Janeiro.

17. DAVID (DE JEHOShUA) HENRIQUES⁶ VALENTINE (*JEHOShUA HENRIQUES⁵, DAVID HENRIQUES⁴, MOSHE (MOSES) HENRIQUES³, DANIEL HENRIQUES², ? (THE SHEPHARDI) HENRIQUES¹*) was born 12 Mar 1770 in London, and died 1832. He married RACHEL ? 27 Jun 1802 in Bevis Marks Synagogue, London. She was born Abt. 1777 in Whitechapel, and died 1863.

Child of DAVID VALENTINE and RACHEL ? is:

38. i. JOSEPH MOSES⁷ VALENTINE, b. 1805, Spitalfields, Middlesex; d. Bef. 1864.

18. ABRAHAM⁶ TORRES (*MOSES⁵, SARAH HENRIQUES⁴ VALENTINE, MOSHE (MOSES) HENRIQUES³, DANIEL HENRIQUES², ? (THE SHEPHARDI) HENRIQUES¹*) was born 21 May 1766 in London, Middlesex, England, and died 21 Jan 1818 in Whitechapel, Middlesex, England. He married ESTHER DIAS. She was born 01 Dec 1787 in Bethnal Green, London, England, and died 16 Oct 1865 in London, Middlesex, England.

Children of ABRAHAM TORRES and ESTHER DIAS are:

39. i. MOSES DE ABRAHAM⁷ TORRES, b. 14 Jan 1808, London, Middlesex, England; d. 29 Nov 1860, Philadelphia, Pennsylvania, USA.
- ii. ABIGAIL TORRES, b. Abt. 1811, Whitechapel, Middlesex, England; d. Jan 1878, Bethnal Green, London; m. RAPHAEL ENOCH COHEN, 07 Mar 1832, London; b. 12 May 1806, Whitechapel, Middlesex, England; d. 02 Jun 1873, London.
- iii. SARAH TORRES, b. 08 Mar 1806, London, Middlesex, England.
- iv. MIRIAM TORRES, b. 1812, London, Middlesex, England.
- v. RACHEL TORRES, b. 1814, London, Middlesex, England.
- vi. HANNAH TORRES, b. 1817, London, Middlesex, England.

Generation No. 7

19. ISAAC HENRIQUES⁷ VALENTINE (*EMANUEL DE MOSES HENRIQUES⁶, MOSES HENRIQUES⁵, DAVID HENRIQUES⁴, MOSHE (MOSES) HENRIQUES³, DANIEL HENRIQUES², ? (THE SHEPHARDI) HENRIQUES¹*) was born 1815 in Mile End, Middlesex, England, and died 14 Feb 1908 in Whitechapel Middlesex London England. He married JULIA (YETTA) SOLOMONS 05 Sep 1841 in Bevis Marks London City, daughter of ABRAHAM SOLOMONS and FANNY ISRAEL. She was born 1817 in Aldgate, Middlesex, England, and died 30 Jan 1901 in Whitechapel Middlesex London England.

Children of ISAAC VALENTINE and JULIA SOLOMONS are:

40. i. COLEMAN (COLONIMUS) HENRIQUES⁸ VALENTINE, b. 04 Dec 1854, Hartford St, Houndsditch, East London; d. 1946, Stepney, London.
41. ii. CATHERINE (KATE) HENRIQUES VALENTINE, b. 1848, Aldgate, Middlesex, England.
42. iii. BENJAMIN HENRIQUES VALENTINE, b. 27 Jun 1860, Aldgate Middlesex London England; d. 10 Nov 1936.
43. iv. ALFRED VALENTINE.
44. v. JOSEPH EMANUEL VALENTINE, b. 1838, Aldgate, London, England; d. 1877, London.
- vi. JACK VALENTINE.
45. vii. SOPHIA (ZIPORAH) VALENTINE, b. 14 Sep 1858, Aldgate, Middlesex, England.
46. viii. JANE (JAE) HENRIQUES VALENTINE, b. 24 Jan 1855, London, England.
47. ix. LEAH HENRIQUES VALENTINE, b. 31 Mar 1846, Aldgate London Middlesex England; d. 1901.
48. x. CAROLINE (KANANDELA) HENRIQUES VALENTINE, b. 16 Dec 1852, Aldgate Middlesex London England.
49. xi. ABRAHAM HENRIQUES VALENTINE, b. 29 Jan 1842, Aldgate, Middlesex, England; d. 22 Feb 1929, Stepney, London.
- xii. DAVID HENRIQUES VALENTINE, b. 20 Mar 1850, Spitalfields Middlesex London England; d. 25 Jan 1852, East London Middlesex London England.
50. xiii. REBECCA HENRIQUES VALENTINE, b. 16 Jan 1844, Aldgate Middlesex London England; d. 24 May 1915.
- xiv. ASHER VALENTINE, b. Abt. 1852, Aldgate Middlesex London England; d. 1852.

20. SAUL HENRIQUES⁷ VALENTINE (*EMANUEL DE MOSES HENRIQUES⁶, MOSES HENRIQUES⁵, DAVID HENRIQUES⁴, MOSHE (MOSES) HENRIQUES³, DANIEL HENRIQUES², ? (THE SHEPHARDI) HENRIQUES¹*) was born 16 Oct 1795 in Spitalfields, Middlesex, England, and died 21 Nov 1865 in London. He married (1) SARAH RIVERS 1844 in Duke's Place, London City, England. He married (2) SARAH RUSSELL 14 Jun 1854 in Bevis Marks, London, England, daughter of SAMUEL RUSSELL and CATHERINE MYERS. She was born 1830 in Sheerness, Kent, England, and died 1864 in East London, Middlesex, England.

Child of SAUL VALENTINE and SARAH RIVERS is:

- i. SUSAN⁸ VALENTINE, b. 1842, Spitalfields, London; d. 1893, Holborn.

Children of SAUL VALENTINE and SARAH RUSSELL are:

51. ii. SARAH CONSTANCE ENRIQUES⁸ VALENTINE, b. 17 Nov 1864, London City, London, England; d. 1937, London, Middlesex, England.
52. iii. SAUL HENRIQUES VALENTINE, b. 16 Sep 1855, St. Botolph; d. 15 Sep 1937, Croydon, Surrey.
- iv. SAMUEL RUSSELL HENRIQUES VALENTINE, b. 15 Dec 1858, East London, Middlesex, England; d. 1859, East London, Middlesex, England.
53. v. KATE (KETURA) VALENTINE, b. 23 Jul 1860, East London, Middlesex, England; d. 1906, West Ham, Essex, England.

21. MOSES HENRIQUES⁷ VALENTINE (*EMANUEL DE MOSES HENRIQUES⁶, MOSES HENRIQUES⁵, DAVID HENRIQUES⁴, MOSHE (MOSES) HENRIQUES³, DANIEL HENRIQUES², ? (THE SHEPHARDI) HENRIQUES¹*) was born 23 Aug 1794 in London, and died 1870. He married JUDITH RODRIGUES-RIBEIRO 08 Sep 1817 in Bevis Marks Synogigue, London, London, England, daughter of SOLOMON RODRIGUES-RIBEIRO and BENVENIDA MENDOZA. She was born Abt. 1794 in London.

Children of MOSES VALENTINE and JUDITH RODRIGUES-RIBEIRO are:

- i. LEAH⁸ VALENTINE, b. 1817, Whitechapel, London.
- ii. SARAH HENRIQUES VALENTINE, b. 1818, Whitechapel, London; m. (1) WILLIAM ERROL; b. 1818, Middlesex, London; m. (2) EMANUEL HENRIQUES VALENTINE; b. 1809, Spitalfields, London; d. 1888.
54. iii. HANNAH VALENTINE, b. Abt. 1822, Whitechapel, London.
- iv. ISAAC VALENTINE, b. 08 Feb 1824, Whitechapel, London.
- v. EMANUEL VALENTINE, b. Abt. 1826, Shoreditch, London; m. ANN BRANSON, 11 May 1851, St. Leonard, Shoreditch.
- vi. ESTHER VALENTINE, b. Abt. 1827.
- vii. JULIA VALENTINE, b. 1829, St Lukes Old Street.

22. CLARA HENRIQUES⁷ VALENTINE (*EMANUEL DE MOSES HENRIQUES⁶, MOSES HENRIQUES⁵, DAVID HENRIQUES⁴, MOSHE (MOSES) HENRIQUES³, DANIEL HENRIQUES², ? (THE SHEPHARDI) HENRIQUES¹*) was born 31 Jul 1801 in Spitalfields, London, and died 06 Jul 1883 in Mile End. She married SAMUEL DE SAUL RODRIGUES 1822 in Bevis Marks, son of SAUL RODRIGUES.

Children of CLARA VALENTINE and SAMUEL RODRIGUES are:

- i. SAUL⁸ RODRIGUES, b. 1845, Whitechapel.
- ii. EMANUEL RODRIGUES, b. Abt. 1836, Whitechapel.
- iii. REBECCA RODRIGUES, b. Abt. 1837, Whitechapel.

23. DAVID HENRIQUES⁷ VALENTINE (*EMANUEL DE MOSES HENRIQUES⁶, MOSES HENRIQUES⁵, DAVID HENRIQUES⁴, MOSHE (MOSES) HENRIQUES³, DANIEL HENRIQUES², ? (THE SHEPHARDI) HENRIQUES¹*) was born 30 Jun 1803 in Spitalfields, London, and died 1871 in London. He married (1) SARAH (DE HANOJ) COHEN 29 Aug 1827, daughter of ENOCH COHEN and JUDITH ABENDANA. He married (2) AGAR (DE HANOJ) COHEN 31 Jul 1833 in London, daughter of ENOCH COHEN and JUDITH ABENDANA. She was born 17 Dec 1812 in Whitechapel, London, and died 17 Feb 1858 in London. He married (3) ABIGAIL GARCIA 30 Aug 1863 in Bevis Marks.

Children of DAVID VALENTINE and SARAH COHEN are:

- i. LEAH⁸ VALENTINE, b. 1829, City St Botolph.
- ii. EMANUEL VALENTINE, b. 1829.

Child of DAVID VALENTINE and AGAR COHEN is:

- iii. LEAH⁸ VALENTINE, b. 1828, Bishopsgate, London, England; d. 1901, Poplar, London; m. MOSES LIPMAN, 1862, London; b. Abt. 1816, London; d. 1890, Poplar, London.

24. ABRAHAM HENRIQUES⁷ VALENTINE (*EMANUEL DE MOSES HENRIQUES⁶, MOSES HENRIQUES⁵, DAVID HENRIQUES⁴, MOSHE (MOSES) HENRIQUES³, DANIEL HENRIQUES², ? (THE SHEPHARDI) HENRIQUES¹*) was born 30 Nov 1809 in Spitalfields, Middlesex London, England, and died 02 Oct 1848 in Whitechapel, London. He married JUDITH DE MORDECHAI MENDOZA 26 Aug 1831 in London, England, daughter of MORDECAI MENDOZA and ZIPPORAH LEVY. She was born 09 Feb 1810 in London, England, and died 25 Feb 1902 in Mile End.

Children of ABRAHAM VALENTINE and JUDITH MENDOZA are:

- i. ABRAHAM HENRIQUES⁸ VALENTINE, b. London, Middlesex, England.
- ii. HANNAH HENRIQUES VALENTINE, b. London, Middlesex, England; m. SOLOMON ISAACS, 12 Dec 1866, London, England.
- iii. DAVID HENRIQUES VALENTINE, b. London, Middlesex, England; m. ABIGAIL GARCIA, 30 Aug 1863, London, England.
55. iv. EMANUEL HENRIQUES VALENTINE, b. 23 Apr 1834, London, Middlesex, England; d. 1877, Mile End Old Town.
56. v. AMELIA HENRIQUES VALENTINE, b. 1842, London, Middlesex, England; d. Dec 1885, Liverpool, Lancashire.
- vi. JUDAH HENRIQUES VALENTINE, b. 08 Dec 1848, London, Middlesex, England; m. JANE COHEN, 28 Jun 1871, London, England.
- vii. MOSES HENRIQUES VALENTINE, b. 10 Feb 1842, London, Middlesex, England; m. SARAH JOSEPH, 01 Mar 1865, Spitalfields, London, England.
57. viii. SAUL HENRIQUES VALENTINE, b. 07 Feb 1844, London, Middlesex, England.
- ix. MORDECAI HENRIQUES VALENTINE, b. 30 Aug 1835, London, Middlesex, England; m. HANNAH NUNES MARTIN, 28 Mar 1860, London England.
- x. LEAH HENRIQUES VALENTINE, b. 01 Nov 1831, London, Middlesex, England.
- xi. EMMANUEL VALENTINE, b. 1832, London, Middlesex, England.
- xii. SOPHIA HENRIQUES VALENTINE, b. 1838, London, Middlesex, England.
- xiii. ELIZABETH (BATHSHEBA) HENRIQUES VALENTINE, b. 1840, London, Middlesex, England; m. ISAAC ALVAREZ, 15 Aug 1866, London England; b. 02 Sep 1841, London England.

25. BENJAMIN HENRIQUES⁷ VALENTINE (*EMANUEL DE MOSES HENRIQUES⁶, MOSES HENRIQUES⁵, DAVID HENRIQUES⁴, MOSHE (MOSES) HENRIQUES³, DANIEL HENRIQUES², ? (THE SHEPHARDI) HENRIQUES¹*) was born 24 May 1811 in Mile End, Middlesex, England, and died 1898. He married ESTHER HARTELL 29 Dec 1847 in Bevis Marks, daughter of JOSEPH HARTELL. She was born 1828 in Whitechapel, London.

Children of BENJAMIN VALENTINE and ESTHER HARTELL are:

58. i. EMANUEL⁸ VALENTINE, b. 20 Sep 1848, Middlesex, London.
- ii. JOSEPH VALENTINE, b. 18 Feb 1854.
- iii. SIMHA VALENTINE, b. 25 Jan 1859.
- iv. JACOB VALENTINE, b. 16 Feb 1861, Bishopsgate, London; m. PHOEBE KADISH, 1887.
- v. ISAAC VALENTINE, b. 17 Jan 1864.
- vi. HANNAH VALENTINE, b. 1866.
- vii. ALICE VALENTINE, b. 1868.
- viii. SARAH VALENTINE, b. 18 Jul 1873, Mile End, London.

26. ESTHER HENRIQUES⁷ VALENTINE (*EMANUEL DE MOSES HENRIQUES⁶, MOSES HENRIQUES⁵, DAVID HENRIQUES⁴, MOSHE (MOSES) HENRIQUES³, DANIEL HENRIQUES², ? (THE SHEPHARDI) HENRIQUES¹*) was born 1799 in Spitalfields, London. She married JOSEPH DE ABRAHAM RODRIGUES MENDES 1827, son of ABRAHAM RODRIGUES MENDES. He was born 06 Nov 1799.

Children of ESTHER VALENTINE and JOSEPH MENDES are:

- i. ABRAHAM⁸ MENDES, b. 1826, Manchester.
- ii. SARAH MENDES, b. 1827, Manchester.
- iii. REBECCA MENDES, b. 1837.
- iv. JOSEPH MENDES, b. 1838, Sheffield, Yorkshire.

27. EMANUEL HENRIQUES⁷ VALENTINE (*EMANUEL DE MOSES HENRIQUES⁶, MOSES HENRIQUES⁵, DAVID HENRIQUES⁴, MOSHE (MOSES) HENRIQUES³, DANIEL HENRIQUES², ? (THE SHEPHARDI) HENRIQUES¹*) was born 1809 in Spitalfields, London, and died 1888. He married (1) SARAH HENRIQUES VALENTINE, daughter of MOSES VALENTINE and JUDITH RODRIGUES-RIBEIRO. She was born 1818 in Whitechapel, London. He married (2) REBECCA (DE JACOB) MYERS 1828 in Bevis Marks. She was born 1811 in Birmingham.

Child of EMANUEL VALENTINE and REBECCA MYERS is:

- i. EMANUEL⁸ VALENTINE, b. 1828.

28. JULIA (YEHUDIT) HENRIQUES⁷ VALENTINE (*EMANUEL DE MOSES HENRIQUES⁶, MOSES HENRIQUES⁵, DAVID HENRIQUES⁴, MOSHE (MOSES) HENRIQUES³, DANIEL HENRIQUES², ? (THE SHEPHARDI) HENRIQUES¹*) was born Abt. 1816 in Middlesex, London. She married ALEXANDER LYONS 21 Sep 1834. He was born Abt. 1816 in Middlesex, London.

Children of JULIA VALENTINE and ALEXANDER LYONS are:

- i. ELIZABETH⁸ LYONS, b. 1834, Middlesex, London.
- ii. LEAH LYONS, b. 1836, Middlesex, London.
- iii. CATHERINE LYONS, b. 1838, Middlesex, London.
- iv. EMANUEL LYONS, b. 1840, Middlesex, London.

29. JACOB DA SILVA⁷ SOLIS (*BENVENIDA DE ISAAC HENRIQUES⁶ VALENTINE, MOSES HENRIQUES⁵, DAVID HENRIQUES⁴, MOSHE (MOSES) HENRIQUES³, DANIEL HENRIQUES², ? (THE SHEPHARDI) HENRIQUES¹*) was born 04 Aug 1780 in London, and died 29 Dec 1829 in Mt. Pleasant, Westchester Co., New York. He married CHARITY HAYES 1811, daughter of DAVID HAYES and ESTHER ETING. She was born 14 Mar 1782 in Bedford, New York, and died 20 Jul 1839 in 20 Jul 1839.

Children of JACOB SOLIS and CHARITY HAYES are:

59. i. SOLOMON DA SILVA⁸ SOLIS, b. 23 Mar 1819, Wilmington, Delaware; d. 22 Jun 1854, New York.
60. ii. DAVID HAYS SOLIS, b. 28 May 1822, Mt. Pleasant, Westchester Co., New York; d. 30 Nov 1882, Philadelphia, Pennsylvania.
61. iii. BENVENIDA SOLIS, b. 17 Jan 1813, Mt. Pleasant, Westchester Co., New York; d. 15 Jan 1892, New York.
- iv. ESTHER ETING SOLIS, b. 16 Mar 1815, Wilmington, Delaware; d. 24 Aug 1904, Philadelphia, Pennsylvania.
62. v. JUDITH SIMHA SOLIS, b. 17 May 1817, Wilmington, Delaware; d. 13 Feb 1914, Philadelphia, Pennsylvania.
63. vi. SARAH MIRIAM SOLIS, b. 15 Oct 1824, Mt. Pleasant, Westchester Co., New York; d. 02 May 1894, New York.
64. vii. PHOEBE ELIZABETH SOLIS, b. 30 Mar 1827, Mt Pleasant; d. 30 Nov 1893, Chews Landing, New Jersey.

30. DANIEL⁷ SOLIS (*BENVENIDA DE ISAAC HENRIQUES⁶ VALENTINE, MOSES HENRIQUES⁵, DAVID HENRIQUES⁴, MOSHE (MOSES) HENRIQUES³, DANIEL HENRIQUES², ? (THE SHEPHARDI) HENRIQUES¹*) was born 14 Feb 1784 in London, England, and died 1867 in Philadelphia, Pennsylvania. He married SARAH NORRIS.

Children of DANIEL SOLIS and SARAH NORRIS are:

65.
 - i. ALBIONA⁸ SOLIS.
 - ii. BENVENIDA VALENTINA SOLIS, b. 25 Aug 1815, Wilmington, Delaware, USA; d. 26 Jun 1893; m. MOSES NATHANS.
 - iii. HANNA (ANN) SOLIS, b. 05 Feb 1817, Philadelphia, Pennsylvania, USA; d. 1878; m. (1) ISAAC A. LEVY; m. (2) DR. JOHN A. MARTENBY.
 - iv. BURROWSINA CORDELIA SOLIS, b. Apr 1825; d. 15 Feb 1826.
 - v. BURROWSINA SOLIS, b. 13 Aug 1827; d. 25 May 1864; m. BENJAMIN DAVIS, 16 Oct 1845; b. 1807, Richmond, Virginia, USA; d. 30 Dec 1879.

31. SAMUEL⁷ VALENTINE (*DAVID HENRIQUES⁶, MOSES HENRIQUES⁵, DAVID HENRIQUES⁴, MOSHE (MOSES) HENRIQUES³, DANIEL HENRIQUES², ? (THE SHEPHARDI) HENRIQUES¹*) was born 1801 in New York, New York, and died 23 Oct 1855 in Brooklyn, NY. He married MARY REBECCA MCEEVERS, daughter of JOHN MCEEVERS and ANN WEIR. She was born 10 Jun 1807 in New York, New York, and died 21 Jun 1876 in Brooklyn, New York City, New York, USA.

Children of SAMUEL VALENTINE and MARY MCEEVERS are:

66.
 - i. SAMUEL⁸ VALENTINE, b. Jan 1835, Brooklyn Ward 4, Kings Cty, New York; d. 10 Sep 1916, Brooklyn, Kings, New York, United States.
 - ii. ANN ELIZA VALENTINE, b. 29 Oct 1826, Brooklyn Ward 4, Kings Cty, New York.
 - iii. DAVID VALENTINE, b. 01 Feb 1829, New York City, NY.
 - iv. ROBERT GORDON VALENTINE, b. 1831, Brooklyn Ward 4, Kings Cty, New York.
 - v. ISAAC VALENTINE, b. 1833, Brooklyn Ward 4, Kings Cty, New York.
 - vi. MARY AUGUSTA VALENTINE, b. 14 Feb 1840, Brooklyn Ward 4, Kings Cty, New York.
 - vii. WILLIAM VALENTINE, b. 26 Apr 1841, Brooklyn Ward 4, Kings Cty, New York.
 - viii. EMMA CATHERINE VALENTINE, b. 1848, Brooklyn Ward 4, Kings Cty, New York.

32. REBECCA HENRIQUES⁷ VALENTINE (*DAVID HENRIQUES⁶, MOSES HENRIQUES⁵, DAVID HENRIQUES⁴, MOSHE (MOSES) HENRIQUES³, DANIEL HENRIQUES², ? (THE SHEPHARDI) HENRIQUES¹*) was born 1786 in London, and died 27 Feb 1821. She married JACOB GERSHON BERLIN 17 May 1809 in New York.

Children of REBECCA VALENTINE and JACOB BERLIN are:

67.
 - i. HANNAH⁸ BERLIN, b. 1809, New York; d. 11 Sep 1897, New York; m. ? KRAUTH.
 - ii. LEAH BERLIN, b. 1816, New York; d. 15 Jan 1854, New York.

33. ISAAC DAVID HENRIQUES⁷ VALENTINE (*DAVID HENRIQUES⁶, MOSES HENRIQUES⁵, DAVID HENRIQUES⁴, MOSHE (MOSES) HENRIQUES³, DANIEL HENRIQUES², ? (THE SHEPHARDI) HENRIQUES¹*) was born 1787 in Holland, and died 26 Dec 1842 in Montreal. He married PHOEBE HAYS.

Child of ISAAC VALENTINE and PHOEBE HAYS is:

- i. ISAAC HENRIQUES⁸ VALENTINE.

34. JACOB (DE ELIAS) HENRIQUES⁷ VALENTINE (*ELIAS HENRIQUES⁶, MOSES HENRIQUES⁵, DAVID HENRIQUES⁴, MOSHE (MOSES) HENRIQUES³, DANIEL HENRIQUES², ? (THE SHEPHARDI) HENRIQUES¹*) was born 1810 in Shoreditch, London, and died 05 Dec 1864 in Shoreditch, London. He married AMELIA (MIRIAM) DE MEIR DE URI 15 Aug 1832. She was born in Shoreditch, London.

Children of JACOB VALENTINE and AMELIA DE URI are:

68.
 - i. SARAH HENRIQUES⁸ VALENTINE, b. 28 Feb 1835, Shoreditch, London.
 - ii. HANNAH HENRIQUES VALENTINE, b. 07 Jan 1837, Shoreditch, London; d. 06 Jul 1900.
 - iii. WELCOME VALENTINE, b. 29 Nov 1838, Shoreditch, London; d. 07 Nov 1880, Mile End.
 - iv. AMELIA HENRIQUES VALENTINE, b. 1843, Shoreditch, London; m. ADOLF (ABRAHAM) NEIMAN, 16 Nov 1859.
 - v. REBECCA VALENTINE, b. 18 Jul 1833, Shoreditch, London; d. 18 Oct 1894, Shoreditch, London.

35. AARON (DE ELIAS) HENRIQUES⁷ VALENTINE (*ELIAS HENRIQUES⁶, MOSES HENRIQUES⁵, DAVID HENRIQUES⁴, MOSHE (MOSES) HENRIQUES³, DANIEL HENRIQUES², ? (THE SHEPHARDI) HENRIQUES¹*) was born Abt. 1796 in Middlesex, London. He married REBECCA PALACHE 25 Mar 1818, daughter of ALEXANDER PALACHE and LUNA DE SILVERA. She was born 111.

Children of AARON VALENTINE and REBECCA PALACHE are:

- i. ISAAC HENRIQUES⁸ VALENTINE, m. JULIA SOLOMONS, 05 Sep 1841.
- ii. REBECCA HENRIQUES VALENTINE, b. 1819; d. 18 Oct 1894, 28 Poet's Rd., Canonbury.

36. SAUL HENRIQUES⁷ VALENTINE (*ELIAS HENRIQUES⁶, MOSES HENRIQUES⁵, DAVID HENRIQUES⁴, MOSHE (MOSES) HENRIQUES³, DANIEL HENRIQUES², ? (THE SHEPHARDI) HENRIQUES¹*) was born Abt. 1807, and died 11 Apr 1847 in Shoreditch, London. He married MIRIAM ?. She was born Abt. 1816, and died 1888 in Lambeth.

Children of SAUL VALENTINE and MIRIAM ? are:

- i. REBECCA HENRIQUES⁸ VALENTINE, b. 1834.
- ii. LYDIA HENRIQUES VALENTINE, b. 1837.
69. iii. HANNAH HENRIQUES VALENTINE, b. 13 Feb 1839, Shoreditch, London; d. 1909, Lambeth.
- iv. ELIAS HENRIQUES VALENTINE, b. 1840.
- v. WELCOME HENRIQUES VALENTINE, b. 01 Apr 1842, Strand, London.
- vi. ISAAC HENRIQUES VALENTINE, b. 05 Jan 1846, Shoreditch, London; m. LUCY PLUMMER, 1874, St George, Hanover Square; b. 1851.

37. JACOB NUNES⁷ CASTELLO (*ESTHER HENRIQUES⁶ VALENTINE, DANIEL HENRIQUES⁵, DAVID HENRIQUES⁴, MOSHE (MOSES) HENRIQUES³, DANIEL HENRIQUES², ? (THE SHEPHARDI) HENRIQUES¹*) He married SARAH LEVY.

Children of JACOB CASTELLO and SARAH LEVY are:

- i. MANUAL NUNES⁸ CASTELLO.
- ii. DANIEL NUNES CASTELLO.

38. JOSEPH MOSES⁷ VALENTINE (*DAVID (DE JEHOASHUA) HENRIQUES⁶, JEHOASHUA HENRIQUES⁵, DAVID HENRIQUES⁴, MOSHE (MOSES) HENRIQUES³, DANIEL HENRIQUES², ? (THE SHEPHARDI) HENRIQUES¹*) was born 1805 in Spitalfields, Middlesex, and died Bef. 1864. He married MARIA NEEDHAM 18 Nov 1833 in St John the Baptist, Shoreditch. She was born 1816 in Cripplegate, Shoreditch, Middlesex, and died 1879.

Child of JOSEPH VALENTINE and MARIA NEEDHAM is:

70. i. JOSEPH⁸ VALENTINE, b. 08 Feb 1842, Hoxton Old Town, Middlesex; d. 1913.

39. MOSES DE ABRAHAM⁷ TORRES (*ABRAHAM⁶, MOSES⁵, SARAH HENRIQUES⁴ VALENTINE, MOSHE (MOSES) HENRIQUES³, DANIEL HENRIQUES², ? (THE SHEPHARDI) HENRIQUES¹*) was born 14 Jan 1808 in London, Middlesex, England, and died 29 Nov 1860 in Philadelphia, Pennsylvania, USA. He married JUDITH NOAH DA COSTA 08 Aug 1832 in Bevis Marks London City. She was born 05 Jul 1806 in London, Middlesex, England.

Children of MOSES TORRES and JUDITH DA COSTA are:

- i. RACHEL⁸ TORRES, b. 18 May 1833, London, Middlesex, England.
- ii. SARAH TORRES, b. 1835, London, Middlesex, England.
- iii. ABRAHAM TORRES, b. 01 Oct 1837, London, Middlesex, England.
- iv. JACOB TORRES, b. 17 Feb 1839, London, Middlesex, England.
- v. ESTHER TORRES, b. 25 May 1840, London, Middlesex, England.
- vi. BENJAMIN TORRES, b. 28 Mar 1843, London, Middlesex, England.
- vii. HANNAH TORRES, b. 06 Jan 1845, London, Middlesex, England.
- viii. ISAAC TORRES, b. Sep 1849, New York.

Generation No. 8

40. COLEMAN (COLONIMUS) HENRIQUES⁸ VALENTINE (*ISAAC HENRIQUES⁷, EMANUEL DE MOSES HENRIQUES⁶, MOSES HENRIQUES⁵, DAVID HENRIQUES⁴, MOSHE (MOSES) HENRIQUES³, DANIEL HENRIQUES², ? (THE SHEPHARDI) HENRIQUES¹*) was born 04 Dec 1854 in Hartford St, Hounsditch, East London, and died 1946 in Stepney, London. He married (1) LOUISA ELIZABETH HERRETT 04 Apr 1884 in Mile End Old Town, London, England, daughter of GEORGE HERRETT and MARGARET JONES. She was born 1866 in Liverpool, Lancashire, England, and died 04 Dec 1905 in Southwark, London. He married (2) LETITIA (FRACES) SANDERS 1911 in Est Ham London.

Children of COLEMAN VALENTINE and LOUISA HERRETT are:

71. i. MARGARET MIRIAM (MAY)⁹ VALENTINE, b. 07 Jan 1903, Mile End Road, London, England; d. 02 Sep 1980, Wellington.
72. ii. ARTHUR ISAAC VALENTINE, b. 10 Apr 1885, London City Middlesex London England; d. 1948, Hackney, London.
73. iii. JULIE LOUISA VALENTINE, b. 22 Aug 1888, Maidment St, Bethnal Green, London; d. 01 Jan 1971.
74. iv. JACOB HENRY (JACK) VALENTINE, b. 29 Jan 1895, Mile End, London, England; d. 20 Sep 1984, Hendon, Middx.
75. v. JANE DAVIS VALENTINE, b. 1898, Mile End London England; d. 1987, Chelmsford, Essex.
76. vi. ALFRED (ABRAHAM JOHN) VALENTINE, b. Abt. 1895, Farmbridge Rd, Bethnal Green, London, England.
77. vii. AGNES VALENTINE.
77. viii. EMANUEL JOSEPH VALENTINE, b. 1900, Mile End Rd; d. 1967.
- ix. DAVID GEORGE VALENTINE, b. 1893, Mile End Rd; d. 30 Oct 1918, West Ham.
- x. KATHERINE MARGARET VALENTINE, b. 06 Jan 1887, Bethnal Green, London; d. 1888.

41. CATHERINE (KATE) HENRIQUES⁸ VALENTINE (*ISAAC HENRIQUES⁷, EMANUEL DE MOSES HENRIQUES⁶, MOSES HENRIQUES⁵, DAVID HENRIQUES⁴, MOSHE (MOSES) HENRIQUES³, DANIEL HENRIQUES², ? (THE SHEPHARDI) HENRIQUES¹*) was born 1848 in Aldgate, Middlesex, England. She married LEWIS EMANUEL 29 Jan 1873 in London City Middlesex London England, son of BARNETT EMANUEL and AMELIA ?. He was born Abt. 1837 in Aldgate Middlesex London England, and died 1914 in London.

Children of CATHERINE VALENTINE and LEWIS EMANUEL are:

- i. JULIA⁹ EMANUEL, b. 1875, Aldgate, London, England.
- ii. EMANUEL EMANUEL, b. 1876, Aldgate, London, England.
78. iii. FANNY EMANUEL, b. 1878, Westminster, London, England.
- iv. REBECCA EMANUEL, b. 1879, Aldgate, London, England.
- v. SARAH EMANUEL, b. 1880, Aldgate, London, England.
- vi. MOSS EMANUEL, b. 1873, Westminster, London, England.
- vii. HYAM EMANUEL, b. 1884, Aldgate, London, England.
- viii. CAROLINE EMANUEL, b. 1888, Westminster, London, England.
- ix. GERTRUDE (GERTIE) EMANUEL, b. 1890, Aldgate, London, England.
- x. ESTHER EMANUEL, b. 1895.

42. BENJAMIN HENRIQUES⁸ VALENTINE (*ISAAC HENRIQUES⁷, EMANUEL DE MOSES HENRIQUES⁶, MOSES HENRIQUES⁵, DAVID HENRIQUES⁴, MOSHE (MOSES) HENRIQUES³, DANIEL HENRIQUES², ? (THE SHEPHARDI) HENRIQUES¹*) was born 27 Jun 1860 in Aldgate Middlesex London England, and died 10 Nov 1936. He married JANE DAVIS 06 Feb 1881 in London, England, daughter of MOSES DAVIS and LIZZIE CANTOR. She was born 11 May 1862 in Whitechapel, London, England.

Children of BENJAMIN VALENTINE and JANE DAVIS are:

79. i. MICHAEL (ISHMAIL) DAVIS⁹ VALENTINE, b. Oct 1895, Aldgate.
- ii. CATHERINE VALENTINE, b. Abt. 1882, Aldgate.
- iii. EMANUEL JACOB VALENTINE, b. Abt. 1894, Aldgate.
- iv. ISAAC VALENTINE, b. Abt. 1882, Aldgate.
- v. JULIA VALENTINE, b. Abt. 1890, Aldgate.
- vi. MOSES VALENTINE, b. Abt. 1888, Aldgate.
- vii. REBECCA VALENTINE, b. Abt. 1892, Aldgate.

43. ALFRED⁸ VALENTINE (*ISAAC HENRIQUES⁷, EMANUEL DE MOSES HENRIQUES⁶, MOSES HENRIQUES⁵, DAVID HENRIQUES⁴, MOSHE (MOSES) HENRIQUES³, DANIEL HENRIQUES², ? (THE SHEPHARDI) HENRIQUES¹*)

Child of ALFRED VALENTINE is:

- i. MANNY⁹ VALENTINE, m. ADELAIDE ?.

44. JOSEPH EMANUEL⁸ VALENTINE (*ISAAC HENRIQUES⁷, EMANUEL DE MOSES HENRIQUES⁶, MOSES HENRIQUES⁵, DAVID HENRIQUES⁴, MOSHE (MOSES) HENRIQUES³, DANIEL HENRIQUES², ? (THE SHEPHARDI) HENRIQUES¹*) was born 1838 in Aldgate, London, England, and died 1877 in London. He married REBECCA NUNES MARTINES 09 Jul 1862 in London, daughter of ISAAC MARTINES and EMILY ?. She was born 27 Nov 1838, and died 1871 in London.

Children of JOSEPH VALENTINE and REBECCA MARTINES are:

- i. JULIA⁹ VALENTINE, b. 1862, Aldgate, London, England.
- ii. BETSY VALENTINE, b. 1863, Aldgate, London, England.
- iii. ABRAHAM VALENTINE, b. 1865, Mile End, Middlesex, England.
- iv. LEAH VALENTINE, b. 1868, Mile End, Middlesex, England.
- v. MARION VALENTINE, b. 1870, Mile End, Middlesex, England.

45. SOPHIA (ZIPORAH)⁸ VALENTINE (*ISAAC HENRIQUES⁷, EMANUEL DE MOSES HENRIQUES⁶, MOSES HENRIQUES⁵, DAVID HENRIQUES⁴, MOSHE (MOSES) HENRIQUES³, DANIEL HENRIQUES², ? (THE SHEPHARDI) HENRIQUES¹*) was born 14 Sep 1858 in Aldgate, Middlesex, England. She married REUBEN ISAACS 1881 in London, son of ISAAC ISAACS and PHOEBE JACOBS. He was born 1854 in Spitalfields Middlesex London England.

Children of SOPHIA VALENTINE and REUBEN ISAACS are:

- i. ABRAHAM⁹ ISAACS, b. 1884, Spitalfields Middlesex London England.
- ii. JULIA ISAACS, b. 1887, Spitalfields Middlesex London England.
- iii. JOHN ISAACS, b. 1891, Spitalfields Middlesex London England.
- iv. FRANCES ISAACS, b. 1898, Spitalfields Middlesex London England.

46. JANE (JAE) HENRIQUES⁸ VALENTINE (*ISAAC HENRIQUES⁷, EMANUEL DE MOSES HENRIQUES⁶, MOSES HENRIQUES⁵, DAVID HENRIQUES⁴, MOSHE (MOSES) HENRIQUES³, DANIEL HENRIQUES², ? (THE SHEPHARDI) HENRIQUES¹*) was born 24 Jan 1855 in London, England. She married ELIAS ABENDANA 21 Mar 1880 in Bevis Marks, London City Middlesex London England, son of JOHN ABENDANA and CATHERINE HYAMS. He was born 29 Jun 1854 in Whitechapel Middlesex London England.

Children of JANE VALENTINE and ELIAS ABENDANA are:

- i. JOHN⁹ ABENDANA, b. Abt. 1880, Whitechapel Middlesex London England.
- ii. ISAAC ABENDANA, b. Abt. 1882, Whitechapel Middlesex London England.
- iii. KATHERINE ABENDANA, b. Abt. 1883, Whitechapel Middlesex London England.
- iv. RICHARD (RASHAD) ABENDANA, b. Abt. 1888, Whitechapel Middlesex London England.
- v. RACHAEL ABENDANA, b. Abt. 1888, London, England.
- vi. REBECCA ABENDANA, b. Abt. 1891, Whitechapel Middlesex London England.

47. LEAH HENRIQUES⁸ VALENTINE (*ISAAC HENRIQUES⁷, EMANUEL DE MOSES HENRIQUES⁶, MOSES HENRIQUES⁵, DAVID HENRIQUES⁴, MOSHE (MOSES) HENRIQUES³, DANIEL HENRIQUES², ? (THE SHEPHARDI) HENRIQUES¹*) was born 31 Mar 1846 in Aldgate London Middlesex England, and died 1901. She married MICHAEL MITCHELL 01 Dec 1869 in London England, son of HYAM MITCHELL and EVE LIPMAN. He was born Dec 1843 in Whitechapel London England, and died Mar 1908 in Whitechapel London England.

Children of LEAH VALENTINE and MICHAEL MITCHELL are:

80. i. NATHAN⁹ MITCHELL, b. Jun 1862, Whitechapel London England.
- ii. JULIA MITCHELL, b. Dec 1873, London City England.
- iii. BENJAMIN MITCHELL, b. Sep 1875, Aldgate London England.
- iv. MICHAEL MITCHELL, b. Jun 1879, London City England.
- v. SARAH MITCHELL, b. 1882, Aldgate London England.
- vi. REBECCA MITCHELL, b. 1884, Aldgate London England.
- vii. HYAM MITCHELL, b. Jun 1887, Mile End London England.
- viii. EVA MITCHELL, b. Jun 1889, Mile End London England.

48. CAROLINE (KANANDELA) HENRIQUES⁸ VALENTINE (*ISAAC HENRIQUES⁷, EMANUEL DE MOSES HENRIQUES⁶, MOSES HENRIQUES⁵, DAVID HENRIQUES⁴, MOSHE (MOSES) HENRIQUES³, DANIEL HENRIQUES², ? (THE SHEPHARDI) HENRIQUES¹*) was born 16 Dec 1852 in Aldgate Middlesex London England. She married JACOB (JACK) SOLOMON JOEL 1880 in London City Middlesex London England, son of SOLOMON JOEL and PHOEBE LAZARUS. He was born 1852 in Bishopsgate, London, England, and died 1901 in Whitechapel Middlesex London England.

Children of CAROLINE VALENTINE and JACOB JOEL are:

- i. SOLOMON⁹ JOEL, b. 21 Oct 1881, Aldgate London Middlesex England.
- ii. ISAAC JOEL, b. Abt. 1884, Aldgate London Middlesex England.
- iii. PHOEBE JOEL, b. Abt. 1886, Aldgate London Middlesex England.

49. ABRAHAM HENRIQUES⁸ VALENTINE (*ISAAC HENRIQUES⁷, EMANUEL DE MOSES HENRIQUES⁶, MOSES HENRIQUES⁵, DAVID HENRIQUES⁴, MOSHE (MOSES) HENRIQUES³, DANIEL HENRIQUES², ? (THE SHEPHARDI) HENRIQUES¹*) was born 29 Jan 1842 in Aldgate, Middlesex, England, and died 22 Feb 1929 in Stepney, London. He married (1) MARION HART. He married (2) ELIZABETH (BATHSHEBA) HYAMS 14 Feb 1866 in Bevis Marks London City, daughter of JACOB HYAMS and CATHERINE DE SOYES. She was born 1843 in Whitechapel, Middlesex, England.

Children of ABRAHAM VALENTINE and ELIZABETH HYAMS are:

- i. JULIA⁹ VALENTINE, b. 18 Apr 1866, London England.
81. ii. CATHERINE VALENTINE, b. Abt. 1868, London England.
82. iii. ISAAC HENRIQUES VALENTINE, b. 29 Sep 1869, St Botolphs Middlesex London England.
83. iv. REBECCA VALENTINE, b. Abt. 1871, London England; d. 1907, Whitechapel Middlesex London England.
- v. LEAH (LILY) VALENTINE, b. Abt. 1873, St Botolphs, Middlesex, London, England; m. HENRY (HARRY) BURNSTEIN, 1899, London, England.
- vi. CAROLINE VALENTINE, b. Abt. 1876, St Botolphs Middlesex London England.
84. vii. JANE (JEAN) VALENTINE, b. Abt. 1877, St Botolphs Middlesex London England.
85. viii. SOPHIA VALENTINE, b. Abt. 1878, St Botolphs Middlesex London England.
- ix. ABIGAIL VALENTINE, b. Abt. 1879, St Botolphs Middlesex London England.
- x. JACOB VALENTINE, b. 05 Feb 1881, St Botolphs Middlesex London England.
86. xi. ANNIE VALENTINE, b. Abt. 1885, St Botolphs Middlesex London England.
- xii. EMANUEL VALENTINE, b. Abt. 1887, St Botolphs Middlesex London England.

50. REBECCA HENRIQUES⁸ VALENTINE (*ISAAC HENRIQUES⁷, EMANUEL DE MOSES HENRIQUES⁶, MOSES HENRIQUES⁵, DAVID HENRIQUES⁴, MOSHE (MOSES) HENRIQUES³, DANIEL HENRIQUES², ? (THE SHEPHARDI) HENRIQUES¹*) was born 16 Jan 1844 in Aldgate Middlesex London England, and died 24 May 1915. She married DAVID DANIEL MOSS 05 Jun 1867 in London City Middlesex London England. He was born Abt. 1847 in Marylebone, London, England.

Children of REBECCA VALENTINE and DAVID MOSS are:

87. i. KATE⁹ MOSS, b. Abt. 1869, Algate, London, England.
- ii. JULIA MOSS, b. Abt. 1870, Bethnal Green London England.
- iii. JANE MOSS, b. Abt. 1875, Bethnal Green London England; m. ? PATLANSKY.
- iv. NELLY MOSS, b. Abt. 1879, Bethnal Green London England.
- v. ELIAS MOSS, b. Abt. 1882, Bethnal Green London England; d. 1968.
- vi. ROBERT ISAAC MOSS, b. Abt. 1883, Bethnal Green London England.

51. SARAH CONSTANCE ENRIQUES⁸ VALENTINE (*SAUL HENRIQUES⁷, EMANUEL DE MOSES HENRIQUES⁶, MOSES HENRIQUES⁵, DAVID HENRIQUES⁴, MOSHE (MOSES) HENRIQUES³, DANIEL HENRIQUES², ? (THE SHEPHARDI) HENRIQUES¹*) was born 17 Nov 1864 in London City, London, England, and died 1937 in London, Middlesex, England. She married WOOLF JOEL LEVY 1887, son of JOEL LEVY and HANNAH HARRIS. He was born Abt. 1859 in London, Middlesex, England, and died 11 Sep 1888 in London, Middlesex, England.

Children of SARAH VALENTINE and WOOLF LEVY are:

88. i. HANNAH⁹ LEVY, b. 08 Dec 1887, Bow, London, England; d. 1978, Rhode Island US.
- ii. JOEL LEVY, b. Abt. 1893, Bow, London, England.
- iii. KATHERINE (KATIE) LEVY, b. Abt. 1890, Bow, London, England.
- iv. ELIZABETH (LILIAN) LEVY, b. 1895, Bow, London, England.
- v. PHOEBE LEVY, b. Abt. 1898, Bow, London, England.
- vi. ALEXANDRA ESTHER LEVY, b. Abt. 1898, Bow, London, England.

52. SAUL HENRIQUES⁸ VALENTINE (*SAUL HENRIQUES⁷, EMANUEL DE MOSES HENRIQUES⁶, MOSES HENRIQUES⁵, DAVID HENRIQUES⁴, MOSHE (MOSES) HENRIQUES³, DANIEL HENRIQUES², ? (THE SHEPHARDI) HENRIQUES¹*) was born 16 Sep 1855 in St. Botolph, and died 15 Sep 1937 in Croydon, Surrey. He married ELIZABETH MYERS 1886 in Paddington, London, England. She was born 23 Aug 1858 in Whitechapel, London, England, and died 1949 in Croydon, Surrey, England.

Children of SAUL VALENTINE and ELIZABETH MYERS are:

- i. MAURICE SAUL⁹ VALENTINE, b. 1887, London, England; m. LEONORA GREENBERG, 1926, Lambeth, London, England; b. 1887.
- ii. VIOLET SARAH VALENTINE, b. 29 Dec 1890, London, England; m. JOHN COLLINS, 1923, London, England; b. Abt. 1885; d. 1939.
- 89. iii. CECIL SAUL VALENTINE, b. 13 Feb 1892, Kennington, Lambeth, London, England.

53. KATE (KETURA)⁸ VALENTINE (*SAUL HENRIQUES⁷, EMANUEL DE MOSES HENRIQUES⁶, MOSES HENRIQUES⁵, DAVID HENRIQUES⁴, MOSHE (MOSES) HENRIQUES³, DANIEL HENRIQUES², ? (THE SHEPHARDI) HENRIQUES¹*) was born 23 Jul 1860 in East London, Middlesex, England, and died 1906 in West Ham, Essex, England. She married SAMUEL MAGNUS 1880 in London, Middlesex, England. He was born 1854 in Whitechapel, Middlesex, England, and died 1925 in Poplar, London, England.

Children of KATE VALENTINE and SAMUEL MAGNUS are:

- 90. i. RALPH VALENTINE⁹ MAGNUS, b. 10 Sep 1880, Poplar, London, England; d. 12 Oct 1946, Ilford, Romford, Essex, England.
- 91. ii. REBECCA SARAH MAGNUS, b. 08 Mar 1885, Poplar, London, England; d. 30 Oct 1960, East Ham, London, England.
- iii. VALENTINE PHOEBE MAGNUS, b. 27 Aug 1887, Bow, Tower Hamlets, Middlesex, England; d. 1975, Hendon, Middlesex, England; m. JOHN SIDNEY GILBERT, 1907, Greenwich, London, England; b. 16 Jan 1884, Holborn, London City, England; d. 1941, Hackney, London, England.
- 92. iv. SARAH MAGNUS, b. 1888, Poplar, London, England.
- 93. v. SAUL MAGNUS, b. 23 Aug 1891, Poplar, London, England; d. 1966, Barking, London, England.
- vi. BARNETT MAGNUS, b. 07 May 1893, Poplar, London, England; d. 1978, Newham, London, England.
- 94. vii. WOOLFE (WALTER) MAGNUS, b. 05 Mar 1894, Poplar, London, England; d. 1960, Wallingford, Berkshire, England.
- 95. viii. JOHN WESLEY (JACK) MAGNUS, b. 17 Aug 1897, Poplar, London, England; d. 1969, Redbridge, London, England.
- 96. ix. RUSSEL HYMAN MAGNUS, b. 28 Mar 1899, West Ham, Essex, England; d. 24 Apr 1987, Auckland, New Zealand.

54. HANNAH⁸ VALENTINE (*MOSES HENRIQUES⁷, EMANUEL DE MOSES HENRIQUES⁶, MOSES HENRIQUES⁵, DAVID HENRIQUES⁴, MOSHE (MOSES) HENRIQUES³, DANIEL HENRIQUES², ? (THE SHEPHARDI) HENRIQUES¹*) was born Abt. 1822 in Whitechapel, London. She married WILLIAM HEAP 19 Oct 1844 in Islington.

Child of HANNAH VALENTINE and WILLIAM HEAP is:

- i. HANNAH⁹ HEAP, b. 1846, St Lukes.

55. EMANUEL HENRIQUES⁸ VALENTINE (*ABRAHAM HENRIQUES⁷, EMANUEL DE MOSES HENRIQUES⁶, MOSES HENRIQUES⁵, DAVID HENRIQUES⁴, MOSHE (MOSES) HENRIQUES³, DANIEL HENRIQUES², ? (THE SHEPHARDI) HENRIQUES¹*) was born 23 Apr 1834 in London, Middlesex, England, and died 1877 in Mile End Old Town. He married (1) FANNY WOOLF 19 Jun 1861 in St. George, London, England. He married (2) REBECCA MARTIN 09 Jul 1862 in London, England, daughter of ISAAC DE ABRAHAM MARTIN. She was born Abt. 1838 in London, Middlesex, England, and died 1870 in St. Pancras, London.

Children of EMANUEL VALENTINE and REBECCA MARTIN are:

- i. JULIA⁹ VALENTINE, b. Abt. 1862, Mile End Old Town.
- ii. BETSY VALENTINE, b. Abt. 1864, Mile End Old Town.
- iii. ABRAHAM VALENTINE, b. Abt. 1865, Mile End Old Town.
- iv. LEAH VALENTINE, b. Abt. 1868, Mile End Old Town.
- v. MARIAN VALENTINE, b. Abt. 1869, Mile End Old Town.

56. AMELIA HENRIQUES⁸ VALENTINE (*ABRAHAM HENRIQUES⁷, EMANUEL DE MOSES HENRIQUES⁶, MOSES HENRIQUES⁵, DAVID HENRIQUES⁴, MOSHE (MOSES) HENRIQUES³, DANIEL HENRIQUES², ? (THE SHEPHARDI) HENRIQUES¹*) was born 1842 in London, Middlesex, England, and died Dec 1885 in Liverpool, Lancashire. She married ADOLF NIEMAN 16 Nov 1859 in London, England. He was born 1832 in Hungary, Mistoly.

Children of AMELIA VALENTINE and ADOLF NIEMAN are:

97. i. JACOB⁹ NIEMAN, b. 1860, Brighton, Sussex.
98. ii. ELIZABETH NIEMAN, b. 1864, Brighton, Sussex.
- iii. BELLA NIEMAN, b. 1866, Brighton, Sussex.
- iv. HANNAH ANNIE NIEMAN, b. 1869, Brighton, Sussex.
- v. REBECCA NIEMAN, b. 1871, Brighton, Sussex.
- vi. ELIAS NIEMAN, b. 1877, Liverpool, Lancashire.

57. SAUL HENRIQUES⁸ VALENTINE (*ABRAHAM HENRIQUES⁷, EMANUEL DE MOSES HENRIQUES⁶, MOSES HENRIQUES⁵, DAVID HENRIQUES⁴, MOSHE (MOSES) HENRIQUES³, DANIEL HENRIQUES², ? (THE SHEPHARDI) HENRIQUES¹*) was born 07 Feb 1844 in London, Middlesex, England. He married (1) SARAH RUSSELL 14 Jun 1854 in Bishopsgate, London, London, England. He married (2) SARAH ORNSTEIN 24 Jun 1868 in 16 Wood Street, Spitalfields, London, England, daughter of PHINEAS ORNSTEIN and ADELAIDE SAMUEL. She was born 1845 in London, Middlesex, England.

Children of SAUL VALENTINE and SARAH ORNSTEIN are:

- i. ABRAHAM HENRIQUES⁹ VALENTINE, b. 18 Mar 1869, London, Middlesex, England; m. REBECCA CORPER, 12 Feb 1890, Manhattan, NY; b. London.
- ii. SARAH HENRIQUES VALENTINE, b. 17 Nov 1864, London, Middlesex, England.
- iii. ADELAIDE HENRIQUES VALENTINE, b. Abt. 1871, London, Middlesex, England.
- iv. JULIA HENRIQUES VALENTINE, b. Abt. 1872, London, Middlesex, England.
- v. REBECCA HENRIQUES VALENTINE, b. Abt. 1875, London, Middlesex, England.
- vi. LEAH HENRIQUES VALENTINE, b. Abt. 1876, London, Middlesex, England.
- vii. ESTER HENRIQUES VALENTINE, b. Abt. 1878, London, Middlesex, England.
- viii. SOPHIA HENRIQUES VALENTINE, b. Abt. 1880, London, Middlesex, England.
- ix. PHINEAS HENRIQUES VALENTINE, b. Abt. 1880, London, Middlesex, England.

58. EMANUEL⁸ VALENTINE (*BENJAMIN HENRIQUES⁷, EMANUEL DE MOSES HENRIQUES⁶, MOSES HENRIQUES⁵, DAVID HENRIQUES⁴, MOSHE (MOSES) HENRIQUES³, DANIEL HENRIQUES², ? (THE SHEPHARDI) HENRIQUES¹*) was born 20 Sep 1848 in Middlesex, London. He married ELLEN YATES. She was born 1855 in Shoreditch, London.

Children of EMANUEL VALENTINE and ELLEN YATES are:

- i. EMANUEL⁹ VALENTINE, b. 1875, Hoxton, Shoreditch, London.
- ii. ESTHER M VALENTINE, b. 1876, Hoxton, Shoreditch, London.
- iii. BENJAMIN VALENTINE, b. 1880, Hoxton, Shoreditch, London.
- iv. JOSEPH VALENTINE, b. Abt. 1875.

59. SOLOMON DA SILVA⁸ SOLIS (*JACOB DA SILVA⁷, BENVENIDA DE ISAAC HENRIQUES⁶ VALENTINE, MOSES HENRIQUES⁵, DAVID HENRIQUES⁴, MOSHE (MOSES) HENRIQUES³, DANIEL HENRIQUES², ? (THE SHEPHARDI) HENRIQUES¹*) was born 23 Mar 1819 in Wilmington, Delaware, and died 22 Jun 1854 in New York. He married ELLEN WATERLOO SAMUELS.

Child of SOLOMON SOLIS and ELLEN SAMUELS is:

- i. JACOB FONSECA DA SILVA⁹ SOLIS, b. 09 Jan 1854, New York, New York; d. 23 Dec 1894, New York, New York.

60. DAVID HAYS⁸ SOLIS (*JACOB DA SILVA⁷, BENVENIDA DE ISAAC HENRIQUES⁶ VALENTINE, MOSES HENRIQUES⁵, DAVID HENRIQUES⁴, MOSHE (MOSES) HENRIQUES³, DANIEL HENRIQUES², ? (THE SHEPHARDI) HENRIQUES¹*) was born 28 May 1822 in Mt. Pleasant, Westchester Co., New York, and died 30 Nov 1882 in Philadelphia, Pennsylvania. He married ELVIRA NATHAN. She was born 1826 in New York, New York, and died 1912.

Children of DAVID SOLIS and ELVIRA NATHAN are:

- i. ESTHER ETTING⁹ SOLIS.
- ii. CHARITY SOLIS, b. 07 Aug 1853, Philadelphia, Pennsylvania, USA; d. 02 May 1905, Philadelphia, Pennsylvania, USA.
- iii. JACOB SOLOMON SOLIS, b. 07 Dec 1855; d. 31 Jul 1894.
- iv. ISAAC NATHAN SOLIS, b. 28 Nov 1857, Philadelphia, Pennsylvania, USA; d. 13 Feb 1909.
- v. EMILY GRACE SOLIS, b. 26 Nov 1859, Philadelphia, Pennsylvania; d. Philadelphia, Pennsylvania.
- vi. ELVIRA NATHAN SOLIS, b. Abt. 1860; d. 30 Nov 1953, New York City.
- vii. DAVID HAYS SOLIS, b. 18 Apr 1862, Philadelphia, Pennsylvania, USA; d. 1936.
- viii. SARAH NATHAN SOLIS, b. 10 Feb 1863, Philadelphia, Pennsylvania, USA; d. 1937, Mamaroneck, New York.
- ix. ALBERT BENJAMIN SOLIS, b. 31 Dec 1870, Philadelphia, Pennsylvania, USA; d. 1950.

61. BENVENIDA⁸ SOLIS (*JACOB DA SILVA*⁷, *BENVENIDA DE ISAAC HENRIQUES*⁶ VALENTINE, *MOSES HENRIQUES*⁵, *DAVID HENRIQUES*⁴, *MOSHE (MOSES) HENRIQUES*³, *DANIEL HENRIQUES*², ? (*THE SHEPHARDI) HENRIQUES*¹) was born 17 Jan 1813 in Mt. Pleasant, Westchester Co., New York, and died 15 Jan 1892 in New York. She married LEON MANESS RITTERBAND 28 Oct 1835 in New York. He was born 1809 in Poland, and died 28 Sep 1860 in New York.

Children of BENVENIDA SOLIS and LEON RITTERBAND are:

- i. JOSEPH⁹ RITTERBAND, b. 25 Nov 1838, New York.
- ii. CHARITY RITTERBAND, b. 17 Jan 1843, New York; d. 18 Jan 1857.
99. iii. JACOB SOLIS RITTERBAND, b. 26 Oct 1836, New York; d. 11 Jan 1896, New York.
100. iv. LUCIA MANESS RITTERBAND, b. 27 Sep 1840, New York; d. 10 Apr 1872.
101. v. SARAH (SALLY) MANESS RITTERBAND, b. 29 Mar 1846, New York, NY; d. 06 Dec 1915, New York.
102. vi. MOSES MANESS RITTERBAND, b. 28 Jan 1848, New York.
103. vii. DAVID SOLIS RITTERBAND, b. 18 Sep 1850, New York; d. 25 Dec 1926, New York.

62. JUDITH SIMHA⁸ SOLIS (*JACOB DA SILVA*⁷, *BENVENIDA DE ISAAC HENRIQUES*⁶ VALENTINE, *MOSES HENRIQUES*⁵, *DAVID HENRIQUES*⁴, *MOSHE (MOSES) HENRIQUES*³, *DANIEL HENRIQUES*², ? (*THE SHEPHARDI) HENRIQUES*¹) was born 17 May 1817 in Wilmington, Delaware, and died 13 Feb 1914 in Philadelphia, Pennsylvania. She married MYER DAVID COHEN.

Children of JUDITH SOLIS and MYER COHEN are:

- i. DR. JACOB DA SILVA⁹ SOLIS-COHEN, b. 28 Feb 1838, New York City; d. 1927, Philadelphia, Pennsylvania.
- ii. DR. SOLOMON DA SILVA SOLIS-COHEN, b. 01 Sep 1857, Philadelphia, Pennsylvania; d. 12 Jul 1948, Philadelphia, Pennsylvania.
104. iii. LEON DA SILVA SOLIS-COHEN, b. 16 Oct 1840, Philadelphia, Pennsylvania; d. 19 Sep 1884.

63. SARAH MIRIAM⁸ SOLIS (*JACOB DA SILVA*⁷, *BENVENIDA DE ISAAC HENRIQUES*⁶ VALENTINE, *MOSES HENRIQUES*⁵, *DAVID HENRIQUES*⁴, *MOSHE (MOSES) HENRIQUES*³, *DANIEL HENRIQUES*², ? (*THE SHEPHARDI) HENRIQUES*¹) was born 15 Oct 1824 in Mt. Pleasant, Westchester Co., New York, and died 02 May 1894 in New York. She married SOLOMON NUNES CARVALHO 15 Oct 1845 in Philadelphia, Pennsylvania. He was born 27 Apr 1815 in Charleston, South Carolina, and died 1897.

Children of SARAH SOLIS and SOLOMON CARVALHO are:

- i. DAVID NUNES⁹ CARVALHO, b. 29 Sep 1848, Philadelphia, Pennsylvania; d. 1925, New Rochelle, New York.
- ii. JACOB SOLIS CARVALHO, b. 23 Sep 1852, Charleston, West Virginia; d. 13 Mar 1937, Lawrence, Long Island, New York.
- iii. CHARITY SOLIS CARVALHO, b. 12 Apr 1853, Baltimore, Maryland; d. 05 Apr 1945, New Rochelle, New York.
- iv. SOLOMON SOLIS CARVALHO, b. Jan 1856, Baltimore, Maryland; d. 12 Apr 1942.

64. PHOEBE ELIZABETH⁸ SOLIS (*JACOB DA SILVA*⁷, *BENVENIDA DE ISAAC HENRIQUES*⁶ VALENTINE, *MOSES HENRIQUES*⁵, *DAVID HENRIQUES*⁴, *MOSHE (MOSES) HENRIQUES*³, *DANIEL HENRIQUES*², ? (*THE SHEPHARDI) HENRIQUES*¹) was born 30 Mar 1827 in Mt Pleasant, and died 30 Nov 1893 in Chews Landing, New Jersey. She married DAVID DE MOSES SARFATY 05 Feb 1851 in Philadelphia, Pennsylvania, USA. He was born 1828 in Jamaica, and died 08 Oct 1854.

Child of PHOEBE SOLIS and DAVID SARFATY is:

- i. MOSES DAVID⁹ SARFATY, b. 18 Oct 1851, New York, New York; d. 13 Mar 1923, Philadelphia, Pennsylvania, USA.

65. ALBIONA⁸ SOLIS (*DANIEL⁷, BENVENIDA DE ISAAC HENRIQUES⁶ VALENTINE, MOSES HENRIQUES⁵, DAVID HENRIQUES⁴, MOSHE (MOSES) HENRIQUES³, DANIEL HENRIQUES², ? (THE SHEPHARDI) HENRIQUES¹*) She married (1) JACOB (WASHINGTON) CROMLIEN. She married (2) DR. JOHN A. WARTENBY.

Child of ALBIONA SOLIS and JOHN WARTENBY is:

- i. IDA MAY⁹ WARTENBY.

66. SAMUEL⁸ VALENTINE (*SAMUEL⁷, DAVID HENRIQUES⁶, MOSES HENRIQUES⁵, DAVID HENRIQUES⁴, MOSHE (MOSES) HENRIQUES³, DANIEL HENRIQUES², ? (THE SHEPHARDI) HENRIQUES¹*) was born Jan 1835 in Brooklyn Ward 4, Kings Cty, New York, and died 10 Sep 1916 in Brooklyn, Kings, New York, United States. He married MARGARET EVELYN DAVY 1872, daughter of ROBERT DAVY and ELIZA ROSE. She was born Jul 1844 in Brooklyn Ward 4, Kings Cty, New York, and died 27 Aug 1930 in White Plains, New York, USA.

Children of SAMUEL VALENTINE and MARGARET DAVY are:

105. i. LILIAN MAE⁹ VALENTINE, b. 29 Mar 1873, Brooklyn Ward 4, Kings Cty, New York; d. 11 Aug 1969, Charlottesville, Albemarle, Virginia, USA.
- ii. EVA ROSE VALENTINE, b. Aug 1874, Brooklyn, Kings, New York, United States.
- iii. GRACE E VALENTINE, b. 08 Feb 1876, Brooklyn Ward 4, Kings Cty, New York.
- iv. SAMUEL DAVY VALENTINE, b. 26 Jul 1880, Brooklyn Ward 4, Kings Cty, New York.
- v. CHARLES KELLER VALENTINE, b. 28 May 1883, Brooklyn Ward 4, Kings Cty, New York.

67. LEAH⁸ BERLIN (*REBECCA HENRIQUES⁷ VALENTINE, DAVID HENRIQUES⁶, MOSES HENRIQUES⁵, DAVID HENRIQUES⁴, MOSHE (MOSES) HENRIQUES³, DANIEL HENRIQUES², ? (THE SHEPHARDI) HENRIQUES¹*) was born 1816 in New York, and died 15 Jan 1854 in New York. She married HENRY GUTTMAN 26 Dec 1832.

Children of LEAH BERLIN and HENRY GUTTMAN are:

- i. JACOB⁹ GUTTMAN, b. 06 Sep 1834.
- ii. REBECCA GUTTMAN, b. 28 Oct 1835.
- iii. ELIZABETH GUTTMAN, b. 09 Apr 1837.
- iv. MOSES GUTTMAN, b. 08 Jul 1839.
- v. JOSEPH GUTTMAN, b. 04 Jun 1845.

68. HANNAH HENRIQUES⁸ VALENTINE (*JACOB (DE ELIAS) HENRIQUES⁷, ELIAS HENRIQUES⁶, MOSES HENRIQUES⁵, DAVID HENRIQUES⁴, MOSHE (MOSES) HENRIQUES³, DANIEL HENRIQUES², ? (THE SHEPHARDI) HENRIQUES¹*) was born 07 Jan 1837 in Shoreditch, London, and died 06 Jul 1900. She married SOLOMON ISAACS 12 Dec 1866 in Bevis Marks.

Children of HANNAH VALENTINE and SOLOMON ISAACS are:

- i. AARON ALFRED⁹ ISAACS, b. 168.
- ii. AMELIA ISAACS, b. 1870.

69. HANNAH HENRIQUES⁸ VALENTINE (*SAUL HENRIQUES⁷, ELIAS HENRIQUES⁶, MOSES HENRIQUES⁵, DAVID HENRIQUES⁴, MOSHE (MOSES) HENRIQUES³, DANIEL HENRIQUES², ? (THE SHEPHARDI) HENRIQUES¹*) was born 13 Feb 1839 in Shoreditch, London, and died 1909 in Lambeth. She married (1) JOHN HARRISON POWELL 1859. He was born 1839, and died 1861. She married (2) WILLIAM DEAKIN BECKET 08 May 1867. He was born 1839.

Child of HANNAH VALENTINE and JOHN POWELL is:

- i. LAURA VALENTINE⁹ POWELL, b. 1861; d. 1899.

Children of HANNAH VALENTINE and WILLIAM BECKET are:

- ii. WILLIAM VALENTINE⁹ BECKET, b. 1868.
- iii. RICHARD ALFRED BECKET, b. 1870.
- iv. MIRIAM ANNE BECKET, b. 1873.
106. v. SOPHIA REBECCA BECKET, b. 1874; d. 1946.
- vi. MINNIE OCTAVOA BECKET, b. 1876.
- vii. ASHTON CLEMENT BECKET, b. 1878.
- viii. CLARA ADA BECKET, b. 1881.
- ix. BEATRICE MAUDE BECKET, b. 1883.
- x. ARTHUR SNOWDEN BECKET, b. 1884.

70. JOSEPH⁸ VALENTINE (*JOSEPH MOSES⁷, DAVID (DE JEHOShUA) HENRIQUES⁶, JEHOShUA HENRIQUES⁵, DAVID HENRIQUES⁴, MOSHE (MOSES) HENRIQUES³, DANIEL HENRIQUES², ? (THE SHEPHARDI) HENRIQUES¹*) was born 08 Feb 1842 in Hoxton Old Town, Middlesex, and died 1913. He married (1) MARY ANN GARDNER. She was born 1851 in Spitalfields, Middlesex, and died 1883. He married (2) JULIA (SIMCHA) BITTAN 15 Feb 1864 in Registry Office, Shoreditch. She was born 1844 in Bethnal Green, London, and died Bef. 1875.

Child of JOSEPH VALENTINE and MARY GARDNER is:

107. i. JOSEPH GARDNER⁹ VALENTINE, b. 18 Feb 1877, Dalston, Hackney, Middlesex; d. Aft. 1912, USA.

Generation No. 9

71. MARGARET MIRIAM (MAY)⁹ VALENTINE (*COLEMAN (COLONIMUS) HENRIQUES⁸, ISAAC HENRIQUES⁷, EMANUEL DE MOSES HENRIQUES⁶, MOSES HENRIQUES⁵, DAVID HENRIQUES⁴, MOSHE (MOSES) HENRIQUES³, DANIEL HENRIQUES², ? (THE SHEPHARDI) HENRIQUES¹*) was born 07 Jan 1903 in Mile End Road, London, England, and died 02 Sep 1980 in Wellington. She married (1) FREDERICK JOHN HARRIS 19 Feb 1921 in The Register Office, West Ham, London England, son of CHARLES HARRIS and MARTHA CAPPI-HUNTINGDON. He was born 15 Jun 1896 in 3 Lautrauc Rd., Stepney, London, England, and died 17 Jun 1976 in Palmerston North. She married (2) ALFRED JOHN WING 1944 in New Zealand, son of ALFRED WING and GRACE ?. He was born 06 May 1909 in Thanet, Margate, Kent, and died 1990 in NZ.

Children of MARGARET VALENTINE and FREDERICK HARRIS are:

108. i. NORMA MARGARET LOUISA¹⁰ HARRIS, b. 12 Jan 1930, Alexandra Nursing Home, 28 Hanson Street, Newtown, Wellington; d. 11 Dec 2011, St Andrews Hospital, Glendowie, Auckland.

109. ii. FREDERICK CHARLES HARRIS, b. 07 Jul 1922, Mile End Rd, Stepney, London; d. 05 Jun 1999, 53 Fairs Rd., Palmerston North.

72. ARTHUR ISAAC⁹ VALENTINE (*COLEMAN (COLONIMUS) HENRIQUES⁸, ISAAC HENRIQUES⁷, EMANUEL DE MOSES HENRIQUES⁶, MOSES HENRIQUES⁵, DAVID HENRIQUES⁴, MOSHE (MOSES) HENRIQUES³, DANIEL HENRIQUES², ? (THE SHEPHARDI) HENRIQUES¹*) was born 10 Apr 1885 in London City Middlesex London England, and died 1948 in Hackney, London. He married HILDA GERTRUDE LAWRENCE 1916 in Basford, Notts, daughter of WILLIAM LAWRENCE and ELLEN HAINES. She was born 03 Dec 1895 in Ilkeston, Derbyshire, and died 1972 in Chingford, London.

Children of ARTHUR VALENTINE and HILDA LAWRENCE are:

110. i. WILLIAM COLEMAN¹⁰ VALENTINE, b. 26 May 1918, Basford, Notts; d. 1976, Waltham Forest, London.

ii. JACK W VALENTINE, b. 1924, West Ham, London; d. 1926, West Ham, London.

111. iii. ROBERT (BOB) JOSEPH VALENTINE, b. 23 Mar 1932, Epping.

73. JULIE LOUISA⁹ VALENTINE (*COLEMAN (COLONIMUS) HENRIQUES⁸, ISAAC HENRIQUES⁷, EMANUEL DE MOSES HENRIQUES⁶, MOSES HENRIQUES⁵, DAVID HENRIQUES⁴, MOSHE (MOSES) HENRIQUES³, DANIEL HENRIQUES², ? (THE SHEPHARDI) HENRIQUES¹*) was born 22 Aug 1888 in Maidment St, Bethnal Green, London, and died 01 Jan 1971. She married WILLIAM FRANCIS 16 Apr 1911 in West Ham, London, son of HENRY FRANCIS and NELLY ?. He was born 29 Mar 1889 in Norfolk, and died 17 Dec 1945 in 180 Meads Lane, Ilford South.

Children of JULIE VALENTINE and WILLIAM FRANCIS are:

112. i. ALFRED WILLIAM¹⁰ FRANCIS, b. 22 Mar 1916, West Ham, Essex, London; d. 01 Mar 1997.

113. ii. LOUISE JULIE FRANCIS, b. 13 Jan 1912, West Ham, London; d. 29 Nov 2009.

74. JACOB HENRY (JACK)⁹ VALENTINE (*COLEMAN (COLONIMUS) HENRIQUES⁸, ISAAC HENRIQUES⁷, EMANUEL DE MOSES HENRIQUES⁶, MOSES HENRIQUES⁵, DAVID HENRIQUES⁴, MOSHE (MOSES) HENRIQUES³, DANIEL HENRIQUES², ? (THE SHEPHARDI) HENRIQUES¹*) was born 29 Jan 1895 in Mile End, London, England, and died 20 Sep 1984 in Hendon, Middx. He married REBECCA (BECKY) MITCHELL 1917 in London City. She was born 1891, and died 1961.

Child of JACOB VALENTINE and REBECCA MITCHELL is:

- i. QUEENIE L¹⁰ VALENTINE, b. 1918, Whitechapel, London.

75. JANE DAVIS⁹ VALENTINE (*COLEMAN (COLONIMUS) HENRIQUES⁸, ISAAC HENRIQUES⁷, EMANUEL DE MOSES HENRIQUES⁶, MOSES HENRIQUES⁵, DAVID HENRIQUES⁴, MOSHE (MOSES) HENRIQUES³, DANIEL HENRIQUES², ? (THE SHEPHARDI) HENRIQUES¹*) was born 1898 in Mile End London England, and died 1987 in Chelmsford, Essex. She married GEORGE EDWARD WILLIAMS 1918 in Mile End London England.

Children of JANE VALENTINE and GEORGE WILLIAMS are:

114. i. JACK HERBERT (JACKIE)¹⁰ WILLIAMS, b. 1924, Mile End London England.
115. ii. GILBERT DOUGLAS WILLIAMS, b. 1919, Holborn, London.
116. iii. DORIS NELLIE WILLIAMS, b. 1922, Mile End London England.

76. ALFRED (ABRAHAM JOHN)⁹ VALENTINE (*COLEMAN (COLONIMUS) HENRIQUES⁸, ISAAC HENRIQUES⁷, EMANUEL DE MOSES HENRIQUES⁶, MOSES HENRIQUES⁵, DAVID HENRIQUES⁴, MOSHE (MOSES) HENRIQUES³, DANIEL HENRIQUES², ? (THE SHEPHARDI) HENRIQUES¹*) was born Abt. 1895 in Farmbridge Rd, Bethnal Green, London, England. He married GLADYS LOUISE ADEY 1916 in West Ham, London, daughter of HENRY ADEY and HARRIET BALL. She was born 15 Nov 1894 in Stepney, London, England.

Children of ALFRED VALENTINE and GLADYS ADEY are:

117. i. GEORGE COLEMAN¹⁰ VALENTINE, b. 22 Dec 1922, West Ham, London; d. Jan 2005, Chiltern, Buckinghamshire.
- ii. CYRIL A H VALENTINE, b. 1917, West Ham, London; d. Feb 1988, Enfield, Middlesex.

77. EMANUEL JOSEPH⁹ VALENTINE (*COLEMAN (COLONIMUS) HENRIQUES⁸, ISAAC HENRIQUES⁷, EMANUEL DE MOSES HENRIQUES⁶, MOSES HENRIQUES⁵, DAVID HENRIQUES⁴, MOSHE (MOSES) HENRIQUES³, DANIEL HENRIQUES², ? (THE SHEPHARDI) HENRIQUES¹*) was born 1900 in Mile End Rd, and died 1967. He married GLADYS HUNT 1926 in West Ham, London.

Child of EMANUEL VALENTINE and GLADYS HUNT is:

- i. GORDON J W¹⁰ VALENTINE, b. 1929, West Ham, London.

78. FANNY⁹ EMANUEL (*CATHERINE (KATE) HENRIQUES⁸ VALENTINE, ISAAC HENRIQUES⁷, EMANUEL DE MOSES HENRIQUES⁶, MOSES HENRIQUES⁵, DAVID HENRIQUES⁴, MOSHE (MOSES) HENRIQUES³, DANIEL HENRIQUES², ? (THE SHEPHARDI) HENRIQUES¹*) was born 1878 in Westminster, London, England. She married MORRIS CROSS, son of PHILIP CROSS and JULIA ?. He was born Abt. 1876 in Whitechapel, London, England.

Children of FANNY EMANUEL and MORRIS CROSS are:

- i. PHILIP¹⁰ CROSS, b. Abt. 1900, Mile End, London, England.
- ii. LEWIS CROSS, b. Abt. 1901, Mile End, London, England.
- iii. JULIA CROSS, b. 1906, Poplar, London, England; m. ROY EARLY.
- iv. KITTY CROSS, b. 1912, Islington; m. ERIC GORDON RAWLINSON; b. 19 May 1913; d. May 1992.

79. MICHAEL (ISHMAIL) DAVIS⁹ VALENTINE (*BENJAMIN HENRIQUES⁸, ISAAC HENRIQUES⁷, EMANUEL DE MOSES HENRIQUES⁶, MOSES HENRIQUES⁵, DAVID HENRIQUES⁴, MOSHE (MOSES) HENRIQUES³, DANIEL HENRIQUES², ? (THE SHEPHARDI) HENRIQUES¹*) was born Oct 1895 in Aldgate.

Child of MICHAEL (ISHMAIL) DAVIS VALENTINE is:

118. i. PETER BENJAMIN¹⁰ VALENTINE.

80. NATHAN⁹ MITCHELL (*LEAH HENRIQUES⁸ VALENTINE, ISAAC HENRIQUES⁷, EMANUEL DE MOSES HENRIQUES⁶, MOSES HENRIQUES⁵, DAVID HENRIQUES⁴, MOSHE (MOSES) HENRIQUES³, DANIEL HENRIQUES², ? (THE SHEPHARDI) HENRIQUES¹*) was born Jun 1862 in Whitechapel London England. He married EVA ?. She was born 1869.

Children of NATHAN MITCHELL and EVA ? are:

- i. ROSE¹⁰ MITCHELL, b. Dec 1888, St. Pancras London England.
- ii. QUEENIE MITCHELL, b. Sep 1891, Lambeth London England.

81. CATHERINE⁹ VALENTINE (*ABRAHAM HENRIQUES⁸, ISAAC HENRIQUES⁷, EMANUEL DE MOSES HENRIQUES⁶, MOSES HENRIQUES⁵, DAVID HENRIQUES⁴, MOSHE (MOSES) HENRIQUES³, DANIEL HENRIQUES², ? (THE SHEPHARDI) HENRIQUES¹*) was born Abt. 1868 in London England. She married HYMAN MORDECAI TOURNOFF 1891 in London City Middlesex London England, son of JOSHUA TOURNOFF and REBECCA BARNARD. He was born Abt. 1862 in Sheffield, Yorkshire, England.

Children of CATHERINE VALENTINE and HYMAN TOURNOFF are:

- i. ABRAHAM¹⁰ TOURNOFF, b. Abt. 1895, Whitechapel Middlesex London England.
- ii. REBECCA TOURNOFF, b. Abt. 1896, London England.
- iii. BESSIE TOURNOFF, b. Abt. 1897, London England.
- iv. ELLA TOURNOFF, b. Abt. 1899, London England.
119. v. ALFRED TOURNOFF, b. Abt. 1894, Whitechapel Middlesex London England.

82. ISAAC HENRIQUES⁹ VALENTINE (*ABRAHAM HENRIQUES⁸, ISAAC HENRIQUES⁷, EMANUEL DE MOSES HENRIQUES⁶, MOSES HENRIQUES⁵, DAVID HENRIQUES⁴, MOSHE (MOSES) HENRIQUES³, DANIEL HENRIQUES², ? (THE SHEPHARDI) HENRIQUES¹*) was born 29 Sep 1869 in St Botolphs Middlesex London England. He married SARAH ISRAEL 18 May 1892 in Bevis Marks London City, daughter of JUDAH ISRAEL and LEAH HYAMS. She was born 1872 in Aldgate Middlesex London England.

Child of ISAAC VALENTINE and SARAH ISRAEL is:

- i. ALFRED¹⁰ VALENTINE, b. Abt. 1893.

83. REBECCA⁹ VALENTINE (*ABRAHAM HENRIQUES⁸, ISAAC HENRIQUES⁷, EMANUEL DE MOSES HENRIQUES⁶, MOSES HENRIQUES⁵, DAVID HENRIQUES⁴, MOSHE (MOSES) HENRIQUES³, DANIEL HENRIQUES², ? (THE SHEPHARDI) HENRIQUES¹*) was born Abt. 1871 in London England, and died 1907 in Whitechapel Middlesex London England. She married JOSEPH TOFF 1896 in London City Middlesex London England, son of JACOB TOFF and CAROLINE VAN BEER. He was born Abt. 1873 in Spitalfields Middlesex London England.

Notes for REBECCA VALENTINE:

Rebecca Valentine (d 1907) daughter of Abraham Valentine 'married out' (was a Sephardi Jew and married an Ashkenazi Jew)

Children of REBECCA VALENTINE and JOSEPH TOFF are:

120. i. JACOB (JACK)¹⁰ TOFF, b. Abt. 1898, Mile End, London, England.
121. ii. ELIZABETH TOFF, b. Abt. 1899, Mile End London England.
122. iii. ABRAHAM (ALFRED) TOFF, b. 31 Dec 1899, Stepney, London, England.
- iv. DAVID TOFF, b. 1901, Mile End London England.

84. JANE (JEAN)⁹ VALENTINE (*ABRAHAM HENRIQUES⁸, ISAAC HENRIQUES⁷, EMANUEL DE MOSES HENRIQUES⁶, MOSES HENRIQUES⁵, DAVID HENRIQUES⁴, MOSHE (MOSES) HENRIQUES³, DANIEL HENRIQUES², ? (THE SHEPHARDI) HENRIQUES¹*) was born Abt. 1877 in St Botolphs Middlesex London England. She married JACOB (JACK) COSTA 27 Aug 1901 in Bevis Marks, son of RAPHAEL COSTA. He was born 1877 in Spitalfields, London, and died 20 Sep 1955.

Child of JANE VALENTINE and JACOB COSTA is:

- i. RALPH EDWARD¹⁰ COSTA, b. 1902; d. 18 Nov 1903.

85. SOPHIA⁹ VALENTINE (*ABRAHAM HENRIQUES⁸, ISAAC HENRIQUES⁷, EMANUEL DE MOSES HENRIQUES⁶, MOSES HENRIQUES⁵, DAVID HENRIQUES⁴, MOSHE (MOSES) HENRIQUES³, DANIEL HENRIQUES², ? (THE SHEPHARDI) HENRIQUES¹*) was born Abt. 1878 in St Botolphs Middlesex London England. She married ANGEL AARONS 1904.

Child of SOPHIA VALENTINE and ANGEL AARONS is:

- i. KATE¹⁰ AARONS, b. Abt. 1906, Barnbury, London.

86. ANNIE⁹ VALENTINE (*ABRAHAM HENRIQUES⁸, ISAAC HENRIQUES⁷, EMANUEL DE MOSES HENRIQUES⁶, MOSES HENRIQUES⁵, DAVID HENRIQUES⁴, MOSHE (MOSES) HENRIQUES³, DANIEL HENRIQUES², ? (THE SHEPHARDI) HENRIQUES¹*) was born Abt. 1885 in St Botolphs Middlesex London England. She married JOSEPH TOFF 1913, son of JACOB TOFF and CAROLINE VAN BEER. He was born Abt. 1873 in Spitalfields Middlesex London England.

Child of ANNIE VALENTINE and JOSEPH TOFF is:

123. i. KATE (KITTY)¹⁰ TOFF, b. Abt. 1915.

87. KATE⁹ MOSS (*REBECCA HENRIQUES⁸ VALENTINE, ISAAC HENRIQUES⁷, EMANUEL DE MOSES HENRIQUES⁶, MOSES HENRIQUES⁵, DAVID HENRIQUES⁴, MOSHE (MOSES) HENRIQUES³, DANIEL HENRIQUES², ? (THE SHEPHARDI) HENRIQUES¹*) was born Abt. 1869 in Algate, London, England. She married HYAM GOLDSTEIN 1891 in London City Middlesex London England, son of ABRAHAM GOLDSTEIN and MARIA COHEN. He was born Abt. 1870 in Whitechapel Middlesex London England.

Children of KATE MOSS and HYAM GOLDSTEIN are:

- i. MARIA¹⁰ GOLDSTEIN, b. Abt. 1892, Finsbury London England.
- ii. DAVID GOLDSTEIN, b. Abt. 1895, South Africa.
- iii. ALFRED GOLDSTEIN, b. Abt. 1897, South Africa.

88. HANNAH⁹ LEVY (*SARAH CONSTANCE ENRIQUES⁸ VALENTINE, SAUL HENRIQUES⁷, EMANUEL DE MOSES HENRIQUES⁶, MOSES HENRIQUES⁵, DAVID HENRIQUES⁴, MOSHE (MOSES) HENRIQUES³, DANIEL HENRIQUES², ? (THE SHEPHARDI) HENRIQUES¹*) was born 08 Dec 1887 in Bow, London, England, and died 1978 in Rhode Island US. She married JOSEPH BAUM 12 Jul 1912 in West Ham, London, England, son of HENRY BAUM and KATE LEVENSTON. He was born Abt. 1886 in Manchester, Lancashire, England.

Children of HANNAH LEVY and JOSEPH BAUM are:

124. i. HENRY (HARRY)¹⁰ BAUM, b. 20 Apr 1912, Hackney, London, England; d. 14 Jul 1942, as a Prisoner of War of malaria in Changi prison, Singapore.
- ii. SALLY (SADIE) BAUM, b. 03 Apr 1914, Hackney, London, England; d. USA; m. (1) JACK MYERS; b. Abt. 1912; m. (2) PAUL FLANDRAKE; b. Abt. 1912.

89. CECIL SAUL⁹ VALENTINE (*SAUL HENRIQUES⁸, SAUL HENRIQUES⁷, EMANUEL DE MOSES HENRIQUES⁶, MOSES HENRIQUES⁵, DAVID HENRIQUES⁴, MOSHE (MOSES) HENRIQUES³, DANIEL HENRIQUES², ? (THE SHEPHARDI) HENRIQUES¹*) was born 13 Feb 1892 in Kennington, Lambeth, London, England. He married MAY ISAACS 1925 in Lambeth, London, England. She was born 16 Nov 1899 in St Giles, London, England.

Child of CECIL VALENTINE and MAY ISAACS is:

- i. BETTY Y¹⁰ VALENTINE.

90. RALPH VALENTINE⁹ MAGNUS (*KATE (KETURA)⁸ VALENTINE, SAUL HENRIQUES⁷, EMANUEL DE MOSES HENRIQUES⁶, MOSES HENRIQUES⁵, DAVID HENRIQUES⁴, MOSHE (MOSES) HENRIQUES³, DANIEL HENRIQUES², ? (THE SHEPHARDI) HENRIQUES¹*) was born 10 Sep 1880 in Poplar, London, England, and died 12 Oct 1946 in Ilford, Romford, Essex, England. He married DEBORAH (DEBBY) SAMUELS 1906 in London City, England. She was born 29 Sep 1879 in London City, England, and died 1945 in Ilford, Romford, Essex, England.

Children of RALPH MAGNUS and DEBORAH SAMUELS are:

- i. SAMUEL SYDNEY¹⁰ MAGNUS, b. 1908.
- ii. HYMAN C MAGNUS, b. 1910.
- iii. LOUIS REGINALD MAGNUS, b. 1911.
- iv. HORACE I MAGNUS, b. 1913.
- v. CATHERINE V MAGNUS.

91. REBECCA SARAH⁹ MAGNUS (*KATE (KETURA)⁸ VALENTINE, SAUL HENRIQUES⁷, EMANUEL DE MOSES HENRIQUES⁶, MOSES HENRIQUES⁵, DAVID HENRIQUES⁴, MOSHE (MOSES) HENRIQUES³, DANIEL HENRIQUES², ? (THE SHEPHARDI) HENRIQUES¹*) was born 08 Mar 1885 in Poplar, London, England, and died 30 Oct 1960 in East Ham, London, England. She married ABRAHAM FREEDMAN 1910 in Mile End Old Town, London, England.. He was born 20 Oct 1884 in Russia, and died 1953 in East Ham, London, England.

Children of REBECCA MAGNUS and ABRAHAM FREEDMAN are:

- i. ISRAEL¹⁰ FREEDMAN.
- ii. LOUIS V FREEDMAN.
- iii. HENRY J FREEDMAN.
- iv. CATHERINE M FREEDMAN.
- v. ROSALIND S FREEDMAN.
- vi. RALPH FREEDMAN.

92. SARAH⁹ MAGNUS (*KATE (KETURA)⁸ VALENTINE, SAUL HENRIQUES⁷, EMANUEL DE MOSES HENRIQUES⁶, MOSES HENRIQUES⁵, DAVID HENRIQUES⁴, MOSHE (MOSES) HENRIQUES³, DANIEL HENRIQUES², ? (THE SHEPHARDI) HENRIQUES¹*) was born 1888 in Poplar, London, England. She married EDWARD SOLOMON 1915 in Mile End Old Town, London, England. He was born Abt. 1887.

Children of SARAH MAGNUS and EDWARD SOLOMON are:

- i. HARRIS¹⁰ SOLOMON.
- ii. BARNEY B SOLOMON.
- iii. STANLEY DAVID SOLOMON.
- iv. ROSE SOLOMON.
- v. PHYLLIS SOLOMON.
- vi. FRANCES R SOLOMON.
- vii. RAPHAEL SOLOMON.

93. SAUL⁹ MAGNUS (*KATE (KETURA)⁸ VALENTINE, SAUL HENRIQUES⁷, EMANUEL DE MOSES HENRIQUES⁶, MOSES HENRIQUES⁵, DAVID HENRIQUES⁴, MOSHE (MOSES) HENRIQUES³, DANIEL HENRIQUES², ? (THE SHEPHARDI) HENRIQUES¹*) was born 23 Aug 1891 in Poplar, London, England, and died 1966 in Barking, London, England. He married SOPHIE FREEDMAN 1918 in West Ham, Essex, England. She was born 20 Nov 1892 in St Saviour, Southwark, Surrey, England, and died 1979 in Barking, London, England.

Child of SAUL MAGNUS and SOPHIE FREEDMAN is:

- i. JOHN¹⁰ MAGNUS.

94. WOOLFE (WALTER)⁹ MAGNUS (*KATE (KETURA)⁸ VALENTINE, SAUL HENRIQUES⁷, EMANUEL DE MOSES HENRIQUES⁶, MOSES HENRIQUES⁵, DAVID HENRIQUES⁴, MOSHE (MOSES) HENRIQUES³, DANIEL HENRIQUES², ? (THE SHEPHARDI) HENRIQUES¹*) was born 05 Mar 1894 in Poplar, London, England, and died 1960 in Wallingford, Berkshire, England. He married RACHEL REBECCA (RAY) PEARL 1923 in Mile End Old Town, London, England. She was born 21 Feb 1899 in Whitechapel, London, England, and died 1972 in Merton, Surrey, England.

Children of WOOLFE MAGNUS and RACHEL PEARL are:

- i. KATHLEEN VALENTINE¹⁰ MAGNUS.
- ii. BETTY R MAGNUS.

95. JOHN WESLEY (JACK)⁹ MAGNUS (*KATE (KETURA)⁸ VALENTINE, SAUL HENRIQUES⁷, EMANUEL DE MOSES HENRIQUES⁶, MOSES HENRIQUES⁵, DAVID HENRIQUES⁴, MOSHE (MOSES) HENRIQUES³, DANIEL HENRIQUES², ? (THE SHEPHARDI) HENRIQUES¹*) was born 17 Aug 1897 in Poplar, London, England, and died 1969 in Redbridge, London, England. He married ANNIE ISKY 1924 in Whitechapel, London, England. She was born 07 May 1904 in Whitechapel, London, England.

Children of JOHN MAGNUS and ANNIE ISKY are:

- i. KATE M¹⁰ MAGNUS.
- ii. STELLA MAGNUS.
- iii. SHEILA MAGNUS.

96. RUSSEL HYMAN⁹ MAGNUS (*KATE (KETURA)⁸ VALENTINE, SAUL HENRIQUES⁷, EMANUEL DE MOSES HENRIQUES⁶, MOSES HENRIQUES⁵, DAVID HENRIQUES⁴, MOSHE (MOSES) HENRIQUES³, DANIEL HENRIQUES², ? (THE SHEPHARDI) HENRIQUES¹*) was born 28 Mar 1899 in West Ham, Essex, England, and died 24 Apr 1987 in Auckland, New Zealand. He married ELLEN ELIZABETH SCOTT 26 Jul 1920 in West Ham, Essex, England. She was born 22 Jan 1899 in West Ham, Essex, England, and died 29 Jan 1980 in Auckland, New Zealand.

Children of RUSSEL MAGNUS and ELLEN SCOTT are:

- i. HELENA JOYCE¹⁰ MAGNUS.
- ii. MAURICE JOHN MAGNUS, b. 04 Oct 1922, North Street, Plaistow, West Ham; d. 26 Feb 2008, Takapuna, Auckland; m. JUNE OLWYN FAIRWEATHER, 06 Jun 1953, Mt Albert, Auckland; b. 09 Jun 1925; d. 09 Sep 2000, Tauranga.
- iii. SHIRLEY PAMELA MAGNUS.

97. JACOB⁹ NIEMAN (*AMELIA HENRIQUES⁸ VALENTINE, ABRAHAM HENRIQUES⁷, EMANUEL DE MOSES HENRIQUES⁶, MOSES HENRIQUES⁵, DAVID HENRIQUES⁴, MOSHE (MOSES) HENRIQUES³, DANIEL HENRIQUES², ? (THE SHEPHARDI) HENRIQUES¹*) was born 1860 in Brighton,Sussex. He married JANE REICHFELD 1884 in Westminster. She was born 1860 in Whitechapel,London.

Child of JACOB NIEMAN and JANE REICHFELD is:

- i. ADOLPH JOSEPH¹⁰ NEIMAN, b. 1891.

98. ELIZABETH⁹ NIEMAN (*AMELIA HENRIQUES⁸ VALENTINE, ABRAHAM HENRIQUES⁷, EMANUEL DE MOSES HENRIQUES⁶, MOSES HENRIQUES⁵, DAVID HENRIQUES⁴, MOSHE (MOSES) HENRIQUES³, DANIEL HENRIQUES², ? (THE SHEPHARDI) HENRIQUES¹*) was born 1864 in Brighton,Sussex. She married SAMUEL STEINBURG 1882 in West Derby,Lancashire. He was born 1863 in Liverpool,Lancashire.

Children of ELIZABETH NIEMAN and SAMUEL STEINBURG are:

- i. ESTHER¹⁰ STEINBURG, b. 1884, Liverpool,Lancashire.
- ii. ISABELLE STEINBURG, b. 1886, Liverpool,Lancashire.
- iii. BERNARD STEINBURG, b. 1888, Liverpool,Lancashire.
- iv. EMILAI STEINBURG, b. 1889, Liverpool,Lancashire.
- v. DAVID STEINBURG, b. 1891, Liverpool,Lancashire.
- vi. ADOLPHUS STEINBURG, b. 1892, Liverpool,Lancashire.
- vii. ADELINA STEINBURG, b. 1895, Liverpool,Lancashire.

99. JACOB SOLIS⁹ RITTERBAND (*BENVENIDA⁸ SOLIS, JACOB DA SILVA⁷, BENVENIDA DE ISAAC HENRIQUES⁶ VALENTINE, MOSES HENRIQUES⁵, DAVID HENRIQUES⁴, MOSHE (MOSES) HENRIQUES³, DANIEL HENRIQUES², ? (THE SHEPHARDI) HENRIQUES¹*) was born 26 Oct 1836 in New York, and died 11 Jan 1896 in New York. He married JOHANNA MICHAELIS.

Children of JACOB RITTERBAND and JOHANNA MICHAELIS are:

- i. STELLA BENVENIDA¹⁰ RITTERBAND, m. (1) FREDERICK WILLIAM HENNEKINS; m. (2) AUSTIN BRENNAN COSGROVE.
- ii. RITTERBAND, b. 09 Apr 1876, New York, New York.
- iii. FLORENCE RITTERBAND, b. 16 Sep 1876.
- iv. EDWARD RITTERBAND, b. 1877.
- v. DOROTHY LOUISA RITTERBAND, b. 25 Feb 1878; d. 27 Jan 1971, Tampa, Florida.
125. vi. GEORGE RITTERBAND, b. 26 Apr 1880.

100. LUCIA MANESS⁹ RITTERBAND (*BENVENIDA⁸ SOLIS, JACOB DA SILVA⁷, BENVENIDA DE ISAAC HENRIQUES⁶ VALENTINE, MOSES HENRIQUES⁵, DAVID HENRIQUES⁴, MOSHE (MOSES) HENRIQUES³, DANIEL HENRIQUES², ? (THE SHEPHARDI) HENRIQUES¹*) was born 27 Sep 1840 in New York, and died 10 Apr 1872. She married LEON DA SILVA SOLIS-COHEN, son of MYER COHEN and JUDITH SOLIS. He was born 16 Oct 1840 in Philadelphia, Pennsylvania, and died 19 Sep 1884.

Children of LUCIA RITTERBAND and LEON SOLIS-COHEN are:

- i. JESSIE MYRA¹⁰ SOLIS-COHEN.
- ii. GERTRUDE SOLIS-COHEN.
- iii. LEON MANESS SOLIS-COHEN.

101. SARAH (SALLY) MANESS⁹ RITTERBAND (*BENVENIDA⁸ SOLIS, JACOB DA SILVA⁷, BENVENIDA DE ISAAC HENRIQUES⁶ VALENTINE, MOSES HENRIQUES⁵, DAVID HENRIQUES⁴, MOSHE (MOSES) HENRIQUES³, DANIEL HENRIQUES², ? (THE SHEPHARDI) HENRIQUES¹*) was born 29 Mar 1846 in New York, NY, and died 06 Dec 1915 in New York. She married DAVID BRICKNER RITTERBAND 19 Oct 1870 in New York. He was born 14 Mar 1840 in Welbhausen, Bavaria, and died 30 Jan 1908 in New York.

Children of SARAH RITTERBAND and DAVID RITTERBAND are:

126. i. EDWIN SOLIS¹⁰ RITTERBAND, b. 09 Aug 1871, New York.
- ii. WALTER M. RITTERBAND, b. 28 Aug 1875, New York; d. 22 Jul 1930; m. PERLA S. ABRAHAMS.
127. iii. BENVENIDA SOLIS BRICKNER RITTERBAND, b. 26 May 1877, New York.

102. MOSES MANESS⁹ RITTERBAND (*BENVENIDA⁸ SOLIS, JACOB DA SILVA⁷, BENVENIDA DE ISAAC HENRIQUES⁶ VALENTINE, MOSES HENRIQUES⁵, DAVID HENRIQUES⁴, MOSHE (MOSES) HENRIQUES³, DANIEL HENRIQUES², ? (THE SHEPHARDI) HENRIQUES¹*) was born 28 Jan 1848 in New York. He married ESTHER AMANDA DE SOUZA 14 Feb 1869 in Chicago, Illinois. She was born 27 Sep 1852 in Falmouth, Trelawny, Jamaica, and died 12 Nov 1942 in Beverly Hills, California.

Children of MOSES RITTERBAND and ESTHER DE SOUZA are:

128. i. BENVENIDA SOLIS¹⁰ RITTERBAND, b. 25 Dec 1869; d. 26 Dec 1940, Beverly Hills, California.
- ii. EMILY ESTHER RITTERBAND, b. 24 Mar 1871, Chicago, Illinois; d. 12 Nov 1968, Los Angeles, California.
129. iii. LEON MANESS RITTERBAND, b. 07 Feb 1875, Ligonier, Noble, Indiana; d. 03 Dec 1943, Los Angeles, California.
- iv. DAISY SOLIS RITTERBAND, b. 24 Jun 1876, Ligonier, Noble, Indiana; d. 13 Jul 1951, Santa Monica, California.

103. DAVID SOLIS⁹ RITTERBAND (*BENVENIDA⁸ SOLIS, JACOB DA SILVA⁷, BENVENIDA DE ISAAC HENRIQUES⁶ VALENTINE, MOSES HENRIQUES⁵, DAVID HENRIQUES⁴, MOSHE (MOSES) HENRIQUES³, DANIEL HENRIQUES², ? (THE SHEPHARDI) HENRIQUES¹*) was born 18 Sep 1850 in New York, and died 25 Dec 1926 in New York. He married ANNIE BROWN 01 Nov 1881 in New York. She was born 1861.

Children of DAVID RITTERBAND and ANNIE BROWN are:

- i. VIOLA FONSECA DA SILVA¹⁰ RITTERBAND, b. 22 Feb 1883; m. (1) MAURICE L. POWERS; m. (2) MAX ASH.
- ii. JULIAN HART SOLIS RITTERBAND, b. 01 Jun 1885; d. 01 Feb 1950.
- iii. GLADYS DA SILVA SOLIS RITTERBAND, b. 24 Dec 1890; m. SANFORD (GOLDBERG) GARDNER, 19 Apr 1917, New York; b. 1883.

104. LEON DA SILVA⁹ SOLIS-COHEN (*JUDITH SIMHA⁸ SOLIS, JACOB DA SILVA⁷, BENVENIDA DE ISAAC HENRIQUES⁶ VALENTINE, MOSES HENRIQUES⁵, DAVID HENRIQUES⁴, MOSHE (MOSES) HENRIQUES³, DANIEL HENRIQUES², ? (THE SHEPHARDI) HENRIQUES¹*) was born 16 Oct 1840 in Philadelphia, Pennsylvania, and died 19 Sep 1884. He married LUCIA MANESS RITTERBAND, daughter of LEON RITTERBAND and BENVENIDA SOLIS. She was born 27 Sep 1840 in New York, and died 10 Apr 1872.

Children are listed above under (100) Lucia Maness Ritterband.

105. LILIAN MAE⁹ VALENTINE (*SAMUEL⁸, SAMUEL⁷, DAVID HENRIQUES⁶, MOSES HENRIQUES⁵, DAVID HENRIQUES⁴, MOSHE (MOSES) HENRIQUES³, DANIEL HENRIQUES², ? (THE SHEPHARDI) HENRIQUES¹*) was born 29 Mar 1873 in Brooklyn Ward 4, Kings Cty, New York, and died 11 Aug 1969 in Charlottesville, Albemarle, Virginia, USA. She married STURGES FRANCIS MEEK 18 Dec 1895 in Lilian's home, Brooklyn, Kings Co., NY, son of RICHARD MEEK and PHOEBE DUNN. He was born 26 Jun 1874 in New York, USA, and died 16 Jun 1934 in New York, USA.

Children of LILIAN VALENTINE and STURGES MEEK are:

130. i. ELLA GERTRUDE¹⁰ MEEK, b. 22 Aug 1908, Brooklyn, New York, New York, USA; d. 29 Sep 1974, Riverhead, Suffolk, New York, United States of America.
- ii. GRACE E MEEK, b. 31 Mar 1897, Brooklyn, New York, New York, USA.
- iii. LILLIAN M MEEK, b. 05 Feb 1900, Brooklyn, New York, New York, USA.

106. SOPHIA REBECCA⁹ BECKET (*HANNAH HENRIQUES⁸ VALENTINE, SAUL HENRIQUES⁷, ELIAS HENRIQUES⁶, MOSES HENRIQUES⁵, DAVID HENRIQUES⁴, MOSHE (MOSES) HENRIQUES³, DANIEL HENRIQUES², ? (THE SHEPHARDI) HENRIQUES¹*) was born 1874, and died 1946. She married LOUIS AUGUSTE COSSART.

Child of SOPHIA BECKET and LOUIS COSSART is:

131. i. ELIZABETH MARY¹⁰ COSSART, b. 09 Oct 1916.

107. JOSEPH GARDNER⁹ VALENTINE (*JOSEPH⁸, JOSEPH MOSES⁷, DAVID (DE JEHOSHUA) HENRIQUES⁶, JEHOSHUA HENRIQUES⁵, DAVID HENRIQUES⁴, MOSHE (MOSES) HENRIQUES³, DANIEL HENRIQUES², ? (THE SHEPHARDI) HENRIQUES¹*) was born 18 Feb 1877 in Dalston, Hackney, Middlesex, and died Aft. 1912 in USA. He married ANNE ELIZABETH PEARSON 24 Nov 1900 in St Matthews, Islington, Middlesex. She was born 1877 in Dalston, Middlesex.

Child of JOSEPH VALENTINE and ANNE PEARSON is:

132. i. JOHN CHARLES¹⁰ VALENTINE, b. 27 Sep 1905, Newington North, Southwark, London; d. 1983.

Generation No. 10

108. NORMA MARGARET LOUISA¹⁰ HARRIS (*MARGARET MIRIAM (MAY)⁹ VALENTINE, COLEMAN (COLONIMUS) HENRIQUES⁸, ISAAC HENRIQUES⁷, EMANUEL DE MOSES HENRIQUES⁶, MOSES HENRIQUES⁵, DAVID HENRIQUES⁴, MOSHE (MOSES) HENRIQUES³, DANIEL HENRIQUES², ? (THE SHEPHARDI) HENRIQUES¹*) was born 12 Jan 1930 in Alexandra Nursing Home, 28 Hanson Street, Newtown, Wellington, and died 11 Dec 2011 in St Andrews Hospital, Glendowie, Auckland. She married EDWIN (EDDIE) LISTER HANDRICKS 31 Oct 1953 in 2:00pm St Davids Church, Naenae, Wellington, son of NORMAN HANDRICKS and RUBY STAGGARD. He was born 05 Mar 1926 in Lister Hospital, Riverside Road, Gisborne, and died 01 May 2011 in Middlemore Hospital, Auckland.

Children of NORMA HARRIS and EDWIN HANDRICKS are:

133. i. IAN LISTER¹¹ HANDRICKS, b. 06 Jul 1955, At Home, 9 Farringdon St, Glen Innes, Auckland.
134. ii. LYNETTE MARGARET HANDRICKS, b. 02 Jul 1957, At Home, 9 Farringdon St, Glen Innes, Auckland.
135. iii. GLENN PETER HANDRICKS, b. 03 Mar 1966, Middlemore Hospital, Auckland.

109. FREDERICK CHARLES¹⁰ HARRIS (*MARGARET MIRIAM (MAY)⁹ VALENTINE, COLEMAN (COLONIMUS) HENRIQUES⁸, ISAAC HENRIQUES⁷, EMANUEL DE MOSES HENRIQUES⁶, MOSES HENRIQUES⁵, DAVID HENRIQUES⁴, MOSHE (MOSES) HENRIQUES³, DANIEL HENRIQUES², ? (THE SHEPHARDI) HENRIQUES¹*) was born 07 Jul 1922 in Mile End Rd, Stepney, London, and died 05 Jun 1999 in 53 Fairs Rd., Palmerston North. He married ALDRED HELEN BROOKS 1947 in Palmerston North, daughter of HENRY BROOKS and EMILY SOWTER. She was born 15 Jul 1918 in Palmerston North, and died 09 Dec 1997 in Monrad Rest Home, 124 Monrad St, Palmerston North.

Child of FREDERICK HARRIS and ALDRED BROOKS is:

- i. VICKY MICHELLE¹¹ HARRIS, b. 10 Oct 1958, Palmerston North; m. DAVID SHACKLETON.

110. WILLIAM COLEMAN¹⁰ VALENTINE (*ARTHUR ISAAC⁹, COLEMAN (COLONIMUS) HENRIQUES⁸, ISAAC HENRIQUES⁷, EMANUEL DE MOSES HENRIQUES⁶, MOSES HENRIQUES⁵, DAVID HENRIQUES⁴, MOSHE (MOSES) HENRIQUES³, DANIEL HENRIQUES², ? (THE SHEPHARDI) HENRIQUES¹*) was born 26 May 1918 in Basford, Notts, and died 1976 in Waltham Forest, London. He married LILLIAN ALICE BARNETT 1944 in St Peter St Pauls, Chingford, daughter of THOMAS BARNETT and LILY CURSON. She was born 10 Apr 1926 in Hackney, Middx, London.

Children of WILLIAM VALENTINE and LILLIAN BARNETT are:

136. i. DAVID ARTHUR¹¹ VALENTINE, b. 31 Dec 1948, St Andrews Hospital, Bow.
137. ii. JOHN ARTHUR VALENTINE, b. 18 Jul 1951, Chingford.

111. ROBERT (BOB) JOSEPH¹⁰ VALENTINE (*ARTHUR ISAAC⁹, COLEMAN (COLONIMUS) HENRIQUES⁸, ISAAC HENRIQUES⁷, EMANUEL DE MOSES HENRIQUES⁶, MOSES HENRIQUES⁵, DAVID HENRIQUES⁴, MOSHE (MOSES) HENRIQUES³, DANIEL HENRIQUES², ? (THE SHEPHARDI) HENRIQUES¹*) was born 23 Mar 1932 in Epping. He married FRANCES L MCDUFF 1955 in Essex.

Children of ROBERT VALENTINE and FRANCES MCDUFF are:

- i. KEITH R¹¹ VALENTINE, b. 1956, Edmonton.
138. ii. RUSSELL J VALENTINE, b. 1964, Basildon.

112. ALFRED WILLIAM¹⁰ FRANCIS (*JULIE LOUISA⁹ VALENTINE, COLEMAN (COLONIMUS) HENRIQUES⁸, ISAAC HENRIQUES⁷, EMANUEL DE MOSES HENRIQUES⁶, MOSES HENRIQUES⁵, DAVID HENRIQUES⁴, MOSHE (MOSES) HENRIQUES³, DANIEL HENRIQUES², ? (THE SHEPHARDI) HENRIQUES¹*) was born 22 Mar 1916 in West Ham, Essex, London, and died 01 Mar 1997. He married GWENDOLINE L H EVANS 1946 in Ilford, Essex. She was born 09 Oct 1916, and died 06 May 2004.

Children of ALFRED FRANCIS and GWENDOLINE EVANS are:

139. i. CHRISTOPHER¹¹ FRANCIS, b. 1949, West Ham, Essex, London.
140. ii. WENDY S FRANCIS, b. 1955, West Ham, Essex, London.

113. LOUISE JULIE¹⁰ FRANCIS (*JULIE LOUISA⁹ VALENTINE, COLEMAN (COLONIMUS) HENRIQUES⁸, ISAAC HENRIQUES⁷, EMANUEL DE MOSES HENRIQUES⁶, MOSES HENRIQUES⁵, DAVID HENRIQUES⁴, MOSHE (MOSES) HENRIQUES³, DANIEL HENRIQUES², ? (THE SHEPHARDI) HENRIQUES¹*) was born 13 Jan 1912 in West Ham, London, and died 29 Nov 2009. She married ARTHUR STANLEY DOVE 09 Oct 1937 in St Johns Church, Seven Kings, Ilford, Essex, son of HAROLD DOVE and JANE ALLEN. He was born 20 Jun 1904 in Plaistow, West Ham, Essex, and died 06 Oct 2000.

Children of LOUISE FRANCIS and ARTHUR DOVE are:

141. i. ALAN L¹¹ DOVE, b. 11 Nov 1943, Ilford, Essex.
142. ii. LESLIE DOVE.

114. JACK HERBERT (JACKIE)¹⁰ WILLIAMS (*JANE DAVIS⁹ VALENTINE, COLEMAN (COLONIMUS) HENRIQUES⁸, ISAAC HENRIQUES⁷, EMANUEL DE MOSES HENRIQUES⁶, MOSES HENRIQUES⁵, DAVID HENRIQUES⁴, MOSHE (MOSES) HENRIQUES³, DANIEL HENRIQUES², ? (THE SHEPHARDI) HENRIQUES¹*) was born 1924 in Mile End London England. He married JUNE ?.

Child of JACK WILLIAMS and JUNE ? is:

- i. MARK¹¹ WILLIAMS.

115. GILBERT DOUGLAS¹⁰ WILLIAMS (*JANE DAVIS⁹ VALENTINE, COLEMAN (COLONIMUS) HENRIQUES⁸, ISAAC HENRIQUES⁷, EMANUEL DE MOSES HENRIQUES⁶, MOSES HENRIQUES⁵, DAVID HENRIQUES⁴, MOSHE (MOSES) HENRIQUES³, DANIEL HENRIQUES², ? (THE SHEPHARDI) HENRIQUES¹*) was born 1919 in Holborn, London. He married NELLIE ?.

Children of GILBERT WILLIAMS and NELLIE ? are:

143. i. MICHAEL¹¹ WILLIAMS.
- ii. PETER WILLIAMS.
- iii. PATRICK WILLIAMS.

116. DORIS NELLIE¹⁰ WILLIAMS (*JANE DAVIS⁹ VALENTINE, COLEMAN (COLONIMUS) HENRIQUES⁸, ISAAC HENRIQUES⁷, EMANUEL DE MOSES HENRIQUES⁶, MOSES HENRIQUES⁵, DAVID HENRIQUES⁴, MOSHE (MOSES) HENRIQUES³, DANIEL HENRIQUES², ? (THE SHEPHARDI) HENRIQUES¹*) was born 1922 in Mile End London England. She married (1) FRANK W A BENNETT 1942 in Brentford, Middx. She married (2) THEODORE ANDREW STANLEY 1953 in Chelmsford, Essex. He was born Abt. 1927, and died 08 Jul 2010 in at home.

Child of DORIS WILLIAMS and FRANK BENNETT is:

144. i. KEITH F¹¹ BENNETT, b. 1943, Chelmsford, Essex.

117. GEORGE COLEMAN¹⁰ VALENTINE (*ALFRED (ABRAHAM JOHN)⁹, COLEMAN (COLONIMUS) HENRIQUES⁸, ISAAC HENRIQUES⁷, EMANUEL DE MOSES HENRIQUES⁶, MOSES HENRIQUES⁵, DAVID HENRIQUES⁴, MOSHE (MOSES) HENRIQUES³, DANIEL HENRIQUES², ? (THE SHEPHARDI) HENRIQUES¹*) was born 22 Dec 1922 in West Ham, London, and died Jan 2005 in Chiltern, Buckinghamshire. He married SYLVIA ASTHORE WALKER 1947 in Uxbridge, Middlesex. She was born 21 May 1923, and died Feb 2004 in Chiltern, Buckinghamshire.

Children of GEORGE VALENTINE and SYLVIA WALKER are:

- i. PETER N¹¹ VALENTINE, b. 1949, Ilford, Essex.
- ii. JANE E VALENTINE, b. 1951, Ilford, Essex.

118. PETER BENJAMIN¹⁰ VALENTINE (*MICHAEL (ISHMAIL) DAVIS⁹, BENJAMIN HENRIQUES⁸, ISAAC HENRIQUES⁷, EMANUEL DE MOSES HENRIQUES⁶, MOSES HENRIQUES⁵, DAVID HENRIQUES⁴, MOSHE (MOSES) HENRIQUES³, DANIEL HENRIQUES², ? (THE SHEPHARDI) HENRIQUES¹*)

Child of PETER BENJAMIN VALENTINE is:

- i. JOHNATHAN SETH¹¹ VALENTINE.

119. ALFRED¹⁰ TOURNOFF (*CATHERINE⁹ VALENTINE, ABRAHAM HENRIQUES⁸, ISAAC HENRIQUES⁷, EMANUEL DE MOSES HENRIQUES⁶, MOSES HENRIQUES⁵, DAVID HENRIQUES⁴, MOSHE (MOSES) HENRIQUES³, DANIEL HENRIQUES², ? (THE SHEPHARDI) HENRIQUES¹*) was born Abt. 1894 in Whitechapel Middlesex London England. He married ELIZABETH TOFF 1925 in London, daughter of JOSEPH TOFF and REBECCA VALENTINE. She was born Abt. 1899 in Mile End London England.

Children of ALFRED TOURNOFF and ELIZABETH TOFF are:

- i. ERIC¹¹ TOURNOFF.
- ii. DUDLEY TOURNOFF.

120. JACOB (JACK)¹⁰ TOFF (*REBECCA⁹ VALENTINE, ABRAHAM HENRIQUES⁸, ISAAC HENRIQUES⁷, EMANUEL DE MOSES HENRIQUES⁶, MOSES HENRIQUES⁵, DAVID HENRIQUES⁴, MOSHE (MOSES) HENRIQUES³, DANIEL HENRIQUES², ? (THE SHEPHARDI) HENRIQUES¹*) was born Abt. 1898 in Mile End, London, England. He married AMELIA ABRAHAMS 1924 in Mile End, London, England, daughter of JACOB ABRAHAMS and REBECCA BARNETT. She was born 1899 in London, England.

Children of JACOB TOFF and AMELIA ABRAHAMS are:

- i. BERYL R¹¹ TOFF, b. 1928, Stepney, London; m. GERALD P MASON, 1953, Ilford, Essex.
145. ii. GERALD J TOFF, b. 1932, Woolich, London.
- iii. ALAN J TOFF, b. 1934, Romford, Essex.

121. ELIZABETH¹⁰ TOFF (*REBECCA⁹ VALENTINE, ABRAHAM HENRIQUES⁸, ISAAC HENRIQUES⁷, EMANUEL DE MOSES HENRIQUES⁶, MOSES HENRIQUES⁵, DAVID HENRIQUES⁴, MOSHE (MOSES) HENRIQUES³, DANIEL HENRIQUES², ? (THE SHEPHARDI) HENRIQUES¹*) was born Abt. 1899 in Mile End London England. She married ALFRED TOURNOFF 1925 in London, son of HYMAN TOURNOFF and CATHERINE VALENTINE. He was born Abt. 1894 in Whitechapel Middlesex London England.

Children are listed above under (119) Alfred Tournoff.

122. ABRAHAM (ALFRED)¹⁰ TOFF (*REBECCA⁹ VALENTINE, ABRAHAM HENRIQUES⁸, ISAAC HENRIQUES⁷, EMANUEL DE MOSES HENRIQUES⁶, MOSES HENRIQUES⁵, DAVID HENRIQUES⁴, MOSHE (MOSES) HENRIQUES³, DANIEL HENRIQUES², ? (THE SHEPHARDI) HENRIQUES¹*) was born 31 Dec 1899 in Stepney, London, England. He married CAROLINE ABRAHAMS 1925 in Mile End, daughter of JACOB ABRAHAMS and REBECCA BARNETT. She was born Abt. 1901 in London, England.

Children of ABRAHAM TOFF and CAROLINE ABRAHAMS are:

146. i. JOSEPH DENNIS¹¹ TOFF, b. 31 Dec 1926, Hackney, London.
147. ii. SHEILA TOFF, b. 1931, Romford, Essex.

123. KATE (KITTY)¹⁰ TOFF (*ANNIE⁹ VALENTINE, ABRAHAM HENRIQUES⁸, ISAAC HENRIQUES⁷, EMANUEL DE MOSES HENRIQUES⁶, MOSES HENRIQUES⁵, DAVID HENRIQUES⁴, MOSHE (MOSES) HENRIQUES³, DANIEL HENRIQUES², ? (THE SHEPHARDI) HENRIQUES¹*) was born Abt. 1915. She married RUBIN COHEN COLLYER.

Child of KATE TOFF and RUBIN COLLYER is:

148. i. BARBARA¹¹ COLLYER.

124. HENRY (HARRY)¹⁰ BAUM (*HANNAH⁹ LEVY, SARAH CONSTANCE ENRIQUES⁸ VALENTINE, SAUL HENRIQUES⁷, EMANUEL DE MOSES HENRIQUES⁶, MOSES HENRIQUES⁵, DAVID HENRIQUES⁴, MOSHE (MOSES) HENRIQUES³, DANIEL HENRIQUES², ? (THE SHEPHARDI) HENRIQUES¹*) was born 20 Apr 1912 in Hackney, London, England, and died 14 Jul 1942 in as a Prisoner of War of malaria in Changi prison, Singapore. He married THERESA (TERRY) DAVIS Dec 1936 in Edmonton, Middlesex, England, daughter of CHARLES DAVIS and ROSETTA KONYN. She was born 22 Mar 1915 in London, England, and died 1995 in London, England.

Child of HENRY BAUM and THERESA DAVIS is:

149. i. ROSANNE¹¹ BAUM, b. 12 Sep 1937, 8 Marywood Square, Glasgow, Scotland.

125. GEORGE¹⁰ RITTERBAND (*JACOB SOLIS⁹, BENVENIDA⁸ SOLIS, JACOB DA SILVA⁷, BENVENIDA DE ISAAC HENRIQUES⁶ VALENTINE, MOSES HENRIQUES⁵, DAVID HENRIQUES⁴, MOSHE (MOSES) HENRIQUES³, DANIEL HENRIQUES², ? (THE SHEPHARDI) HENRIQUES¹*) was born 26 Apr 1880. He married FLORENCE JESSILSON 26 Aug 1908. She was born 1880.

Child of GEORGE RITTERBAND and FLORENCE JESSILSON is:

i. PHILIP¹¹ RITTERBAND.

126. EDWIN SOLIS¹⁰ RITTERBAND (*SARAH (SALLY) MANESS⁹, BENVENIDA⁸ SOLIS, JACOB DA SILVA⁷, BENVENIDA DE ISAAC HENRIQUES⁶ VALENTINE, MOSES HENRIQUES⁵, DAVID HENRIQUES⁴, MOSHE (MOSES) HENRIQUES³, DANIEL HENRIQUES², ? (THE SHEPHARDI) HENRIQUES¹*) was born 09 Aug 1871 in New York. He married MYRA DE CORDOVA.

Children of EDWIN RITTERBAND and MYRA DE CORDOVA are:

- i. HELEN DE CORDOVA¹¹ RITTERBAND, m. NEWTON KENT.
- ii. MARGARET RITTERBAND, m. ROBERT S. ZUCKERMAN.
- iii. KATHRYN RITTERBAND, m. EDWIN A. WEILLER.

127. BENVENIDA SOLIS BRICKNER¹⁰ RITTERBAND (*SARAH (SALLY) MANESS⁹, BENVENIDA⁸ SOLIS, JACOB DA SILVA⁷, BENVENIDA DE ISAAC HENRIQUES⁶ VALENTINE, MOSES HENRIQUES⁵, DAVID HENRIQUES⁴, MOSHE (MOSES) HENRIQUES³, DANIEL HENRIQUES², ? (THE SHEPHARDI) HENRIQUES¹*) was born 26 May 1877 in New York. She married GOODMAN RICHARD DAVIS 17 Oct 1900. He was born 27 Jun 1876.

Children of BENVENIDA RITTERBAND and GOODMAN DAVIS are:

150. i. WALTER ALAN¹¹ DAVIS.
- ii. GOODMAN RICHARD DAVIS.

128. BENVENIDA SOLIS¹⁰ RITTERBAND (*MOSES MANESS⁹, BENVENIDA⁸ SOLIS, JACOB DA SILVA⁷, BENVENIDA DE ISAAC HENRIQUES⁶ VALENTINE, MOSES HENRIQUES⁵, DAVID HENRIQUES⁴, MOSHE (MOSES) HENRIQUES³, DANIEL HENRIQUES², ? (THE SHEPHARDI) HENRIQUES¹*) was born 25 Dec 1869, and died 26 Dec 1940 in Beverly Hills, California. She married EMIL FIRTH 24 Oct 1894 in Chicago, Illinois. He was born 25 Jan 1857 in Bohemia, and died 23 Aug 1922 in Los Angeles, California.

Child of BENVENIDA RITTERBAND and EMIL FIRTH is:

151. i. MILDRED¹¹ FIRTH, b. 13 Mar 1896, Chicago, Illinois; d. 17 Nov 1978, Beverly Hills, California.

129. LEON MANESS¹⁰ RITTERBAND (*MOSES MANESS⁹, BENVENIDA⁸ SOLIS, JACOB DA SILVA⁷, BENVENIDA DE ISAAC HENRIQUES⁶ VALENTINE, MOSES HENRIQUES⁵, DAVID HENRIQUES⁴, MOSHE (MOSES) HENRIQUES³, DANIEL HENRIQUES², ? (THE SHEPHARDI) HENRIQUES¹*) was born 07 Feb 1875 in Ligonier, Noble, Indiana, and died 03 Dec 1943 in Los Angeles, California. He married LAURA ("LOLLIE") BERMAN 02 Sep 1903 in Chicago, Illinois. She was born 11 Jan 1877 in Decatur, Michigan, and died 16 Dec 1947 in Los Angeles, California.

Children of LEON RITTERBAND and LAURA BERMAN are:

- i. RICHARD LEON¹¹ RITTERBAND, m. FRANCES EVELYN CADWELL; b. 09 Jan 1913, Santa Maria, California; d. 30 Aug 1989.
- ii. MARION FRANCES RITTERBAND, b. 19 May 1905, Chicago, Illinois; d. 18 Aug 1920, Los Angeles, California.
152. iii. ROBERT MANESS RITTERBAND, b. 16 Jun 1909, Chicago, Illinois; d. 21 May 2000, Los Angeles, California.
- iv. EDWARD PHILIP ("BILL") RITTERBAND, b. 16 Jun 1909; d. Sep 1986, San Mateo, California; m. ENID CATHERINE ("JOAN") GREENFIELD.

130. ELLA GERTRUDE¹⁰ MEEK (*LILIAN MAE⁹ VALENTINE, SAMUEL⁸, SAMUEL⁷, DAVID HENRIQUES⁶, MOSES HENRIQUES⁵, DAVID HENRIQUES⁴, MOSHE (MOSES) HENRIQUES³, DANIEL HENRIQUES², ? (THE SHEPHARDI) HENRIQUES¹*) was born 22 Aug 1908 in Brooklyn, New York, New York, USA, and died 29 Sep 1974 in Riverhead, Suffolk, New York, United States of America. She married FLOYD WILSON HOAGLIN 23 Aug 1941 in Provincetown, Massachusetts, USA, son of AUSTIN HOAGLIN and GOLDIE EWING. He was born 28 Nov 1918 in Nebo homestead, IL, and died 09 Mar 2002 in Chesterfield, MO.

Child of ELLA MEEK and FLOYD HOAGLIN is:

- i. JOYCE¹¹ HOAGLIN, m. ? HORYCZUN.

131. ELIZABETH MARY¹⁰ COSSART (*SOPHIA REBECCA⁹ BECKET, HANNAH HENRIQUES⁸ VALENTINE, SAUL HENRIQUES⁷, ELIAS HENRIQUES⁶, MOSES HENRIQUES⁵, DAVID HENRIQUES⁴, MOSHE (MOSES) HENRIQUES³, DANIEL HENRIQUES², ? (THE SHEPHARDI) HENRIQUES¹*) was born 09 Oct 1916. She married RODNEY PHILIP ARTHUR ADAIR. He was born 13 Oct 1921.

Child of ELIZABETH COSSART and RODNEY ADAIR is:

- i. MICHAEL RODNEY¹¹ ADAIR, b. 24 Aug 1947.

132. JOHN CHARLES¹⁰ VALENTINE (*JOSEPH GARDNER⁹, JOSEPH⁸, JOSEPH MOSES⁷, DAVID (DE JEHOSSUA) HENRIQUES⁶, JEHOSSUA HENRIQUES⁵, DAVID HENRIQUES⁴, MOSHE (MOSES) HENRIQUES³, DANIEL HENRIQUES², ? (THE SHEPHARDI) HENRIQUES¹*) was born 27 Sep 1905 in Newington North, Southwark, London, and died 1983. He married NELLIE MAY POWELL. She was born 27 May 1906 in North Leyton, West Ham.

Child of JOHN VALENTINE and NELLIE POWELL is:

- i. DAVID CHARLES¹¹ VALENTINE, b. 20 May 1945; m. DENISE ANITA DUNKLEY, 23 Mar 1968, Manford Way Free Church, Ilford, Essex; b. 05 Nov 1945.

Generation No. 11

133. IAN LISTER¹¹ HANDRICKS (*NORMA MARGARET LOUISA¹⁰ HARRIS, MARGARET MIRIAM (MAY)⁹ VALENTINE, COLEMAN (COLONIMUS) HENRIQUES⁸, ISAAC HENRIQUES⁷, EMANUEL DE MOSES HENRIQUES⁶, MOSES HENRIQUES⁵, DAVID HENRIQUES⁴, MOSHE (MOSES) HENRIQUES³, DANIEL HENRIQUES², ? (THE SHEPHARDI) HENRIQUES¹*) was born 06 Jul 1955 in At Home, 9 Farrington St, Glen Innes, Auckland. He married JOCELYN RUTH BROWN 11 Feb 1978 in Holy Trinity Anglican Church, Dargaville, daughter of OWEN BROWN and ROMA SIMONS. She was born 16 Dec 1954 in Te Kopuru.

Children of IAN HANDRICKS and JOCELYN BROWN are:

- i. DANIEL LOGAN¹² HANDRICKS, b. 20 May 1981, National Women's Hospital, Auckland; d. 08 May 2017, 40 Grant Ave, Hope Island, Gold Coast, Queensland, Australia.
- ii. HELEN RUBY HANDRICKS, b. 31 Oct 1983, John Radcliffe Hospital, Oxford, England; m. RICHARD GLEW, 03 Jan 2020, Australia.
- iii. ÉLOÏSE ADÈLE HANDRICKS, b. 11 Oct 1985, John Radcliffe Hospital, Oxford, England; m. ANTON GILBERT, 03 Oct 2020, Brisbane, Australia.

134. LYNETTE MARGARET¹¹ HANDRICKS (*NORMA MARGARET LOUISA*¹⁰ HARRIS, *MARGARET MIRIAM (MAY)*⁹ VALENTINE, *COLEMAN (COLONIMUS) HENRIQUES*⁸, *ISAAC HENRIQUES*⁷, *EMANUEL DE MOSES HENRIQUES*⁶, *MOSES HENRIQUES*⁵, *DAVID HENRIQUES*⁴, *MOSHE (MOSES) HENRIQUES*³, *DANIEL HENRIQUES*², ? (*THE SHEPHARDI HENRIQUES*¹) was born 02 Jul 1957 in At Home, 9 Farringdon St, Glen Innes, Auckland. She married SIANG HUAT OOI 25 Mar 1978 in Auckland, son of HOI OOI and SAW PHAN. He was born 30 Nov 1952 in Malaysia.

Children of LYNETTE HANDRICKS and SIANG OOI are:

- i. LISA MARGARET¹² OOI, b. 20 Oct 1981.
153. ii. FIONA MAY OOI, b. 22 Mar 1984, Auckland.
- iii. ROBYN JANE OOI, b. 31 Dec 1987.

135. GLENN PETER¹¹ HANDRICKS (*NORMA MARGARET LOUISA*¹⁰ HARRIS, *MARGARET MIRIAM (MAY)*⁹ VALENTINE, *COLEMAN (COLONIMUS) HENRIQUES*⁸, *ISAAC HENRIQUES*⁷, *EMANUEL DE MOSES HENRIQUES*⁶, *MOSES HENRIQUES*⁵, *DAVID HENRIQUES*⁴, *MOSHE (MOSES) HENRIQUES*³, *DANIEL HENRIQUES*², ? (*THE SHEPHARDI HENRIQUES*¹) was born 03 Mar 1966 in Middlemore Hospital, Auckland. He married (1) JUNE ELIZABETH DAVISON 12 Sep 1987 in Auckland, daughter of ROY BRINK and MARJORIE PAPE. She was born 06 Mar 1966 in Australia. He married (2) FAY LUCINDA WILKINSON 13 Jul 2019 in Sandy Creek, Queensland, daughter of ROBERT WILKINSON and LEILA SANDERS. She was born 04 Mar 1965 in Horsham, Victoria.

Children of GLENN HANDRICKS and JUNE DAVISON are:

- i. KIMBERLEY MARIE¹² HANDRICKS, b. 15 Jul 1995, Auckland.
- ii. KELLIE JUNE HANDRICKS, b. 15 Mar 1998, Auckland.

136. DAVID ARTHUR¹¹ VALENTINE (*WILLIAM COLEMAN*¹⁰, *ARTHUR ISAAC*⁹, *COLEMAN (COLONIMUS) HENRIQUES*⁸, *ISAAC HENRIQUES*⁷, *EMANUEL DE MOSES HENRIQUES*⁶, *MOSES HENRIQUES*⁵, *DAVID HENRIQUES*⁴, *MOSHE (MOSES) HENRIQUES*³, *DANIEL HENRIQUES*², ? (*THE SHEPHARDI HENRIQUES*¹) was born 31 Dec 1948 in St Andrews Hospital, Bow. He married SANDRA CHRISTINE ARCHARD 12 Apr 1969 in Holy Trinity, South Woodford, daughter of BERNARD ARCHARD and IRENE LUCAS. She was born 20 Feb 1951 in Wanstead Hospital.

Child of DAVID VALENTINE and SANDRA ARCHARD is:

154. i. JASON MATTHEW¹² VALENTINE, b. 30 Aug 1969, Barking, Essex.

137. JOHN ARTHUR¹¹ VALENTINE (*WILLIAM COLEMAN*¹⁰, *ARTHUR ISAAC*⁹, *COLEMAN (COLONIMUS) HENRIQUES*⁸, *ISAAC HENRIQUES*⁷, *EMANUEL DE MOSES HENRIQUES*⁶, *MOSES HENRIQUES*⁵, *DAVID HENRIQUES*⁴, *MOSHE (MOSES) HENRIQUES*³, *DANIEL HENRIQUES*², ? (*THE SHEPHARDI HENRIQUES*¹) was born 18 Jul 1951 in Chingford. He married (1) BARBARA ?. He married (2) GILLIAN CAMPBELL 14 Feb 1987 in Waltham Forest, London. He married (3) THERESA SULLIVAN 19 Jul 2010 in St Lucia.

Child of JOHN VALENTINE and GILLIAN CAMPBELL is:

- i. JAY WILLIAM COLEMAN¹² VALENTINE, b. 14 Feb 1989, Waltham Forest, London.

138. RUSSELL J¹¹ VALENTINE (*ROBERT (BOB) JOSEPH*¹⁰, *ARTHUR ISAAC*⁹, *COLEMAN (COLONIMUS) HENRIQUES*⁸, *ISAAC HENRIQUES*⁷, *EMANUEL DE MOSES HENRIQUES*⁶, *MOSES HENRIQUES*⁵, *DAVID HENRIQUES*⁴, *MOSHE (MOSES) HENRIQUES*³, *DANIEL HENRIQUES*², ? (*THE SHEPHARDI HENRIQUES*¹) was born 1964 in Basildon. He married KELLY M SCOTT 1995 in Southend on Sea, daughter of GORDON SCOTT and JUNE FULLER. She was born 1963 in Basildon, Essex.

Children of RUSSELL VALENTINE and KELLY SCOTT are:

- i. RUBY ELLEANOR¹² VALENTINE, b. 25 Mar 1992, Basildon, Essex.
- ii. MERRIDY JOSEPHINE VALENTINE, b. 19 Feb 1996, Basildon, Essex.

139. CHRISTOPHER¹¹ FRANCIS (*ALFRED WILLIAM*¹⁰, *JULIE LOUISA*⁹ VALENTINE, *COLEMAN (COLONIMUS) HENRIQUES*⁸, *ISAAC HENRIQUES*⁷, *EMANUEL DE MOSES HENRIQUES*⁶, *MOSES HENRIQUES*⁵, *DAVID HENRIQUES*⁴, *MOSHE (MOSES) HENRIQUES*³, *DANIEL HENRIQUES*², ? (*THE SHEPHARDI HENRIQUES*¹) was born 1949 in West Ham, Essex, London. He married NELGA HELEN H BOGISCH.

Child of CHRISTOPHER FRANCIS and NELGA BOGISCH is:

- i. KARL¹² CHRISTOPHER.

140. WENDY S¹¹ FRANCIS (*ALFRED WILLIAM¹⁰, JULIE LOUISA⁹ VALENTINE, COLEMAN (COLONIMUS) HENRIQUES⁸, ISAAC HENRIQUES⁷, EMANUEL DE MOSES HENRIQUES⁶, MOSES HENRIQUES⁵, DAVID HENRIQUES⁴, MOSHE (MOSES) HENRIQUES³, DANIEL HENRIQUES², ? (THE SHEPHARDI) HENRIQUES¹*) was born 1955 in West Ham, Essex, London. She married HUGH LLOYD.

Child of WENDY FRANCIS and HUGH LLOYD is:

- i. GEORGINA¹² LLOYD.

141. ALAN L¹¹ DOVE (*LOUISE JULIE¹⁰ FRANCIS, JULIE LOUISA⁹ VALENTINE, COLEMAN (COLONIMUS) HENRIQUES⁸, ISAAC HENRIQUES⁷, EMANUEL DE MOSES HENRIQUES⁶, MOSES HENRIQUES⁵, DAVID HENRIQUES⁴, MOSHE (MOSES) HENRIQUES³, DANIEL HENRIQUES², ? (THE SHEPHARDI) HENRIQUES¹*) was born 11 Nov 1943 in Ilford, Essex. He married LINDA HALLIDAY. She was born 14 Feb.

Children of ALAN DOVE and LINDA HALLIDAY are:

- i. ESTER¹² DOVE, b. 19 Oct 1976.
- ii. ALEXIS DOVE, b. 08 Nov 1974; m. DAVID NICHOLS.

142. LESLIE¹¹ DOVE (*LOUISE JULIE¹⁰ FRANCIS, JULIE LOUISA⁹ VALENTINE, COLEMAN (COLONIMUS) HENRIQUES⁸, ISAAC HENRIQUES⁷, EMANUEL DE MOSES HENRIQUES⁶, MOSES HENRIQUES⁵, DAVID HENRIQUES⁴, MOSHE (MOSES) HENRIQUES³, DANIEL HENRIQUES², ? (THE SHEPHARDI) HENRIQUES¹*) He married DIANNE KELLY.

Children of LESLIE DOVE and DIANNE KELLY are:

- i. BENJAMIN¹² DOVE.
- ii. FRANCESCA DOVE.
- iii. TIMOTHY DOVE.
- iv. ABIGAIL DOVE.

143. MICHAEL¹¹ WILLIAMS (*GILBERT DOUGLAS¹⁰, JANE DAVIS⁹ VALENTINE, COLEMAN (COLONIMUS) HENRIQUES⁸, ISAAC HENRIQUES⁷, EMANUEL DE MOSES HENRIQUES⁶, MOSES HENRIQUES⁵, DAVID HENRIQUES⁴, MOSHE (MOSES) HENRIQUES³, DANIEL HENRIQUES², ? (THE SHEPHARDI) HENRIQUES¹*) He married JUNE ?.

Child of MICHAEL WILLIAMS and JUNE ? is:

- i. AARON¹² WILLIAMS.

144. KEITH F¹¹ BENNETT (*DORIS NELLIE¹⁰ WILLIAMS, JANE DAVIS⁹ VALENTINE, COLEMAN (COLONIMUS) HENRIQUES⁸, ISAAC HENRIQUES⁷, EMANUEL DE MOSES HENRIQUES⁶, MOSES HENRIQUES⁵, DAVID HENRIQUES⁴, MOSHE (MOSES) HENRIQUES³, DANIEL HENRIQUES², ? (THE SHEPHARDI) HENRIQUES¹*) was born 1943 in Chelmsford, Essex. He married VALERIE ?.

Children of KEITH BENNETT and VALERIE ? are:

- i. MARK¹² BENNET.
- ii. DEBRA BENNET.
- iii. CLIVE BENNET.

145. GERALD J¹¹ TOFF (*JACOB (JACK)¹⁰, REBECCA⁹ VALENTINE, ABRAHAM HENRIQUES⁸, ISAAC HENRIQUES⁷, EMANUEL DE MOSES HENRIQUES⁶, MOSES HENRIQUES⁵, DAVID HENRIQUES⁴, MOSHE (MOSES) HENRIQUES³, DANIEL HENRIQUES², ? (THE SHEPHARDI) HENRIQUES¹*) was born 1932 in Woolich, London. He married KIKUE ?.

Children of GERALD TOFF and KIKUE ? are:

- i. MIKA¹² TOFF.
- ii. RIMEI TOFF.
- iii. RUNI TOFF.

146. JOSEPH DENNIS¹¹ TOFF (*ABRAHAM (ALFRED)*¹⁰, *REBECCA*⁹ *VALENTINE*, *ABRAHAM HENRIQUES*⁸, *ISAAC HENRIQUES*⁷, *EMANUEL DE MOSES HENRIQUES*⁶, *MOSES HENRIQUES*⁵, *DAVID HENRIQUES*⁴, *MOSHE (MOSES) HENRIQUES*³, *DANIEL HENRIQUES*², ? (*THE SHEPHARDI HENRIQUES*¹) was born 31 Dec 1926 in Hackney, London. He married JACQUELINE TIBBER 1953 in Marylebone, London.

Children of JOSEPH TOFF and JACQUELINE TIBBER are:

155. i. NICHOLAS JAMES¹² TOFF, b. 1955, London.
156. ii. WILLIAM DANIEL TOFF, b. 1956, London.
157. iii. PENELOPE REBECCA TOFF, b. 1961, London.

147. SHEILA¹¹ TOFF (*ABRAHAM (ALFRED)*¹⁰, *REBECCA*⁹ *VALENTINE*, *ABRAHAM HENRIQUES*⁸, *ISAAC HENRIQUES*⁷, *EMANUEL DE MOSES HENRIQUES*⁶, *MOSES HENRIQUES*⁵, *DAVID HENRIQUES*⁴, *MOSHE (MOSES) HENRIQUES*³, *DANIEL HENRIQUES*², ? (*THE SHEPHARDI HENRIQUES*¹) was born 1931 in Romford, Essex. She married (1) CYRIL SHERWOOD Apr 1954 in Stepney, London. She married (2) WIM ZUYDAM 1959.

Children of SHEILA TOFF and WIM ZUYDAM are:

158. i. MEL¹² ZUYDAM.
- ii. ANNETTE ZUYDAM, m. ASHLEY WILMOT.

148. BARBARA¹¹ COLLYER (*KATE (KITTY)*¹⁰ *TOFF*, *ANNIE*⁹ *VALENTINE*, *ABRAHAM HENRIQUES*⁸, *ISAAC HENRIQUES*⁷, *EMANUEL DE MOSES HENRIQUES*⁶, *MOSES HENRIQUES*⁵, *DAVID HENRIQUES*⁴, *MOSHE (MOSES) HENRIQUES*³, *DANIEL HENRIQUES*², ? (*THE SHEPHARDI HENRIQUES*¹) She married ALAN KILCOYNE.

Children of BARBARA COLLYER and ALAN KILCOYNE are:

- i. DEBORAH¹² KILCOYNE.
- ii. STEPHEN KILCOYNE.

149. ROSANNE¹¹ BAUM (*HENRY (HARRY)*¹⁰, *HANNAH*⁹ *LEVY*, *SARAH CONSTANCE ENRIQUES*⁸ *VALENTINE*, *SAUL HENRIQUES*⁷, *EMANUEL DE MOSES HENRIQUES*⁶, *MOSES HENRIQUES*⁵, *DAVID HENRIQUES*⁴, *MOSHE (MOSES) HENRIQUES*³, *DANIEL HENRIQUES*², ? (*THE SHEPHARDI HENRIQUES*¹) was born 12 Sep 1937 in 8 Marywood Square, Glasgow, Scotland. She married VICTOR JOHN SMITH, son of SIMON SMITH and FANNY TWEKER. He was born 1933 in London, England.

Children of ROSANNE BAUM and VICTOR SMITH are:

159. i. MARK HOWARD¹² SMITH, b. 05 Feb 1963, London, England.
- ii. SEYMOUR SMITH, b. Sep 1969, London, England; d. Jul 1972, London.
160. iii. LEWIS SMITH, b. 05 Feb 1962, London, England.

150. WALTER ALAN¹¹ DAVIS (*BENVENIDA SOLIS BRICKNER*¹⁰ *RITTERBAND*, *SARAH (SALLY) MANESS*⁹, *BENVENIDA*⁸ *SOLIS*, *JACOB DA SILVA*⁷, *BENVENIDA DE ISAAC HENRIQUES*⁶ *VALENTINE*, *MOSES HENRIQUES*⁵, *DAVID HENRIQUES*⁴, *MOSHE (MOSES) HENRIQUES*³, *DANIEL HENRIQUES*², ? (*THE SHEPHARDI HENRIQUES*¹) He married BARBARA HARTMAN.

Children of WALTER DAVIS and BARBARA HARTMAN are:

- i. JOHN¹² DAVIS.
- ii. PATRICIA DAVIS.

151. MILDRED¹¹ FIRTH (*BENVENIDA SOLIS*¹⁰ *RITTERBAND*, *MOSES MANESS*⁹, *BENVENIDA*⁸ *SOLIS*, *JACOB DA SILVA*⁷, *BENVENIDA DE ISAAC HENRIQUES*⁶ *VALENTINE*, *MOSES HENRIQUES*⁵, *DAVID HENRIQUES*⁴, *MOSHE (MOSES) HENRIQUES*³, *DANIEL HENRIQUES*², ? (*THE SHEPHARDI HENRIQUES*¹) was born 13 Mar 1896 in Chicago, Illinois, and died 17 Nov 1978 in Beverly Hills, California. She married ELIAS VICTOR ROSENKRANZ 15 May 1919 in Los Angeles, California. He was born 27 Dec 1888 in Warsaw, Poland, and died 17 Nov 1930 in Beverly Hills, California.

Children of MILDRED FIRTH and ELIAS ROSENKRANZ are:

161. i. MARJORIE RUTH¹² ROSENKRANZ.
- ii. ELAINE VICTORIA ROSENKRANZ, m. AL BARON.
- iii. DOROTHY JUNE ROSENKRANZ, b. 27 Jun 1920, Los Angeles, California; d. 15 Apr 1975, Brentwood, California.

152. ROBERT MANESS¹¹ RITTERBAND (*LEON MANESS*¹⁰, *MOSES MANESS*⁹, *BENVENIDA*⁸ *SOLIS*, *JACOB DA SILVA*⁷, *BENVENIDA DE ISAAC HENRIQUES*⁶ *VALENTINE*, *MOSES HENRIQUES*⁵, *DAVID HENRIQUES*⁴, *MOSHE (MOSES) HENRIQUES*³, *DANIEL HENRIQUES*², ? (*THE SHEPHARDI HENRIQUES*¹) was born 16 Jun 1909 in Chicago, Illinois, and died 21 May 2000 in Los Angeles, California. He married (1) JEAN SCHARLACK 28 Jun 1931. She was born 08 Mar 1910 in San Antonio, Texas, and died 04 Oct 1942 in Los Angeles, California. He married (2) MOLLY BURSTEIN 15 Sep 1946 in Santa Monica, California. She was born 17 Aug 1918 in Dvinsk (?), Ukraine, and died Jan 2003.

Children of ROBERT RITTERBAND and JEAN SCHARLACK are:

162. i. LAWRENCE MYRON¹² RITTERBAND.
163. ii. PHILIP MANESS RITTERBAND, b. 11 Oct 1937; d. 24 Apr 1972.

Child of ROBERT RITTERBAND and MOLLY BURSTEIN is:

- iii. ALLAN JAMES¹² RITTERBAND.

Generation No. 12

153. FIONA MAY¹² OOI (*LYNETTE MARGARET*¹¹ *HANDRICKS*, *NORMA MARGARET LOUISA*¹⁰ *HARRIS*, *MARGARET MIRIAM (MAY)*⁹ *VALENTINE*, *COLEMAN (COLONIMUS) HENRIQUES*⁸, *ISAAC HENRIQUES*⁷, *EMANUEL DE MOSES HENRIQUES*⁶, *MOSES HENRIQUES*⁵, *DAVID HENRIQUES*⁴, *MOSHE (MOSES) HENRIQUES*³, *DANIEL HENRIQUES*², ? (*THE SHEPHARDI HENRIQUES*¹) was born 22 Mar 1984 in Auckland. She married ANTONIO MASTELLONE 19 Oct 2014 in Massa Lubrense, Italy.

Child of FIONA OOI and ANTONIO MASTELLONE is:

- i. SILVANA¹³ MASTELLONE, b. 05 Jan 2016, Italy.

154. JASON MATTHEW¹² VALENTINE (*DAVID ARTHUR*¹¹, *WILLIAM COLEMAN*¹⁰, *ARTHUR ISAAC*⁹, *COLEMAN (COLONIMUS) HENRIQUES*⁸, *ISAAC HENRIQUES*⁷, *EMANUEL DE MOSES HENRIQUES*⁶, *MOSES HENRIQUES*⁵, *DAVID HENRIQUES*⁴, *MOSHE (MOSES) HENRIQUES*³, *DANIEL HENRIQUES*², ? (*THE SHEPHARDI HENRIQUES*¹) was born 30 Aug 1969 in Barking, Essex. He married ANNETTE CUNNINGHAM 23 Mar 2002 in St Mary's, Haxby, York. She was born 1963 in Rotherham.

Child of JASON VALENTINE and ANNETTE CUNNINGHAM is:

- i. ELEN GRACE¹³ VALENTINE, b. 03 Feb 2004, York District Hospital.

155. NICHOLAS JAMES¹² TOFF (*JOSEPH DENNIS*¹¹, *ABRAHAM (ALFRED)*¹⁰, *REBECCA*⁹ *VALENTINE*, *ABRAHAM HENRIQUES*⁸, *ISAAC HENRIQUES*⁷, *EMANUEL DE MOSES HENRIQUES*⁶, *MOSES HENRIQUES*⁵, *DAVID HENRIQUES*⁴, *MOSHE (MOSES) HENRIQUES*³, *DANIEL HENRIQUES*², ? (*THE SHEPHARDI HENRIQUES*¹) was born 1955 in London. He married LOUISE ALLEN.

Children of NICHOLAS TOFF and LOUISE ALLEN are:

- i. ALEXANDER¹³ TOFF.
- ii. GEORGE TOFF.
- iii. CHARLES TOFF.

156. WILLIAM DANIEL¹² TOFF (*JOSEPH DENNIS*¹¹, *ABRAHAM (ALFRED)*¹⁰, *REBECCA*⁹ *VALENTINE*, *ABRAHAM HENRIQUES*⁸, *ISAAC HENRIQUES*⁷, *EMANUEL DE MOSES HENRIQUES*⁶, *MOSES HENRIQUES*⁵, *DAVID HENRIQUES*⁴, *MOSHE (MOSES) HENRIQUES*³, *DANIEL HENRIQUES*², ? (*THE SHEPHARDI HENRIQUES*¹) was born 1956 in London. He married HARRIETT STREVENS.

Child of WILLIAM TOFF and HARRIETT STREVENS is:

- i. SOPHIE¹³ TOFF.

157. PENELOPE REBECCA¹² TOFF (*JOSEPH DENNIS¹¹, ABRAHAM (ALFRED)¹⁰, REBECCA⁹ VALENTINE, ABRAHAM HENRIQUES⁸, ISAAC HENRIQUES⁷, EMANUEL DE MOSES HENRIQUES⁶, MOSES HENRIQUES⁵, DAVID HENRIQUES⁴, MOSHE (MOSES) HENRIQUES³, DANIEL HENRIQUES², ? (THE SHEPHARDI) HENRIQUES¹*) was born 1961 in London. She met ? LUZ.

Child of PENELOPE TOFF and ? LUZ is:

- i. NANCY¹³ LUZ-TOFF.

158. MEL¹² ZUYDAM (*SHEILA¹¹ TOFF, ABRAHAM (ALFRED)¹⁰, REBECCA⁹ VALENTINE, ABRAHAM HENRIQUES⁸, ISAAC HENRIQUES⁷, EMANUEL DE MOSES HENRIQUES⁶, MOSES HENRIQUES⁵, DAVID HENRIQUES⁴, MOSHE (MOSES) HENRIQUES³, DANIEL HENRIQUES², ? (THE SHEPHARDI) HENRIQUES¹*) He married MELISSA JONES.

Children of MEL ZUYDAM and MELISSA JONES are:

- i. ISABEL¹³ ZUYDAM.
- ii. BEN ZUYDAM.

164. iii. ANNETTE CAROLINE ZUYDAM.

159. MARK HOWARD¹² SMITH (*ROSANNE¹¹ BAUM, HENRY (HARRY)¹⁰, HANNAH⁹ LEVY, SARAH CONSTANCE ENRIQUES⁸ VALENTINE, SAUL HENRIQUES⁷, EMANUEL DE MOSES HENRIQUES⁶, MOSES HENRIQUES⁵, DAVID HENRIQUES⁴, MOSHE (MOSES) HENRIQUES³, DANIEL HENRIQUES², ? (THE SHEPHARDI) HENRIQUES¹*) was born 05 Feb 1963 in London, England. He married KAREN HEATHER ZIEGLER 04 Aug 1991 in London, England, daughter of JOHN ZIEGLER and LORNA SHER. She was born 15 Jun 1966 in London, England.

Children of MARK SMITH and KAREN ZIEGLER are:

- i. GEORGINA TILLY¹³ SMITH, b. 18 Mar 1997, Westminster, London.
- ii. CLAUDIA EMILY SMITH, b. 23 Dec 1999, Vale of Health, Hampstead, London.

160. LEWIS¹² SMITH (*ROSANNE¹¹ BAUM, HENRY (HARRY)¹⁰, HANNAH⁹ LEVY, SARAH CONSTANCE ENRIQUES⁸ VALENTINE, SAUL HENRIQUES⁷, EMANUEL DE MOSES HENRIQUES⁶, MOSES HENRIQUES⁵, DAVID HENRIQUES⁴, MOSHE (MOSES) HENRIQUES³, DANIEL HENRIQUES², ? (THE SHEPHARDI) HENRIQUES¹*) was born 05 Feb 1962 in London, England. He married MANDY CAPLAN. She was born 1961 in Manchester, Lancashire, England.

Children of LEWIS SMITH and MANDY CAPLAN are:

- i. KIMBERLEY¹³ SMITH, b. Sep 1989, London, England.
- ii. RYAN SMITH, b. Jul 1992, London, England.

161. MARJORIE RUTH¹² ROSENKRANZ (*MILDRED¹¹ FIRTH, BENVENIDA SOLIS¹⁰ RITTERBAND, MOSES MANESS⁹, BENVENIDA⁸ SOLIS, JACOB DA SILVA⁷, BENVENIDA DE ISAAC HENRIQUES⁶ VALENTINE, MOSES HENRIQUES⁵, DAVID HENRIQUES⁴, MOSHE (MOSES) HENRIQUES³, DANIEL HENRIQUES², ? (THE SHEPHARDI) HENRIQUES¹*) She married (1) MORRIS KAWIN. He was born 1919, and died 1997. She married (2) HERSHEL TOOMIN.

Children of MARJORIE ROSENKRANZ and MORRIS KAWIN are:

165. i. ELISE¹³ KAWIN.
- ii. BRUCE KAWIN.

162. LAWRENCE MYRON¹² RITTERBAND (*ROBERT MANESS¹¹, LEON MANESS¹⁰, MOSES MANESS⁹, BENVENIDA⁸ SOLIS, JACOB DA SILVA⁷, BENVENIDA DE ISAAC HENRIQUES⁶ VALENTINE, MOSES HENRIQUES⁵, DAVID HENRIQUES⁴, MOSHE (MOSES) HENRIQUES³, DANIEL HENRIQUES², ? (THE SHEPHARDI) HENRIQUES¹*) He married (1) MARSHA ANNE FRANK. He married (2) WENDY GRONER.

Children of LAWRENCE RITTERBAND and MARSHA FRANK are:

166. i. LEE MICHAEL¹³ RITTERBAND.
- ii. EDITH PHILENE RITTERBAND.

163. PHILIP MANESS¹² RITTERBAND (*ROBERT MANESS¹¹, LEON MANESS¹⁰, MOSES MANESS⁹, BENVENIDA⁸ SOLIS, JACOB DA SILVA⁷, BENVENIDA DE ISAAC HENRIQUES⁶ VALENTINE, MOSES HENRIQUES⁵, DAVID HENRIQUES⁴, MOSHE (MOSES) HENRIQUES³, DANIEL HENRIQUES², ? (THE SHEPHARDI) HENRIQUES¹*) was born 11 Oct 1937, and died 24 Apr 1972. He married ELAINE FRIEDA BERETZ.

Children of PHILIP RITTERBAND and ELAINE BERETZ are:

167. i. JULIE JEAN¹³ RITTERBAND.
- ii. DAVID MAURICE RITTERBAND, m. MELISSA.

Generation No. 13

164. ANNETTE CAROLINE¹³ ZUYDAM (*MEL¹², SHEILA¹¹ TOFF, ABRAHAM (ALFRED)¹⁰, REBECCA⁹ VALENTINE, ABRAHAM HENRIQUES⁸, ISAAC HENRIQUES⁷, EMANUEL DE MOSES HENRIQUES⁶, MOSES HENRIQUES⁵, DAVID HENRIQUES⁴, MOSHE (MOSES) HENRIQUES³, DANIEL HENRIQUES², ? (THE SHEPHARDI) HENRIQUES¹*) She married ASHLEY WILMOT.

Children of ANNETTE ZUYDAM and ASHLEY WILMOT are:

- i. AARON¹⁴ WILMOT.
- ii. NATHAN WILMOT.

165. ELISE¹³ KAWIN (*MARJORIE RUTH¹² ROSENKRANZ, MILDRED¹¹ FIRTH, BENVENIDA SOLIS¹⁰ RITTERBAND, MOSES MANESS⁹, BENVENIDA⁸ SOLIS, JACOB DA SILVA⁷, BENVENIDA DE ISAAC HENRIQUES⁶ VALENTINE, MOSES HENRIQUES⁵, DAVID HENRIQUES⁴, MOSHE (MOSES) HENRIQUES³, DANIEL HENRIQUES², ? (THE SHEPHARDI) HENRIQUES¹*) She married GEORGE OSNER.

Children of ELISE KAWIN and GEORGE OSNER are:

168. i. JEREMY¹⁴ OSNER.
169. ii. GABRIEL SOLIS.
170. iii. BLYTHE OSNER.
- iv. MIRIAM OSNER.

166. LEE MICHAEL¹³ RITTERBAND (*LAWRENCE MYRON¹², ROBERT MANESS¹¹, LEON MANESS¹⁰, MOSES MANESS⁹, BENVENIDA⁸ SOLIS, JACOB DA SILVA⁷, BENVENIDA DE ISAAC HENRIQUES⁶ VALENTINE, MOSES HENRIQUES⁵, DAVID HENRIQUES⁴, MOSHE (MOSES) HENRIQUES³, DANIEL HENRIQUES², ? (THE SHEPHARDI) HENRIQUES¹*) He married DAWN KREHBIEL.

Child of LEE RITTERBAND and DAWN KREHBIEL is:

- i. MAXWELL JACOB¹⁴ RITTERBAND.

167. JULIE JEAN¹³ RITTERBAND (*PHILIP MANESS¹², ROBERT MANESS¹¹, LEON MANESS¹⁰, MOSES MANESS⁹, BENVENIDA⁸ SOLIS, JACOB DA SILVA⁷, BENVENIDA DE ISAAC HENRIQUES⁶ VALENTINE, MOSES HENRIQUES⁵, DAVID HENRIQUES⁴, MOSHE (MOSES) HENRIQUES³, DANIEL HENRIQUES², ? (THE SHEPHARDI) HENRIQUES¹*) She married KEN LORD.

Children of JULIE RITTERBAND and KEN LORD are:

- i. RAYMOND PHILIP¹⁴ LORD.
- ii. JOSEPH LAWRENCE LORD.

Generation No. 14

168. JEREMY¹⁴ OSNER (*ELISE¹³ KAWIN, MARJORIE RUTH¹² ROSENKRANZ, MILDRED¹¹ FIRTH, BENVENIDA SOLIS¹⁰ RITTERBAND, MOSES MANESS⁹, BENVENIDA⁸ SOLIS, JACOB DA SILVA⁷, BENVENIDA DE ISAAC HENRIQUES⁶ VALENTINE, MOSES HENRIQUES⁵, DAVID HENRIQUES⁴, MOSHE (MOSES) HENRIQUES³, DANIEL HENRIQUES², ? (THE SHEPHARDI) HENRIQUES¹*) He married ELLEN KAHANER.

Child of JEREMY OSNER and ELLEN KAHANER is:

- i. SYLVIA¹⁵ OSNER.

169. GABRIEL¹⁴ SOLIS (*ELISE*¹³ *KAWIN*, *MARJORIE RUTH*¹² *ROSENKRANZ*, *MILDRED*¹¹ *FIRTH*, *BENVENIDA SOLIS*¹⁰ *RITTERBAND*, *MOSES MANESS*⁹, *BENVENIDA*⁸ *SOLIS*, *JACOB DA SILVA*⁷, *BENVENIDA DE ISAAC HENRIQUES*⁶ *VALENTINE*, *MOSES HENRIQUES*⁵, *DAVID HENRIQUES*⁴, *MOSHE (MOSES) HENRIQUES*³, *DANIEL HENRIQUES*², ? (*THE SHEPHARDI HENRIQUES*¹) He married ELLEN.

Children of GABRIEL SOLIS and ELLEN are:

- i. COLEMAN¹⁵ SOLIS.
- ii. ISABELLA ("BELLA") SOLIS.

170. BLYTHE¹⁴ OSNER (*ELISE*¹³ *KAWIN*, *MARJORIE RUTH*¹² *ROSENKRANZ*, *MILDRED*¹¹ *FIRTH*, *BENVENIDA SOLIS*¹⁰ *RITTERBAND*, *MOSES MANESS*⁹, *BENVENIDA*⁸ *SOLIS*, *JACOB DA SILVA*⁷, *BENVENIDA DE ISAAC HENRIQUES*⁶ *VALENTINE*, *MOSES HENRIQUES*⁵, *DAVID HENRIQUES*⁴, *MOSHE (MOSES) HENRIQUES*³, *DANIEL HENRIQUES*², ? (*THE SHEPHARDI HENRIQUES*¹) She married CRAIG SAWYER.

Child of BLYTHE OSNER and CRAIG SAWYER is:

- i. ISAIAH¹⁵ SAWYER.

